

TANTI STILI UNA PASSIONE - SEVERAL STYLES ONE PASSION

espresso coffee machines

LA PAZIALE

S8.S9
DSP

EK - EP - T.A. - COMPACT

S8 DSP EK



Disponibile in versione **2 • 3 • 4** Gruppi

Available in **2 • 3 • 4** group version

e s p r e s s o c o f

S9 DSP EK



Disponibile in versione **2 • 3 • 4** Gruppi

Available in **2 • 3 • 4** group version

GOLD



e s p r e s s o c o f

Versione **T.A.** (Take Away)



Versione **EP** (Semiautomatica • Semiautomatic)



f e e m a c h i n e s

OPTIONALS

OPTIONS • OPCIONES



MAT

- Sistema automatico di **emulsione del latte** con temperatura regolabile
- Automatic system for **milk emulsion** with adjustable temperature
- Système automatique pour **l'émulsion du lait** avec température réglable
- Sistema automático para **emulsionar la leche** con temperatura ajustable



AM

- Erogazione **acqua calda miscelata per infusi**
- **Mix temperature** for hot water delivery for **infusions**
- Débit **eau chaude mélangée** pour **infusions**
- Dispensador **agua caliente mezclada** para **infusiones**



ITC

- **Controllo temperatura individuale** gruppi erogatori
- **Individual temperature control** for each delivery group
- **Contrôle température individuel** des groupes de débit
- **Control individual** de la **temperatura** para cada grupo de erogación



GA

- Gestione **interventi tecnici programmati** e **addolcitori a cartuccia**
- Service **scheduled control system** and **water softener cartridge** control
- Gestion des **interventions techniques programmées** et **adoucisseur à cartouche**
- Sistema **programado de control técnico** y **depurador a cartuchos**



S8 • S9 COMPACT

S8 EK

Elettronica
Electronic
Electronique
Electrónica



2

Gruppi
Groups
Groupes
Grupos

S8 EP



Semiautomatica
Semiautomatic
Sémi-automatique
Semiautomática

S9 EP

Semiautomatica
Semiautomatic
Sémi-automatique
Semiautomática



2

Gruppi
Groups
Groupes
Grupos

S9 EK



Elettronica
Electronic
Electronique
Electrónica

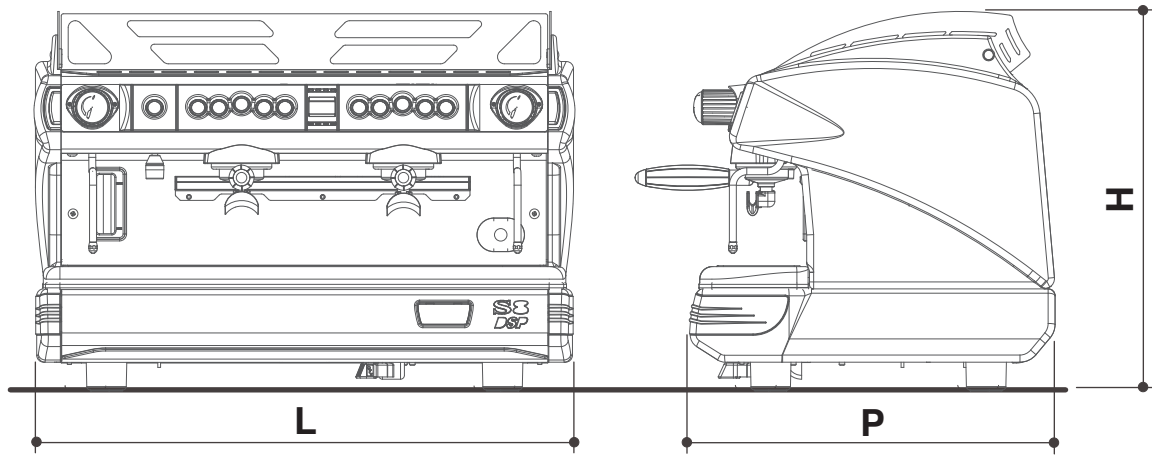

DIMENSIONI • DIMENSIONS DIMENSIONS • DIMENSIONES				
S8 DSP • S9 DSP EK - EP				
		2	3	4
L	(mm/in)	770 30,3"	1000 39,3"	1235 48,6"
H	(mm/in)	520 20,4"	520 20,4"	520 20,4"
P	(mm/in)	530 20,8"	530 20,8"	530 20,8"
PESO - WEIGHT POIDS - PESO (kg/lb)		65 143,30	80 176,36	97 213,84

DIMENSIONI • DIMENSIONS DIMENSIONS • DIMENSIONES				
S8 DSP • S9 DSP EK - EP T.A.				
		2	3	4
L	(mm/in)	770 30,3"	1000 39,3"	1235 48,6"
H	(mm/in)	600 23,6"	600 23,6"	600 23,6"
P	(mm/in)	530 20,8"	530 20,8"	530 20,8"
PESO - WEIGHT POIDS - PESO (kg/lb)		70 154,32	86 189,59	104 229,28

DIMENSIONI • DIMENSIONS DIMENSIONS • DIMENSIONES			
S8 • S9 COMPACT EK - EP		2	
L	(mm/in)	580 22,8"	
H	(mm/in)	520 20,4"	
P	(mm/in)	530 20,8"	
PESO - WEIGHT POIDS - PESO (kg/lb)		54 119,04	

I • S8 • S9 EK - EP DSP • S8 • S9 EK - EP T.A. DSP

- Macchina da caffè elettronica con dosatura programmabile (versione EK)
- Macchina da caffè semiautomatica ad erogazione continua (versione EP)
- Autolivello elettronico
- Riscaldamento elettrico
- Manometro doppia scala per controllo pressione caldaia e motopompa
- 1 lancia acqua calda / 2 lance vapore
- Termoregolazione caldaia elettronica
- Visualizzazione temperatura della caldaia tramite display
- Funzione di incremento automatico della temperatura di lavoro
- Gestione allarmi e anomalie di funzionamento
- Pompa volumetrica incorporata
- Scaldatasse elettrico (a richiesta)
- Resistenza caldaia maggiorata (a richiesta)
- Distanza di 16 cm tra beccucci erogatori e bacinella per l'utilizzo di bicchieri "take away" nella versione S8•S9 EK - EP T.A. DSP
- Grigliette sostegno tazze espresso nella versione S8•S9 EK - EP T.A. DSP
- Funzione ECO MODE
- Illuminazione piano tazze
- Erogazione acqua calda temporizzata

OPTIONALS:

- MAT** Sistema automatico di emulsione del latte con temperatura regolabile
- ITC** Controllo temperatura individuale gruppi erogatori
- AM** Erogazione acqua calda miscelata per infusi
- GA** Gestione interventi tecnici programmati e addolcitori a cartuccia Carrozzeria gold

• **S8•S9 COMPACT EK - EP**

- Macchina da caffè 2 gruppi elettronica con dosatura programmabile (versione EK)
- Macchina da caffè 2 gruppi semiautomatica ad erogazione continua (versione EP)
- Riscaldamento elettrico
- Manometro per controllo pressione caldaia
- Manometro per controllo pressione motopompa
- 1 lancia acqua calda / 2 lance vapore
- Scaldatasse elettrico (a richiesta)
- Gestione allarmi e anomalie di funzionamento
- Pompa volumetrica incorporata
- Resistenza caldaia maggiorata (a richiesta)

GB • S8 • S9 EK - EP DSP • S8 • S9 EK - EP T.A. DSP

- Electronic coffee machine with automatic dose setting (EK)
- Semiautomatic coffee machine with free-flow delivery (EP)
- Electronic boiler refill
- Electric heating system
- Double pressure gauge for boiler and pump pressure control
- 1 hot water outlet / 2 steam wands
- Electronic boiler temperature regulation
- Boiler temperature indicated by LED display
- Automatic operating temperature boost function
- Control of malfunctions alarms
- Built-in volumetric pump
- Electric cup warmer available on request
- Upgraded boiler heating element available on request
- Distance of 16 cm between delivery spouts and drip tray for "take away" cups in the S8•S9 EK - EP T.A. DSP version
- Grids for espresso cups in the S8•S9 EK - EP T.A. DSP version
- ECO MODE Function
- Illumination of cup grid
- Preset hot water delivery for infusions

OPTIONS:

- MAT** Automatic system for milk emulsion with adjustable temperature
- ITC** Individual temperature control for each delivery group
- AM** Mix temperature for hot water delivery for infusions
- GA** Service scheduled control system and water softener cartridge control
- Gold body

• **S8•S9 COMPACT EK - EP**

- Electronic coffee machine 2 groups with automatic dose setting (EK)
- Semiautomatic coffee machine 2 groups with free-flow delivery (EP)
- Electric heating system
- Pressure gauge for boiler pressure control
- Pressure gauge for pump pressure control
- 1 hot water outlet / 2 steam wands
- Electric cup warmer available on request
- Control of malfunctions alarms
- Built-in volumetric pump
- Upgraded boiler heating element available on request

F • S8 • S9 EK - EP DSP • S8 • S9 EK - EP T.A. DSP

- Machine à café électronique à dosage programmable (EK)
- Machine à café semi-automatique à débit continu (EP)
- Auto-niveau électronique
- Chauffage électrique
- Manomètre double échelle pour le contrôle pression chaudière et motopompe
- 1 lance eau chaude / 2 lances vapeur
- Thermo-réglage chaudière électronique
- Visualisation température de la chaudière par display
- Fonction incrément automatique de la température de travail
- Gestion alarmes anomalies de fonctionnement
- Pompe volumétrique incorporée
- Chauffe-tasse électrique (sur demande)
- Résistance chaudière renforcée (sur demande)
- Distance de 16 cm entre les becs de débit et la bassinelle pour les verres "take away" pour les versions S8•S9 EK - EP T.A. DSP
- Grilles pour appuyer les tasses pour l'espresso pour les versions S8•S9 EK - EP T.A. DSP
- Fonction ECO MODE
- Éclairage du plan d'appui tasses
- Débit eau chaude temporisée pour infusions

OPTIONS:

MAT Système automatique pour l'émulsion du lait avec température réglable

ITC Contrôle température individuel des groupes de débit

AM Débit eau chaude mélangée pour infusions

GA Gestion des interventions techniques programmées et adoucisseur à cartouche

Carrosserie gold

• S8•S9 COMPACT EK - EP

- Machine à café électronique 2 groupes à dosage programmable (EK)
- Machine à café semi-automatique 2 groupes à débit continu (EP)
- Chauffage électrique
- Monomètre pour le contrôle pression chaudière
- Monomètre pour le contrôle pression motopompe
- 1 lance eau chaude / 2 lances vapeur
- Chauffe-tasse électrique (sur demande)
- Gestion alarmes anomalies de fonctionnement
- Pompe volumétrique incorporée
- Résistance chaudière renforcée (sur demande)

E • S8 • S9 EK - EP DSP • S8 • S9 EK - EP T.A. DSP

- Máquina de café electrónica con erogador dosificado programable (EK)
- Máquina de café semiautomática con erogación continua (EP)
- Autonivel electrónico
- Calentamiento eléctrico
- Manómetro doble escala para el control de presión de caldera y motobomba
- 1 salida agua caliente / 2 tubos vapor
- Termostato electrónico en caldera
- Visualización temperatura de la caldera a través de display
- Función de incremento automático de la temperatura de trabajo
- Gestión alarmas averías de funcionamiento
- Motobomba volumétrica incorporada
- Calienta tazas eléctrico (sobre pedido)
- Resistencia caldera mayorada (sobre pedido)
- Distancia de 16 cm entre las salidas de erogación y la bandeja para los cristales "take away" sólo para versión S8•S9 EK - EP T.A. DSP
- Rejillas para apoyar las tazas por el café espresso sólo para versión S8•S9 EK - EP T.A. DSP
- Función modalidad ECO
- Iluminación bandeja apoya tazas
- Erogación agua caliente temporizada para infusiones

OPCIONES:

MAT Sistema automático para emulsionar la leche con temperatura ajustable

ITC Control individual de la temperatura para cada grupo de erogación



AM Dispensador agua caliente mezclada para infusiones



GA Sistema programado de control técnico y depurador a cartuchos



Cuerpo gold

• S8•S9 COMPACT EK - EP

- Máquina de café 2 grupos electrónica programable (EK)
- Máquina de café 2 grupos semiautomática con erogación continua (EP)
- Calentamiento eléctrico
- Manómetro para el control de presión de caldera
- Manómetro para el control de presión de motobomba
- 1 salida agua caliente / 2 tubos vapor
- Calienta tazas eléctrico (sobre pedido)
- Gestión alarmas averías de funcionamiento
- Motobomba volumétrica incorporada
- Resistencia caldera mayorada (sobre pedido)

S8 DSP • S9 DSP EK - EP			
CAPACITÀ CALDAIA - BOILER CAPACITY CAPACITE CHAUDIERE - CAPACIDAD CALDERA			
	2	3	4
Litri - Liters Litres - Litros	10	15	20
ALIMENTAZIONE ED ASSORBIMENTO POWER SUPPLY AND POWER ABSORPTION ALIMENTATION ET ABSORPTION ALIMENTACIÓN Y ABSORBIMIENTO			
	2	3	4
Volt	400/220-240	400/220-240	400
Hz	50/60	50/60	50/60
W	3300	4300	6300
W+	3800	6300 (400V)	-

S8 DSP • S9 DSP EK - EP T.A.			
CAPACITÀ CALDAIA - BOILER CAPACITY CAPACITE CHAUDIERE - CAPACIDAD CALDERA			
	2	3	4
Litri - Liters Litres - Litros	10	15	20
ALIMENTAZIONE ED ASSORBIMENTO POWER SUPPLY AND POWER ABSORPTION ALIMENTATION ET ABSORPTION ALIMENTACIÓN Y ABSORBIMIENTO			
	2	3	4
Volt	400/220-240	400/220-240	400
Hz	50/60	50/60	50/60
W	3300	4300	6300
W+	3800	6300 (400V)	-

S8 • S9 COMPACT EK - EP		
CAPACITÀ CALDAIA - BOILER CAPACITY CAPACITE CHAUDIERE - CAPACIDAD CALDERA		
	2	
Litri - Liters Litres - Litros	5	
ALIMENTAZIONE ED ASSORBIMENTO POWER SUPPLY AND POWER ABSORPTION ALIMENTATION ET ABSORPTION ALIMENTACIÓN Y ABSORBIMIENTO		
	2	
Volt	220-240	115
Hz	50/60	50/60
W	3000	2300
W+	3800	-

Il costruttore si riserva il diritto di modificare senza preavviso le caratteristiche delle apparecchiature trattate in questa pubblicazione.
The manufacturer reserves the right to modify the features of the appliances described in this brochure with no prior notice.
Le fabricant se réserve le droit de modifier sans préavis les caractéristiques des appareils présentés dans cette publication.
El fabricante se reserva el derecho de modificar sin preaviso las características de las máquinas tratadas en esta publicación.

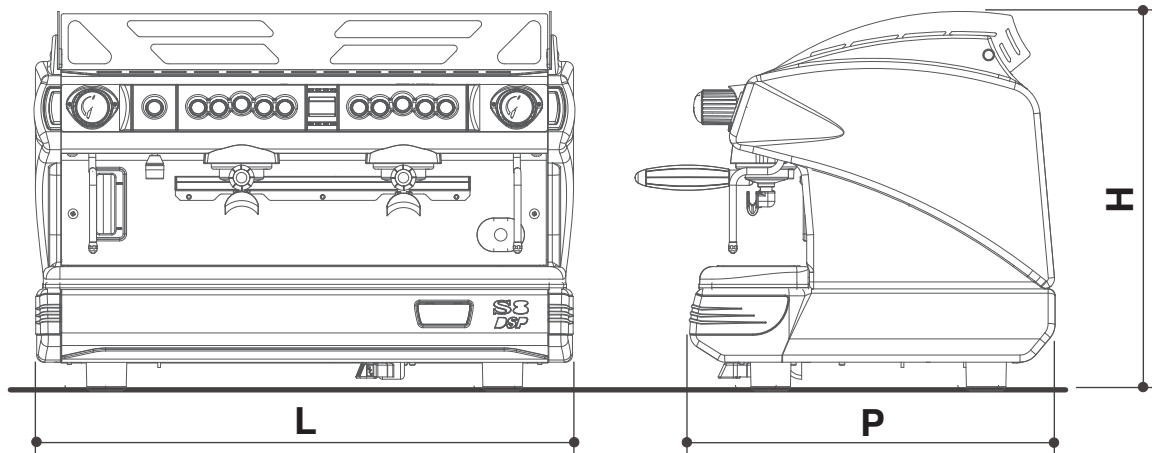

ABMESSUNGEN • DIMENSÕES РАЗМЕРЫ • 尺寸				
S8 DSP • S9 DSP EK - EP				
		2	3	4
L	(mm/in)	770 30,3"	1000 39,3"	1235 48,6"
H	(mm/in)	520 20,4"	520 20,4"	520 20,4"
P	(mm/in)	530 20,8"	530 20,8"	530 20,8"
GEWICHT - PESO (kg/lb) BEC - 重量		65 143,30	80 176,36	97 213,84

ABMESSUNGEN • DIMENSÕES РАЗМЕРЫ • 尺寸				
S8 DSP • S9 DSP EK - EP T.A.				
		2	3	4
L	(mm/in)	770 30,3"	1000 39,3"	1235 48,6"
H	(mm/in)	600 23,6"	600 23,6"	600 23,6"
P	(mm/in)	530 20,8"	530 20,8"	530 20,8"
GEWICHT - PESO (kg/lb) BEC - 重量		70 154,32	86 189,59	104 229,28

ABMESSUNGEN • DIMENSÕES РАЗМЕРЫ • 尺寸			
S8 • S9 COMPACT EK - EP		2	
L	(mm/in)	580 22,8"	
H	(mm/in)	520 20,4"	
P	(mm/in)	530 20,8"	
GEWICHT - PESO (kg/lb) BEC - 重量		54 119,04	

D • S8 • S9 EK - EP DSP • S8 • S9 EK - EP T.A. DSP

- Elektronische Kaffeemaschine mit programmierbarer Dosierung (Reihe EK)
- Halbautomatische Kaffeemaschine mit dauernder Ausgabe (Reihe EP)
- Automatische Kesselfüllung
- Elektrische Heizanlage
- Doppelmanometer für Kessel- und Pumpendruckkontrolle
- 1 Heißwasserauslaßdüse / 1 Dampfauslaßdüse
- Elektronische Kesseltemperaturkontrolle
- Anzeige Kesseltemperatur erreicht durch Display
- Funktion der automatischen Betriebstemperaturzunahme
- Alarmsführung für Betriebsunregelmäßigkeiten
- Eingebaute volumetrische Pumpe
- Elektrischer Tassenwärmer (auf Befragen)
- Erhöhter Kesselheizungskörper (auf Befragen)
- 16cm zwischen Kaffeeausgüssen und Wasserschale zur Benützung "take away" Gläser (Reihe S8•S9 EK - EP T.A. DSP)
- Espressoablagen (Reihe S8•S9 EK - EP T.A. DSP)
- Funktion ECO MODE
- Beleuchtung der Tassenablage
- Programmierbare Heißwasserausgabe durch Zeit gesteuert

OPTIONALS:

- MAT** Automatische Milchemulsion mit regulierbarer Temperatur
ITC Individuelle Temperaturkontrolle der Ausgabegruppen
AM Gemischte Heißwasserentnahme für Aufgüsse
GA System für programmierte technische Kontrolle und Wasserenthärter
 Goldene Karosserie

• S8 • S9 COMPACT EK - EP

- Zweigruppige Kaffeemaschine mit programmierbarer Dosierung (Reihe EK)
- Zweigruppige Halbautomatische Kaffeemaschine mit dauernder Ausgabe (Reihe EP)
- Elektrische Heizanlage
- Manometer für Kesseldruckkontrolle
- Manometer für Pumpendruckkontrolle
- 1 Heißwasserauslaßdüse / 1 Dampfauslaßdüse
- Elektrischer Tassenwärmer (auf Befragen)
- Alarmsführung für Betriebsunregelmäßigkeiten
- Eingebaute volumetrische Pumpe
- Erhöhter Kesselheizungskörper (auf Befragen)

P • S8 • S9 EK - EP DSP • S8 • S9 EK - EP T.A. DSP

- Máquina de café eletrônica com dosagem programável (versão EK)
- Máquina de café semi-automática a distribuição contínua (versão EP)
- Auto-nível eletrônico de série
- Aquecimento elétrico
- Manômetro dupla escala para o controle da pressão da caldeira e moto bomba
- 1 saída para água quente / 2 saídas para vapor
- Termo regulador da caldeira elétrico ou termostato de segurança da parte elétrica de série
- Visualizador da temperatura da caldeira por display
- Função de aumento automático da temperatura de trabalho
- Gestão de alarme e anomalias de funcionamento
- Bomba volumétrica incorporada
- Aquecimento de xícaras elétrico (opcional feito sob pedido)
- Resistência da caldeira aumentada (opcional feito sob pedido)
- Distância de 16 cm entre a saída do porta filtro do café e bacia para o utilize de copos "take away" na versão S8•S9 EK - EP T.A. DSP
- Grelhas porta-xícaras de expresso na versão S8•S9 EK - EP T.A. DSP
- Função modo eco
- Iluminação do local das xícaras
- Erogção da temporizada água quente para cha

OPCIONAIS:

- MAT** Sistema automático de emulsão de leite com temperatura regulável
ITC Controle de temperatura individual dos grupos "distribuidores"
AM Erogção misturada da água quente para cha
GA Pré-disposição para gestão de intervenções técnicas programadas e depurador de água a cartucho
 Carroçeria dourada

• S8 • S9 COMPACT EK - EP

- Máquina de café 2 grupos eletrônica com dosagem programável (versão EK)
- Máquina de café 2 grupos semi automática a distribuição contínua (versão EP)
- Aquecimento elétrico
- Manômetro para o controle da pressão da caldeira
- Manômetro para o controle da pressão da moto bomba
- 1 saída para água quente / 2 saídas para vapor
- Aquecimento de xícaras elétrico (opcional feito sob pedido)
- Gestão de alarme e anomalias de funcionamento
- Bomba volumétrica incorporada
- Resistência da caldeira aumentada (opcional feita sob pedido)

RU • Серия S8•S9 EK - EP DSP • Серия S8•S95 EK - EP T.A. DSP

- КОФЕ МАШИНА ЭЛЕКТРОННАЯ С ПРОГРАММИРУЕМОЙ НАСТРОЙКОЙ ДОЗИРОВКИ (ВЕРСИЯ EK)
- КОФЕ МАШИНА ПОЛУАВТОМАТ С ПОСТОЯННОЙ ПОДАЧЕЙ ВОДЫ (ВЕРСИЯ EP)
- АВТОМАТИЧЕСКИЙ ЭЛЕКТРОННЫЙ УРОВЕНЬ
- ЭЛЕКТРИЧЕСКИЙ ПОДОГРЕВ
- МАНОМЕТР С ДВОЙНОЙ ШКАЛОЙ ДЛЯ ИЗМЕРЕНИЯ ДАВЛЕНИЯ В БОЙЛЕРЕ И В МОТОНАСОСЕ
- 1 ВЫБРОС ГОРЯЧЕЙ ВОДЫ/ 2-А ВЫБРОСА ПАРА
- ЭЛЕКТРОННЫЙ РЕГУЛЯТОР ТЕМПЕРАТУРЫ БОЙЛЕРА
- ПОКАЗАНИЕ ДАННЫХ ТЕМПЕРАТУРЫ БОЙЛЕРА ПРИ ПОМОЩИ БАРОГРАФА С ПОДСВЕТКОЙ
- ФУНКЦИЯ АВТОМАТИЧЕСКОГО УВЕЛИЧЕНИЯ ТЕМПЕРАТУРЫ РАБОТЫ
- УПРАВЛЕНИЕ СИГНАЛА ТРЕВОГИ И ДРУГИХ НЕПОЛАДКОВ ПРИ РАБОТЕ
- ОБЪЕМНЫЙ ВСТРОЕННЫЙ НАСОС В ВЕРСИИ S8-S9 EK - EP T.A. DSP
- ОБЪЕМНЫЙ ВСТРОЕННЫЙ НАСОС (ПО ЗАПРОСУ) В ВЕРСИИ S8-S9 EK - EP DSP
- ЭЛЕКТРИЧЕСКИЙ ПОДОГРЕВ ЧАШЕК (ПО ЗАПРОСУ)
- ВОЗМОЖНОСТЬ ОТКЛЮЧЕНИЯ ЭЛЕКТРИЧЕСКОГО ПОДОГРЕВА
- ПОВЫШЕННАЯ ПРОЧНОСТЬ БОЙЛЕРА (ПО ЗАПРОСУ)
- РАССТОЯНИЕ В 16 СМ МЕЖДУ НОСИКОМ ПРОЛИВА ВОДЫ И ЕМКОСТИ ДЛЯ ИСПОЛЬЗОВАНИЯ СТАКАНОВ "TAKE AWAY" В ВЕРСИИ S8-S9 EK - EP T.A. DSP
- ВНИМАТЕЛЬНАЯ РЕШЕТКА ДЛЯ ЧАШЕК ЭСПРЕССО В ВЕРСИИ S8-S9 EK - EP T.A. DSP

ПРЕДЛОЖЕННЫЕ ВАРИАНТЫ:

- MAT** АВТОМАТИЧЕСКАЯ СИСТЕМА ВЗБИВАНИЯ МОЛОКА С ВОЗМОЖНОСТЬЮ РЕГУЛИРОВАНИЯ ТЕМПЕРАТУРЫ
- ITC** КОНТРОЛЬ ИНДИВИДУАЛЬНОЙ ТЕМПЕРАТУРЫ ДЛЯ ГРУПП ПРОЛИВА
- AM** ПРОЛИВ ГОРЯЧЕЙ ВОДЫ ДЛЯ ВРЕМЕННОГО ВЛИВАНИЯ
- GA** ВОЗМОЖНОСТЬ ТЕХНИЧЕСКОГО ВМЕШАТЕЛЬСТВА И УМЯГЧЕНИЯ ПРИ ПОМОЩИ КАРТРЕДЖЕЙ
- КОРПУС ПОД ЗОЛОТО

• S8 • S9 COMPACT EK - EP

- КОФЕ МАШИНА ЭЛЕКТРОННАЯ С 2-Я ГРУППАМИ И ПРОГРАММИРУЕМОЙ НАСТРОЙКОЙ ДОЗИРОВКИ (ВЕРСИЯ EK)
- КОФЕ МАШИНА ПОЛУАВТОМАТ С 2-Я ГРУППАМИ И С ПОСТОЯННОЙ ПОДАЧЕЙ ВОДЫ (ВЕРСИЯ EP)
- ЭЛЕКТРИЧЕСКИЙ ПОДОГРЕВ
- МАНОМЕТР С ДВОЙНОЙ ШКАЛОЙ ДЛЯ ИЗМЕРЕНИЯ ДАВЛЕНИЯ В БОЙЛЕРЕ И В МОТОНАСОСЕ
- 1 ВЫБРОС ГОРЯЧЕЙ ВОДЫ/ 2-А ВЫБРОСА ПАРА
- ЭЛЕКТРИЧЕСКИЙ ПОДОГРЕВ ЧАШЕК (ПО ЗАПРОСУ)
- УПРАВЛЕНИЕ ПРИ СИГНАЛЕ ТРЕВОГИ И ДРУГИХ НЕПОЛАДКАХ ПРИ РАБОТЕ
- ОБЪЕМНЫЙ ВСТРОЕННЫЙ НАСОС
- ПОВЫШЕННАЯ ПРОЧНОСТЬ БОЙЛЕРА (ПО ЗАПРОСУ)

CN • S8 • S9 EK - EP DSP • S8 • S9 EK - EP T.A. DSP

- 自動劑量裝置的電子咖啡機(EK)
- 隨意手動控制分量的半自動的咖啡機(EP)
- 電動鍋爐自動補水
- 電動加熱系統
- 鍋爐和泵壓力控制的雙壓力計
- 1個熱出水口/ 2根蒸汽棒
- 電子鍋爐溫度校準
- LED顯示鍋爐溫度
- 自動調節工作溫度
- 故障警報的控制
- 擁有內置的水泵在S8 • S9 EK裡 -EP T.A. DSP 版本
- 可按要求提供內置水泵在S8 • S9 EK - EP DSP 版本
- 可按要求提供杯子的電暖器
- 可解除電暖氣設備
- 可按要求升級鍋爐加熱電熱元件
- S8 • S9 EK - EP T.A. DSP 版本噴嘴與滴托盤之間的距離為16厘米容易取走杯子
- S8 • S9 EK - EP T.A. DSP 版本espresso咖啡杯的支撐的鐵絲網可移去的



選擇：



- MAT** - 有可調整牛奶溫度的牛奶乳膠的自動系統
- ITC** - 每組擁有獨立的溫度控制
- AM** - 預先注入熱水泡浸的設計
- GA** - 服務時間表控制系統和軟水劑彈藥筒控制金機身

• S8 • S9 COMPACT EK - EP

- 2組自動劑量裝置的電子咖啡機(EK)
- 2組隨意手動控制分量的半自動的咖啡機(EP)
- 電動鍋爐自動補水
- 電動加熱系統
- 鍋爐和泵壓力控制的雙壓力計
- 1個熱出水口/ 2根蒸汽棒
- 故障警報的控制
- 擁有內置的水泵
- 可按要求升級鍋爐加熱電熱元件

S8 DSP • S9 DSP EK - EP			
KESSELKAPAZITÄT - CAPACIDADE DA CALDEIRA ВМЕСТИМОСТЬ БОЙЛЕРА - 鍋爐的容量			
	2	3	4
Litri - Liters Litres - Litros	10	15	20
ANSCHLUßLEISTUNG UND HEIZLEISTUNG VOLTAGEM E CONSUMO ПОДАЧА И ПОГЛОЩЕНИЕ 供給和吸收			
	2	3	4
Volt	400/220-240	400/220-240	400
Hz	50/60	50/60	50/60
W	3300	4300	6300
W+	3800	6300 (400V)	-

S8 DSP • S9 DSP EK - EP T.A.			
KESSELKAPAZITÄT - CAPACIDADE DA CALDEIRA ВМЕСТИМОСТЬ БОЙЛЕРА - 鍋爐的容量			
	2	3	4
Litri - Liters Litres - Litros	10	15	20
ANSCHLUßLEISTUNG UND HEIZLEISTUNG VOLTAGEM E CONSUMO ПОДАЧА И ПОГЛОЩЕНИЕ 供給和吸收			
	2	3	4
Volt	400/220-240	400/220-240	400
Hz	50/60	50/60	50/60
W	3300	4300	6300
W+	3800	6300 (400V)	-

S8 • S9 COMPACT EK - EP		
KESSELKAPAZITÄT - CAPACIDADE DA CALDEIRA ВМЕСТИМОСТЬ БОЙЛЕРА - 鍋爐的容量		
	2	
Litri - Liters Litres - Litros	5	
ANSCHLUßLEISTUNG UND HEIZLEISTUNG VOLTAGEM E CONSUMO ПОДАЧА И ПОГЛОЩЕНИЕ 供給和吸收		
	2	
Volt	220-240	115
Hz	50/60	50/60
W	3000	2300
W+	3800	-

Der Hersteller vorbehält sich das Recht die technischen Daten der in diesem Prospekt beschriebenen Produkte ohne vorherige Benachrichtigung zu verhandern.

O fabricante se reserva no direito de modificar sem pré-aviso as características dos aparelhos descritos neste manual.

СТРОТЕЛЬ МОЖЕТ ИЗМЕНИТЬ ХАРАКТЕРИСТИКИ МАШИНИ ЭТОГО КАТАЛОГА БЕЗ ПРЕДУПРЕЖДЕНИЯ.

製造商保留權利在沒有通知下而變更設備的特性

espresso coffee machines



LA SPAZIALE S.p.A.
Via Eleonora Duse, 8
40033 Casalecchio di Reno (BO) ITALY
Tel. +39 051 6111011
Fax +39 051 6111040
Web Site: www.laspaziale.com
e-mail: info@laspaziale.com



espresso coffee machines

