

AEROEVAPORATORI A SOFFITTO  
*Ceiling unit coolers*



**RIVACOLD**

**Tabella / Table**

(A)	RS1040 RS1040B RS1040BED RS1060 RS1060B RS1060BED
(B)	RS2100 RS2100B RS2100BED RS2130 RS2130B RS2130BED
(C)	RS3180 RS3180B RS3180BED RS3290 RS3290B RS3290BED
(D)	RS4380 RS4380B RS4380BED



(A)



(B)



(C)



(D)

## RS Ceiling unit coolers

### Caratteristiche generali

Gli aeroevaporatori della serie RS sono stati ideati per essere installati all'interno di celle frigorifere per la conservazione di prodotti freschi e congelati. La forma estremamente compatta permette l'installazione anche in celle di dimensioni ridotte. Tutti i modelli sono realizzati con geometria 25x22 e tubo 3/8". Gli RS sono disponibili in due versioni: versione per alta temperatura (passo alette 3,5/7mm differenziato) e versione per media e bassa temperatura, (passo alette 4,5/9mm differenziato). Nei modelli di alta temperatura non è prevista la versione con resistenza montata; per questi modelli la resistenza deve essere richiesta a parte e verrà fornita in dotazione. Per la scelta delle resistenze vedere la tabella di abbinamento qui sotto riportata. I modelli di media e bassa temperatura sono disponibili nella versione senza resistenza (mod. RS...B) e nella versione con resistenza montata e cablata su scatola di derivazione (mod. RS...BED).

### General features

RS range unit coolers have been designed to be installed inside cold rooms suited for fresh and frozen goods storage. Their shape, being extremely compact, make their installation possible also in cold rooms having very small dimensions. All models are made with 25x22 geometry and 3/8" tube. RS range unit coolers are available in two main versions: the one suited for high temperature (differentiated fin spacing 3,5/7mm); the other version suited for medium and low temperature application (differentiated fin spacing 4,5/9mm). In models for high temperature the version with the fitted defrosting heater is not available; for these models the heaters are optional items and they will be supplied not mounted. For the choice of the proper heater, see the table shown here below. The models for medium and low temperature application are available in the version supplied without defrosting heater (mod. RS...B) and with defrosting heater mounted and wired on the unit cooler's terminal box as well (mod. RS...BED).

### Optional - Optional items

- Resistenza di sbrinamento  
*Defrosting heater*
- Batteria verniciata  
*Varnished coil*
- Resistenza per il tubo di scarico  
*Drainage pipe heater*

### Resistenze di sbrinamento Defrosting heater choice

Modello RS RS range	Codice resistenza Heater code
RS1040...	REVS40
RS1060...	REVS60
RS2100...	REVS100
RS2130...	REVS130
RS3180...	REVS180
RS3290...	REVS290
RS4380...	REVS380



Vista interna dei modelli RS per applicazione di alta temperatura

*Internal view of RS models for high temperature applications*

Vista interna dei modelli RS\_B per applicazioni di media e bassa temperatura con sgocciolatoio. Nella versione RS\_BED motoventilatori e resistenza sono cablati su scatola di derivazione.

*Internal view of RS\_B models for medium and low temperature applications with fitted drip tray. The RS\_BED versions are supplied with fan motor and heater wired on a common terminal box.*

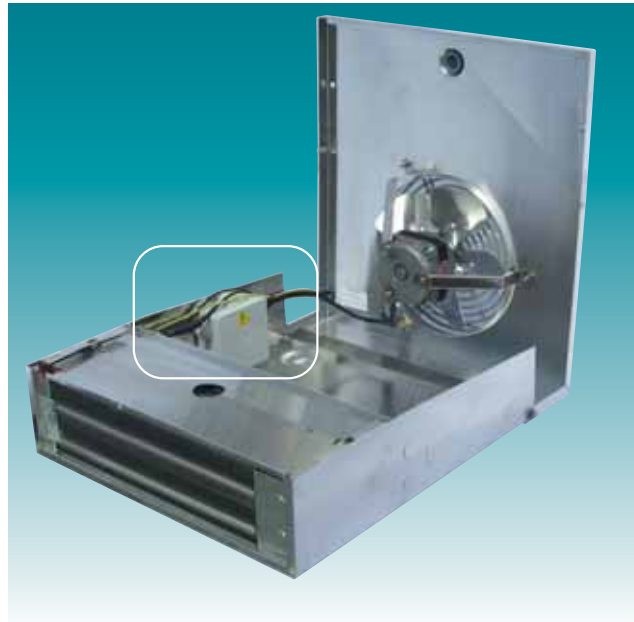

Batteria con passo alette differenziato.

*Coil with differentiated fin spacing.*



Griglia in plastica e staffe di supporto in acciaio.

*Fan guard made of plastic and brackets made of steel.*



## Caratteristiche costruttive

### Manufacturing features

#### Batteria

La batteria è costruita con alette in alluminio e tubo in rame da 3/8".

Essa viene collaudata con azoto ad una pressione di 25 bar.

#### Motoventilatore

Il motoventilatore utilizzato ha le seguenti caratteristiche:

- costruito nel rispetto delle norme EN 60335-1, con protezione termica interna
- flusso aria aspirante
- griglia in plastica
- staffe di supporto in acciaio
- diametro ventola 200 mm, inclinazione 34°
- alimentazione 220-240V/1/50 60Hz
- grado di protezione IP42
- temperatura di funzionamento da -40°C a +40°C
- classe di isolamento B
- esecuzione elettrica conforme alla direttiva 2006/95/CE Bassa Tensione

#### Carenatura

È realizzata in alluminio. Le soluzioni costruttive adottate conferiscono robustezza alla carenatura e garantiscono l'assenza di vibrazioni durante il funzionamento. Le viti, le rondelle e i dadi sono di acciaio inossidabile.

I modelli B e BED sono forniti con gocciolatoio montato.

#### Coil

The coil is made of aluminium fins and 3/8" copper tube.

It is tested with nitrogen at a pressure of 25 bar.

#### Fan motor

The fan motor model in use has the following features:

- manufactured following EN 60335-1 laws, with internal thermal protection
- draw through air flow
- fan guard made of plastic
- brackets made of steel
- fan diameter 200mm, 34° inclination
- power supply 220-240V/1/50-60Hz
- IP42 protection rate
- operating temperature from -40°C to +40°C
- B insulation class
- electrics made in conformity with 2006/95/CE Low Tension directive

#### Housing

The housing is made of aluminium. The manufacturing solutions used give the housing strength and guarantee the absence of vibrations during the functioning.

Screws, washers and nuts are made of stainless steel.

The B and BED models are supplied with fitted drip tray.

## Scelta evaporatore

### Model choice

Per una corretta scelta dell'evaporatore, utilizzare le tabelle "Potenza Frigorifera".

Nelle tabelle sono riportate le rese frigorifere calcolate per una temperatura cella che va da -5°C a +12°C per i modelli con passo alette 3,5/7mm e da -35°C a 0°C per i modelli con passo alette 4,5/9mm. Per tutti i modelli, il  $\Delta T$  (differenza tra la temperatura dell'aria in entrata e la temperatura di evaporazione del refrigerante) va da 5 a 10 e si utilizza come refrigerante gas R404A. Impiegando altri refrigeranti, la capacità va moltiplicata per il fattore correttivo di seguito riportato: R22=0,93 ; R134a=0,91 ; R507/R404A=1.

I parametri per la scelta dell'evaporatore sono: la temperatura della cella, il valore  $\Delta T$  ed il carico termico. Nella colonna corrispondente alla temperatura cella desiderata cercheremo il modello che, in corrispondenza del  $\Delta T$  richiesto, avrà una resa uguale o superiore al carico termico.

For a correct choice of the unit cooler, use the "refrigerating output" tables.

In these tables are quoted the refrigerating capacities calculated for a cold room temperature ranging from -5°C to +12°C for models having their fin spacing of 3,5/7mm and from -35°C to 0°C for models having their fin spacing of 4,5/9mm. For all models the  $\Delta T$  (i.e. difference between the inlet air temperature and the gas evaporating temperature) ranges from 5 to 10 by using R404A gas. In case of a different gas in use, the capacity is to be multiplied by the relevant corrective factor : R22 = 0,93; R134a = 0,91; R507/R404A = 1. The parameters valid for the unit cooler choice are the following ones: the cold room temperature, the  $\Delta T$  value and the heat load. In the column corresponding to the requested cold room temperature we will check the model that, matching the line of the requested  $\Delta T$ , will have a capacity equal or bigger than the heat load.



Manufacturing features

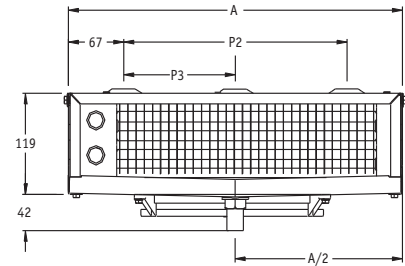
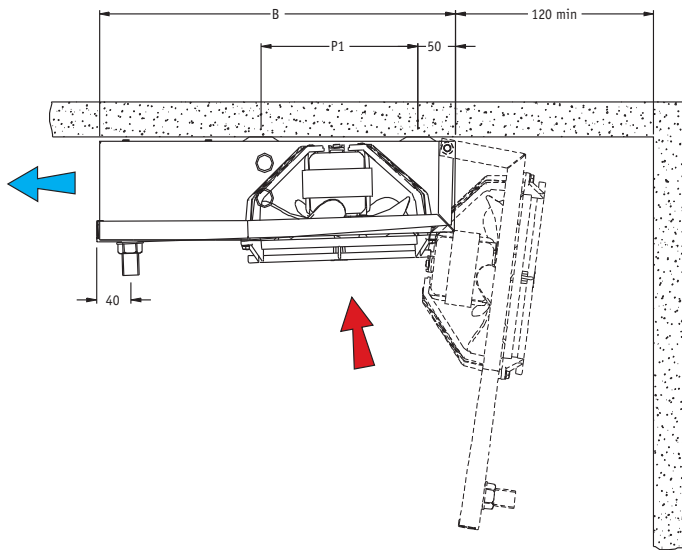

Asole di fissaggio  
Fixing slots

Facilmente accessibile in caso di manutenzione grazie al convogliatore/bacinella che può aprirsi a 90°  
Easily accessible in case of maintenance thanks to the conveyor/tray that can be opened up to 90°

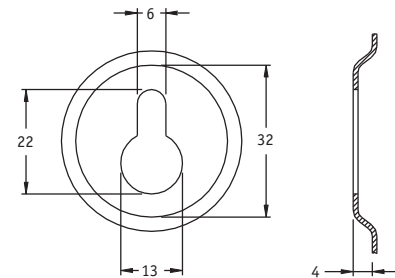

Serie RS / RS Range

Modello Model	RS	1040	1060	2100	2130	3180	3290	4380
		1040B	1060B	2100B	2130B	3180B	3290B	4380B
		1040BED	1060BED	2100BED	2130BED	3180BED	3290BED	4380BED
Dimensioni Dimensions (mm)	P1	175	190	190	190	190	190	190
	P2	270	270	470	470	970	970	1245
	P3	-	-	-	-	-	-	622,5
	A	404	404	604	604	1104	1104	1379
	B	360	433	433	433	433	433	433
Attacchi Connections	Ø ingresso Ø inlet	9,52 mm	9,52 mm	9,52 mm	9,52 mm	1/2" SAE	1/2" SAE	1/2" SAE
	Ø uscita Ø outlet	9,52 mm	9,52 mm	9,52 mm	9,52 mm	16mm	16 mm	16 mm
	Ø scarico Ø drain	1/2"Gas(20mm)	1/2"Gas(20mm)	1/2"Gas(20mm)	1/2"Gas(20mm)	1/2"Gas(20mm)	1/2"Gas(20mm)	1/2"Gas(20mm)



## Caratteristiche tecniche

### Technical features

Serie RS / RS Range			3,5 - 7					Passo alette / Fin spacing
Modello Model		1040	1060	2100	2130	3180	3290	4380
Capacità $\Delta T 10$ T. cella +2°C Capacity $\Delta T 10$ Room T. +2°C	W	406	595	741	1010	1390	1910	2360
Portata d'aria Air flow	m <sup>3</sup> /h	223	195	382	337	705	595	784
Freccia d'aria Air throw	m	3,0	2,5	3,0	2,5	3,0	2,5	2,5
Superficie totale Total surface	m <sup>2</sup>	1,48	2,22	2,42	3,63	4,77	7,16	9,1
Peso netto Net weight	kg	4,0	4,6	6,7	7,3	10,5	11,5	16,5

Serie RS...B / RS...B Range			4,5 - 9					Passo alette / Fin spacing	
Modello Model		1040B	1060B	2100B	2130B	3180B	3290B	4380B	
		1040BED	1060BED	2100BED	2130BED	3180BED	3290BED	4380BED	
Capacità $\Delta T 10$ T. cella -20°C Capacity $\Delta T 10$ Room T. -20°C	W	346	474	579	707	1110	1380	1570	
Portata d'aria Air flow	m <sup>3</sup> /h	243	213	426	382	773	684	866	
Freccia d'aria Air throw	m	3,0	2,5	3,0	2,5	3,0	2,5	2,5	
Superficie totale Total surface	m <sup>2</sup>	1,18	1,78	1,94	2,9	3,82	5,72	7,28	
Peso netto Net weight	vers. standard standard vers.	kg	3,9	4,5	6,6	7,2	10,4	11,4	16,3
	vers. ED ED vers.	kg	4,2	4,8	7,0	7,6	11,0	12,0	17,1

Serie RS-RS...B / RS-RS...B Range								
Modello Model		1040	1060	2100	2130	3180	3290	4380
		1040BED	1060BED	2100BED	2130BED	3180BED	3290BED	4380BED
Volume circuito evaporatore Evaporator circuit volume	dm <sup>3</sup>	0,38	0,58	0,60	0,91	1,15	1,73	2,19
Motoventilatori Fan motors	n x Ømm	1x200	1x200	2x200	2x200	3x200	3x200	4x200
Assorbimento motori (*) Motor power consumption	A	0,25	0,25	0,50	0,50	0,75	0,75	1
	W	43	43	86	86	129	129	172
Sbrinamento elettrico (*) Electrical defrost	W	400	400	600	650	1000	1000	1300

(\*) Alimentazione elettrica 220V-1-50Hz / Power supply 220V-1-50Hz

## Refrigerating output

## RS1040

3,5 - 7 Passo alette / Fin spacing

Tc			-5°C <sup>(1)</sup>	0°C <sup>(1)</sup>	2°C	4°C	6°C	8°C	10°C	12°C	15°C
ΔT 10	UR/RH 76%	Watt	386	404	406	408	412	416	420	425	433
ΔT 9	UR/RH 79%	Watt	336	352	354	356	359	362	365	371	380
ΔT 8	UR/RH 82%	Watt	286	300	302	304	306	308	310	315	323
ΔT 7	UR/RH 85%	Watt	235	246	247	248	249	250	254	258	264
ΔT 6	UR/RH 89%	Watt	185	194	195	196	197	199	202	206	212
ΔT 5	UR/RH 93%	Watt	131	137	138	139	140	143	145	148	153

## RS1040B RS1040BED

4,5 - 9 Passo alette / Fin spacing

Tc			-35°C <sup>(2)</sup>	-30°C <sup>(2)</sup>	-25°C	-20°C	-15°C	-10°C	-5°C	0°C
ΔT 10	UR/RH 76%	Watt	311	326	337	346	351	357	371	389
ΔT 9	UR/RH 79%	Watt	275	286	294	302	305	311	323	339
ΔT 8	UR/RH 82%	Watt	237	244	250	253	256	264	275	289
ΔT 7	UR/RH 85%	Watt	196	201	206	207	210	216	226	237
ΔT 6	UR/RH 89%	Watt	154	157	160	162	164	170	177	187
ΔT 5	UR/RH 93%	Watt	109	111	112	113	116	120	126	134

## RS1060

3,5 - 7 Passo alette / Fin spacing

Tc			-5°C <sup>(1)</sup>	0°C <sup>(1)</sup>	2°C	4°C	6°C	8°C	10°C	12°C	15°C
ΔT 10	UR/RH 76%	Watt	557	589	595	600	605	610	618	635	661
ΔT 9	UR/RH 79%	Watt	487	515	520	523	527	536	545	556	573
ΔT 8	UR/RH 82%	Watt	422	446	449	451	453	458	472	482	497
ΔT 7	UR/RH 85%	Watt	354	376	379	382	385	389	397	405	417
ΔT 6	UR/RH 89%	Watt	288	307	310	313	316	320	328	335	346
ΔT 5	UR/RH 93%	Watt	217	232	234	236	239	244	250	257	268

## RS1060B RS1060BED

4,5 - 9 Passo alette / Fin spacing

Tc			-35°C <sup>(2)</sup>	-30°C <sup>(2)</sup>	-25°C	-20°C	-15°C	-10°C	-5°C	0°C
ΔT 10	UR/RH 76%	Watt	385	420	449	474	490	506	532	563
ΔT 9	UR/RH 79%	Watt	351	378	401	416	429	448	470	499
ΔT 8	UR/RH 82%	Watt	312	333	351	362	372	388	407	432
ΔT 7	UR/RH 85%	Watt	269	285	297	305	313	326	342	364
ΔT 6	UR/RH 89%	Watt	222	233	239	244	253	264	278	297
ΔT 5	UR/RH 93%	Watt	170	176	179	183	189	189	209	224

Tc = temperatura cella / cold room temperature

(1) Per modelli passo alette 3,5 - 7 mm, si consiglia un utilizzo ad una Tc ≥ +2°C - For 3,5 - 7 mm fin spacing models we recommend to use the application Tc ≥ +2°C

(2) Per modelli passo alette 4,5 - 9 mm, si consiglia un utilizzo ad una Tc ≥ -25°C - For 4,5 - 9 mm fin spacing models we recommend to use the application Tc ≥ -25°C



**R404A****Potenza frigorifera***Refrigerating output***RS2100**

3,5 - 7 Passo alette / Fin spacing

Tc			-5°C <sup>(1)</sup>	0°C <sup>(1)</sup>	2°C	4°C	6°C	8°C	10°C	12°C	15°C
ΔT 10	UR/RH 76%	Watt	693	733	741	748	754	760	770	792	825
ΔT 9	UR/RH 79%	Watt	614	651	656	660	666	677	688	701	721
ΔT 8	UR/RH 82%	Watt	533	564	568	570	573	579	596	608	626
ΔT 7	UR/RH 85%	Watt	449	476	480	484	488	492	502	511	525
ΔT 6	UR/RH 89%	Watt	365	388	392	396	400	405	413	423	438
ΔT 5	UR/RH 93%	Watt	271	289	291	294	297	304	311	319	331

**RS2100B RS2100BED**

4,5 - 9 Passo alette / Fin spacing

Tc			-35°C <sup>(2)</sup>	-30°C <sup>(2)</sup>	-25°C	-20°C	-15°C	-10°C	-5°C	0°C
ΔT 10	UR/RH 76%	Watt	459	509	543	579	610	629	663	703
ΔT 9	UR/RH 79%	Watt	420	455	488	516	542	558	587	623
ΔT 8	UR/RH 82%	Watt	376	404	429	450	471	484	509	541
ΔT 7	UR/RH 85%	Watt	327	346	365	382	390	408	429	456
ΔT 6	UR/RH 89%	Watt	269	285	298	310	317	331	348	372
ΔT 5	UR/RH 93%	Watt	208	217	225	233	237	249	263	281

**RS2130**

3,5 - 7 Passo alette / Fin spacing

Tc			-5°C <sup>(1)</sup>	0°C <sup>(1)</sup>	2°C	4°C	6°C	8°C	10°C	12°C	15°C
ΔT 10	UR/RH 76%	Watt	916	989	1010	1020	1040	1060	1080	1110	1110
ΔT 9	UR/RH 79%	Watt	829	893	908	921	934	947	978	1000	1000
ΔT 8	UR/RH 82%	Watt	734	791	802	811	821	836	864	886	886
ΔT 7	UR/RH 85%	Watt	626	673	679	685	691	714	733	751	751
ΔT 6	UR/RH 89%	Watt	525	567	571	574	583	605	622	639	639
ΔT 5	UR/RH 93%	Watt	416	450	456	463	470	484	498	513	513

**RS2130B RS2130BED**

4,5 - 9 Passo alette / Fin spacing

Tc			-35°C <sup>(2)</sup>	-30°C <sup>(2)</sup>	-25°C	-20°C	-15°C	-10°C	-5°C	0°C
ΔT 10	UR/RH 76%	Watt	478	559	635	707	765	826	890	960
ΔT 9	UR/RH 79%	Watt	450	522	586	647	695	748	803	866
ΔT 8	UR/RH 82%	Watt	417	479	531	581	620	664	711	766
ΔT 7	UR/RH 85%	Watt	378	426	470	503	538	574	614	660
ΔT 6	UR/RH 89%	Watt	332	367	401	425	452	481	514	555
ΔT 5	UR/RH 93%	Watt	273	299	318	337	357	379	406	440

Tc = temperatura cella / cold room temperature

(1) Per modelli passo alette 3,5 - 7 mm, si consiglia un utilizzo ad una Tc ≥ +2°C - For 3,5 - 7 mm fin spacing models we recommend to use the application Tc ≥ +2°C

(2) Per modelli passo alette 4,5 - 9 mm, si consiglia un utilizzo ad una Tc ≥ -25°C - For 4,5 - 9 mm fin spacing models we recommend to use the application Tc ≥ -25°C

## Refrigerating output

## RS3180

3,5 - 7 Passo alette / Fin spacing

Tc			-5°C <sup>(1)</sup>	0°C <sup>(1)</sup>	2°C	4°C	6°C	8°C	10°C	12°C	15°C
ΔT 10	UR/RH 76%	Watt	1300	1380	1390	1400	1410	1420	1440	1480	1540
ΔT 9	UR/RH 79%	Watt	1150	1220	1230	1240	1250	1270	1290	1310	1340
ΔT 8	UR/RH 82%	Watt	1000	1060	1072	1084	1096	1108	1120	1140	1170
ΔT 7	UR/RH 85%	Watt	841	890	897	905	913	921	940	958	985
ΔT 6	UR/RH 89%	Watt	684	727	735	743	751	759	775	792	818
ΔT 5	UR/RH 93%	Watt	515	551	556	561	566	580	594	609	632

## RS3180B RS3180BED

4,5 - 9 Passo alette / Fin spacing

Tc			-35°C <sup>(2)</sup>	-30°C <sup>(2)</sup>	-25°C	-20°C	-15°C	-10°C	-5°C	0°C
ΔT 10	UR/RH 76%	Watt	920	991	1060	1110	1170	1200	1260	1330
ΔT 9	UR/RH 79%	Watt	828	892	945	990	1030	1060	1110	1180
ΔT 8	UR/RH 82%	Watt	735	786	826	861	882	919	964	1020
ΔT 7	UR/RH 85%	Watt	634	671	701	726	742	773	811	861
ΔT 6	UR/RH 89%	Watt	524	549	569	588	600	626	659	702
ΔT 5	UR/RH 93%	Watt	400	414	427	434	449	470	497	532

## RS3290

3,5 - 7 Passo alette / Fin spacing

Tc			-5°C <sup>(1)</sup>	0°C <sup>(1)</sup>	2°C	4°C	6°C	8°C	10°C	12°C	15°C
ΔT 10	UR/RH 76%	Watt	1750	1880	1910	1940	1960	1990	2030	2090	2180
ΔT 9	UR/RH 79%	Watt	1570	1690	1710	1740	1760	1780	1840	1880	1940
ΔT 8	UR/RH 82%	Watt	1390	1490	1510	1520	1540	1570	1620	1660	1720
ΔT 7	UR/RH 85%	Watt	1200	1280	1300	1310	1330	1360	1390	1430	1490
ΔT 6	UR/RH 89%	Watt	989	1060	1070	1080	1090	1130	1160	1200	1260
ΔT 5	UR/RH 93%	Watt	780	842	854	867	880	906	932	959	1000

## RS3290B RS3290BED

4,5 - 9 Passo alette / Fin spacing

Tc			-35°C <sup>(2)</sup>	-30°C <sup>(2)</sup>	-25°C	-20°C	-15°C	-10°C	-5°C	0°C
ΔT 10	UR/RH 76%	Watt	986	1130	1270	1380	1470	1580	1690	1810
ΔT 9	UR/RH 79%	Watt	922	1050	1160	1260	1330	1420	1520	1630
ΔT 8	UR/RH 82%	Watt	848	954	1040	1120	1180	1250	1340	1430
ΔT 7	UR/RH 85%	Watt	760	838	910	963	1020	1080	1150	1230
ΔT 6	UR/RH 89%	Watt	660	718	770	807	852	901	961	1030
ΔT 5	UR/RH 93%	Watt	534	577	605	636	669	708	755	817

Tc = temperatura cella / cold room temperature

- (1) Per modelli passo alette 3,5 - 7 mm, si consiglia un utilizzo ad una Tc ≥ +2°C - For 3,5 - 7 mm fin spacing models we recommend to use the application Tc ≥ +2°C  
 (2) Per modelli passo alette 4,5 - 9 mm, si consiglia un utilizzo ad una Tc ≥ -25°C - For 4,5 - 9 mm fin spacing models we recommend to use the application Tc ≥ -25°C

**R404A****Potenza frigorifera***Refrigerating output***RIVACOLD****RS4380**

3,5 - 7 Passo alette / Fin spacing

Tc			-5°C <sup>(1)</sup>	0°C <sup>(1)</sup>	2°C	4°C	6°C	8°C	10°C	12°C	15°C
ΔT 10	UR/RH 76%	Watt	2120	2300	2360	2400	2450	2490	2560	2640	2760
ΔT 9	UR/RH 79%	Watt	1930	2100	2140	2180	2220	2260	2330	2400	2505
ΔT 8	UR/RH 82%	Watt	1730	1870	1910	1930	1970	2010	2080	2140	2230
ΔT 7	UR/RH 85%	Watt	1510	1640	1660	1680	1700	1760	1810	1860	1935
ΔT 6	UR/RH 89%	Watt	1290	1400	1410	1430	1450	1510	1550	1600	1675
ΔT 5	UR/RH 93%	Watt	1040	1130	1140	1150	1190	1230	1270	1310	1370

**RS4380B RS4380BED**

4,5 - 9 Passo alette / Fin spacing

Tc			-35°C <sup>(2)</sup>	-30°C <sup>(2)</sup>	-25°C	-20°C	-15°C	-10°C	-5°C	0°C
ΔT 10	UR/RH 76%	Watt	1000	1200	1390	1570	1740	1890	2050	2240
ΔT 9	UR/RH 79%	Watt	995	1130	1290	1450	1600	1720	1870	2030
ΔT 8	UR/RH 82%	Watt	892	1040	1190	1320	1430	1540	1670	1810
ΔT 7	UR/RH 85%	Watt	820	947	1060	1170	1250	1350	1460	1580
ΔT 6	UR/RH 89%	Watt	731	831	921	993	1070	1150	1240	1350
ΔT 5	UR/RH 93%	Watt	621	693	759	808	853	915	996	1090

Tc = temperatura cella / cold room temperature

- (1) Per modelli passo alette 3,5 - 7 mm, si consiglia un utilizzo ad una Tc ≥ +2°C - For 3,5 - 7 mm fin spacing models we recommend to use the application Tc ≥ +2°C  
 (2) Per modelli passo alette 4,5 - 9 mm, si consiglia un utilizzo ad una Tc ≥ -25°C - For 4,5 - 9 mm fin spacing models we recommend to use the application Tc ≥ -25°C

**Dimensioni imballo***Package dimensions*

Codice Code	Dimensioni imballo evaporatore Evaporator package dimensions			
	A mm	B mm	H mm	Peso Weight kg
RS1 . . . . .	432	455	155	0,8
RS2 . . . . .	632	455	155	1,0
RS3 . . . . .	1135	455	155	1,6
RS4 . . . . .	1410	455	155	2,5

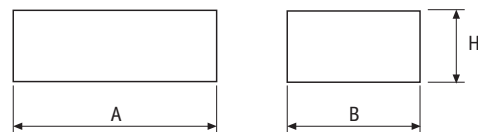

**Tabella / Table**

(A)	RSV1200405 RSV1200405ED RSV1200605 RSV1200605ED
(B)	RSV2200405 RSV2200405ED RSV2200605 RSV2200605ED



## Aeroevaporatori a soffitto RSV

### RSV Ceiling unit coolers

#### Caratteristiche generali

Gli aeroevaporatori della serie RSV sono stati ideati per essere installati all'interno di celle frigorifere per la conservazione di prodotti freschi e congelati. La forma estremamente compatta permette l'installazione in celle di dimensioni ridotte. Grazie ai motoventilatori ad alta velocità, cablati su scatola di derivazione, ed al posizionamento della batteria, che offre un migliore scambio termico, si ottengono rese maggiori a parità di ingombro.

Gli RSV sono realizzati con geometria 25 x 22, tubo da 3/8" e passo alette da 5 mm; la serie ED, con resistenza montata e cablata su scatola di derivazione è particolarmente adatta per essere utilizzata a basse temperature.

#### General features

RSV unit coolers have been designed to be installed inside cold rooms suited for fresh and frozen goods storage. Their shape, being extremely compact, make their installation suitable also in cold rooms of small dimensions. Thanks to their high speed fan motors, wired on terminal box, and to the evaporator coil placing that give them a higher thermal change, give a result of higher capacities compared to the same overall dimensions.

RSV models are made with 25 x 22 geometry, 3/8" tube and 5 mm fin spacing. The ED version, supplied with fitted defrosting heater and wired on a terminal box is particularly suitable for being used in low temperature applications.

#### Optional - *Optional items*

- Batteria verniciata  
*Varnished coil*
- Resistenza per il tubo di scarico  
*Drainage pipe heater*



Dettaglio collegamento frigorifero

Refrigeration connection detail

Caratteristiche costruttive

Manufacturing features



Tutti i modelli hanno di serie il gocciolatoio montato che va a coprire completamente la batteria fino alle curvette.

*All models are equipped with fitted drip tray that covers completely the coil up to the bends.*

Mod. RSV con motoventilatore cablato su scatola di derivazione.

*RSV model with fan motor wired on the unit cooler's terminal box.*

Mod. RSV....ED per bassa temp. con resistenza montata e cablata su scatola di derivazione.  
*RSV....ED model for low temp. with defrosting heater mounted and wired on the unit cooler's terminal box.*

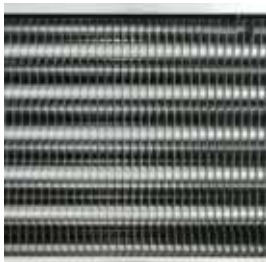

Batteria con passo alette uniforme.  
*Coil with uniformed fin spacing.*



Griglia e staffe di supporto in plastica.  
*Fan guard and brackets made of plastic.*



## Caratteristiche costruttive

### Manufacturing features

#### Batteria

La batteria è costruita con alette in alluminio e tubo in rame da 3/8".  
Essa viene collaudata con azoto ad una pressione di 25 bar.

#### Motoventilatore

Il motoventilatore utilizzato ha le seguenti caratteristiche:

- costruito nel rispetto delle norme EN 60335-1, con protezione termica interna
- flusso aria aspirante
- griglia e staffe di supporto in plastica
- diametro ventola 200 mm, inclinazione 34°
- alimentazione 230-240V/1/50-60Hz
- grado di protezione IP42
- temperatura di funzionamento da -40°C a +40°C
- classe di isolamento B
- esecuzione elettrica conforme alla direttiva 2006/95/CE Bassa Tensione

#### Carenatura

E' realizzata in alluminio. Le soluzioni costruttive adottate conferiscono robustezza alla carenatura e garantiscono l'assenza di vibrazioni durante il funzionamento. Le viti, le rondelle e i dadi sono di acciaio inossidabile.  
Tutti i modelli sono forniti di gocciolatoio

#### Coil

The coil is made of aluminium fins and 3/8" copper tube.  
It is tested with nitrogen at a pressure of 25 bar.

#### Fan motor

The fan motor model in use has the following features:

- manufactured following EN 60335-1 laws, with internal thermal protection
- draw through air flow
- fan guard and brackets made of plastic
- fan diameter 200mm, 34° inclination
- power supply 230-240V/1/50-60Hz
- IP42 protection rate
- operating temperature from -40°C to +40°C
- B insulation class
- electrics made in conformity with 2006/95/CE Low Tension directive

#### Housing

The housing is made of aluminium. The manufacturing solutions used give the housing strength and guarantee the absence of vibrations during the functioning.  
Screws, washers and nuts are made of stainless steel.  
All models are supplied with fitted drip tray

## Scelta evaporatore

### Model choice

Per una corretta scelta dell'evaporatore, utilizzare le tabelle "Potenza Frigorifera".  
Nelle tabelle sono riportate le rese frigorifere calcolate per una temperatura cella che va da -35°C a +12°C. il  $\Delta T$  (differenza tra la temperatura dell'aria in entrata e la temperatura di evaporazione del refrigerante) va da 5 a 10 e si utilizza come refrigerante gas R404A. Impiegando altri refrigeranti, la capacità va moltiplicata per il fattore correttivo di seguito riportato: R22=0,93; R134a=0,91 ; R507/R404A=1.  
I parametri per la scelta dell'evaporatore sono: la temperatura della cella, il valore  $\Delta T$  ed il carico termico. Nella colonna corrispondente alla temperatura cella desiderata cercheremo il modello che, in corrispondenza del  $\Delta T$  richiesto, avrà una resa uguale o superiore al carico termico.

For a correct choice of the unit cooler, use the "refrigerating output" tables.  
In these tables are quoted the refrigerating capacities calculated for a cold room temperature ranging from -35°C to +12°C. The  $\Delta T$  (i.e. difference between the inlet air temperature and the gas evaporating temperature) ranges from 5 to 10 by using R404A gas. In case of a different gas in use, the capacity is to be multiplied by the relevant corrective factor : R22 = 0,93; R134a = 0,91; R507/R404A = 1.  
The parameters valid for the unit cooler choice are the following ones: the cold room temperature, the  $\Delta T$  value and the heat load. In the column corresponding to the requested cold room temperature we will check the model that, matching the line of the requested  $\Delta T$ , will have a capacity equal or bigger than the heat load.



Manufacturing features

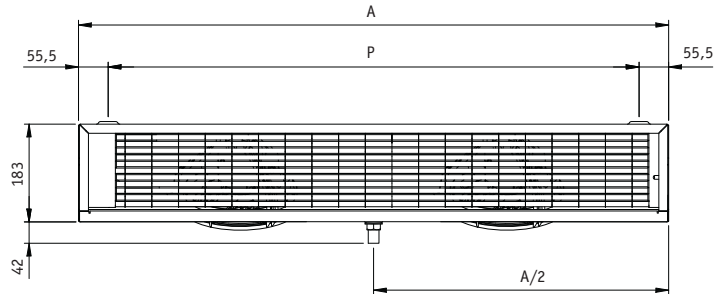
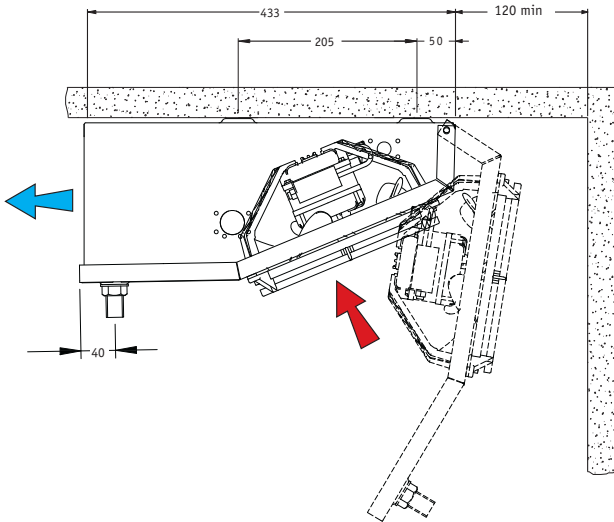

Asole di fissaggio  
Fixing slots

Facilmente accessibile in caso di manutenzione grazie al convogliatore/bacinella che può aprirsi a 90°  
Easily accessible in case of maintenance thanks to the conveyor/tray that can be opened up to 90°

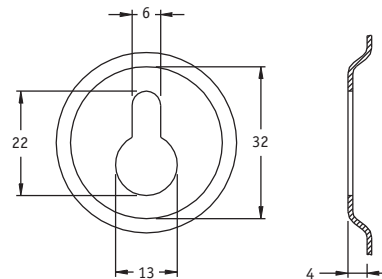

Serie RSV / RSV Range

Modello Model	RSV	1200405 1200405 ED	1200605 1200605 ED	2200405 2200405 ED	2200605 2200605 ED
Dimensioni Dimensions (mm)	p	545	545	995	995
	A	656	656	1106	1106
Attacchi Connections	ø ingresso ø inlet	12 mm	12 mm	12 mm	12 mm
	ø uscita ø outlet	14 mm	14 mm	14 mm	16 mm
	ø scarico ø drain	1/2"Gas(20mm)	1/2"Gas(20mm)	1/2"Gas(20mm)	1/2"Gas(20mm)



## Technical features

### Serie RSV....ED / RSV....ED Range

5 Passo alette / Fin spacing

Modello Model		1200405 1200405 ED	1200605 1200605 ED	2200405 2200405 ED	2200605 2200605 ED
Capacità $\Delta T$ 10 T. cella +2°C Capacity $\Delta T$ 10 Room T. +2°C	W	1080	1410	2030	2650
Portata d'aria Air flow	m <sup>3</sup> /h	630	600	1230	1170
Freccia d'aria Air throw	m	-	-	-	-
Superficie totale Total surface	m <sup>2</sup>	2,83	4,25	5,15	7,73
Peso netto Net weight	kg	6,1	7,2	10,7	12,5
Peso netto ED Net weight ED	kg	7,2	8,3	11,9	13,7

### Serie RSV....ED / RSV....ED Range

Modello Model		1200405 1200405 ED	1200605 1200605 ED	2200405 2200405 ED	2200605 2200605 ED
Volume circuito evaporatore Evaporator circuit volume	dm <sup>3</sup>	0,996	1,45	1,71	2,56
Motoventilatori Fan motors	n x Ømm	1x200	1x200	2x200	2x200
Assorbimento motori (*) Motor power consumption	A	0,27	0,27	0,54	0,54
	W	62	62	124	124
Sbrinamento elettrico (*) Electrical defrost	W	650	650	1200	1200

(\*) Alimentazione elettrica 230V-1-50Hz / Power supply 230V-1-50Hz

### Dimensioni imballo

#### Package dimensions

Codice Code	Dimensioni imballo evaporatore Evaporator package dimensions			
	A mm	B mm	H mm	Peso Weight kg
RSV1200405	700	440	250	2,4
RSV1200605	700	440	250	2,4
RSV2200405	1150	440	250	3,3
RSV2200605	1150	440	250	3,3

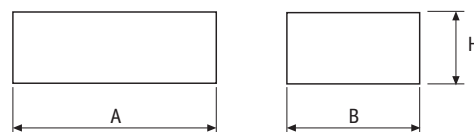

## RSV1200405 RSV1200405 ED

5 Passo alette / Fin spacing

Tc		-35°C <sup>(1)</sup>	-30°C <sup>(1)</sup>	-25°C	-20°C	-15°C	-10°C	-5°C	0°C	2°C	4°C	6°C	8°C	10°C	12°C	15°C
ΔT 10	UR/RH 76% Watt	770	820	860	900	930	970	1010	1070	1080	1090	1100	1110	1130	1160	1210
ΔT 9	UR/RH 79% Watt	690	740	770	800	830	860	900	950	960	970	980	980	1010	1040	1090
ΔT 8	UR/RH 82% Watt	620	650	680	690	720	750	790	830	840	840	850	860	890	910	940
ΔT 7	UR/RH 85% Watt	530	560	580	590	610	640	670	710	710	720	720	740	760	780	800
ΔT 6	UR/RH 89% Watt	450	460	480	490	510	530	560	600	600	600	600	630	650	660	690
ΔT 5	UR/RH 93% Watt	350	360	380	390	400	420	450	480	480	480	500	510	530	550	570

## RSV 1200605 RSV 1200605 ED

5 Passo alette / Fin spacing

Tc		-35°C <sup>(1)</sup>	-30°C <sup>(1)</sup>	-25°C	-20°C	-15°C	-10°C	-5°C	0°C	2°C	4°C	6°C	8°C	10°C	12°C	15°C
ΔT 10	UR/RH 76% Watt	830	930	1020	1090	1160	1220	1290	1380	1410	1430	1440	1460	1490	1540	1620
ΔT 9	UR/RH 79% Watt	770	860	930	990	1040	1100	1160	1250	1270	1280	1290	1310	1350	1390	1450
ΔT 8	UR/RH 82% Watt	700	770	830	880	920	970	1030	1100	1120	1130	1140	1160	1200	1230	1280
ΔT 7	UR/RH 85% Watt	630	680	720	760	800	840	880	950	960	970	970	1010	1030	1060	1110
ΔT 6	UR/RH 89% Watt	540	580	610	640	670	710	750	810	820	820	830	870	890	920	970
ΔT 5	UR/RH 93% Watt	450	480	500	520	540	570	610	670	670	670	700	720	750	780	820

## RSV2200405 RSV 2200405 ED

5 Passo alette / Fin spacing

Tc		-35°C <sup>(1)</sup>	-30°C <sup>(1)</sup>	-25°C	-20°C	-15°C	-10°C	-5°C	0°C	2°C	4°C	6°C	8°C	10°C	12°C	15°C
ΔT 10	UR/RH 76% Watt	1000	1170	1320	1470	1600	1710	1840	1990	2030	2060	2090	2130	2180	2250	2360
ΔT 9	UR/RH 79% Watt	940	1090	1220	1340	1460	1560	1670	1800	1830	1860	1890	1910	1980	2030	2110
ΔT 8	UR/RH 82% Watt	870	1000	1110	1210	1300	1390	1490	1600	1630	1650	1670	1700	1760	1810	1890
ΔT 7	UR/RH 85% Watt	790	900	990	1070	1130	1210	1290	1400	1410	1430	1440	1490	1540	1580	1640
ΔT 6	UR/RH 89% Watt	700	780	850	910	970	1030	1100	1200	1210	1220	1240	1290	1330	1370	1430
ΔT 5	UR/RH 93% Watt	590	650	700	750	790	840	910	990	1000	1000	1040	1080	1120	1160	1220

## RSV2200605 RSV2200605 ED

5 Passo alette / Fin spacing

Tc		-35°C <sup>(1)</sup>	-30°C <sup>(1)</sup>	-25°C	-20°C	-15°C	-10°C	-5°C	0°C	2°C	4°C	6°C	8°C	10°C	12°C	15°C
ΔT 10	UR/RH 76% Watt	1400	1600	1790	1950	2110	2260	2410	2600	2650	2690	2730	2770	2830	2930	3080
ΔT 9	UR/RH 79% Watt	1310	1480	1640	1790	1920	2050	2190	2350	2390	2430	2460	2500	2580	2650	2760
ΔT 8	UR/RH 82% Watt	1200	1350	1490	1600	1710	1810	1930	2080	2110	2130	2160	2200	2300	2360	2450
ΔT 7	UR/RH 85% Watt	1090	1210	1310	1410	1490	1580	1680	1810	1830	1850	1870	1940	1990	2050	2140
ΔT 6	UR/RH 89% Watt	950	1050	1130	1200	1260	1340	1430	1550	1570	1580	1610	1680	1730	1790	1880
ΔT 5	UR/RH 93% Watt	800	880	930	980	1030	1100	1180	1290	1300	1300	1360	1410	1460	1510	1590

Tc = temperatura cella / cold room temperature

(1) Per tutti i modelli, si consiglia un utilizzo ad una Tc ≥ -25°C - For all models we recommend to use the application Tc ≥ -25°C

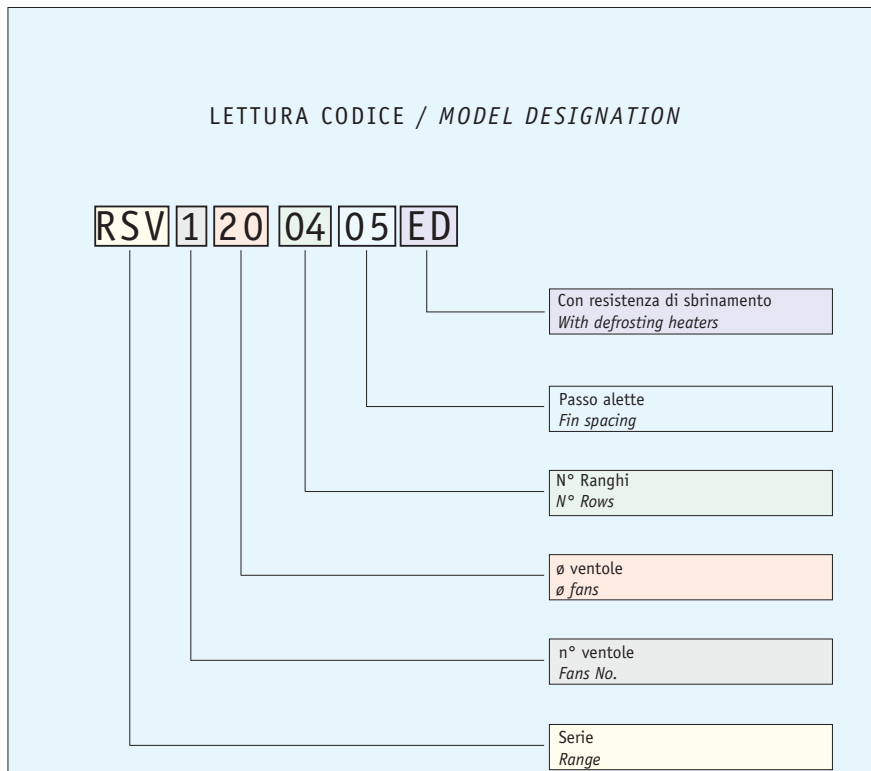
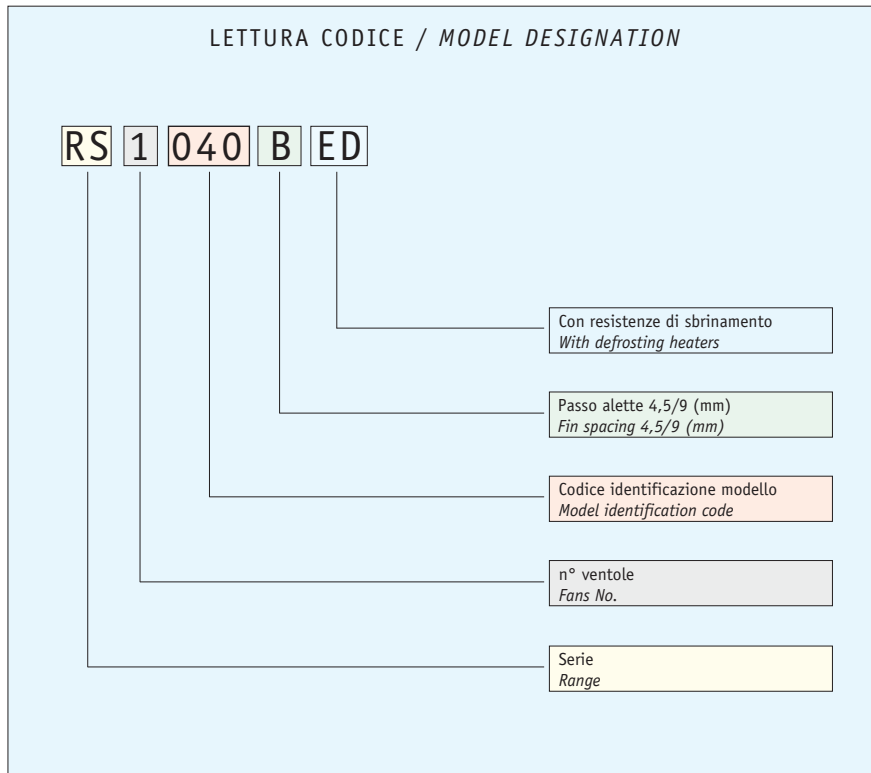

Per ulteriori informazioni, contattare il nostro ufficio tecnico / For further information, please contact our technical dept

Descrizione, dati tecnici e illustrazioni sono indicativi e non vincolanti. La Rivacold si riserva il diritto di modificare per intero o in parte le specifiche descritte nella presente documentazione senza preavviso e a beneficio della continuità produttiva, di utilizzare produttori alternativi di componenti previsti nel progetto

Descriptions, technical data and pictures are to be considered as a guide and not binding. Rivacold reserves the right to change in whole or part, the specification detailed in this documentation without prior notice and, when necessary to achieve continuous production, to use alternative manufactures of components for the design accomplishment

# Aeroevaporatori Rivacold

Rivacold unit coolers

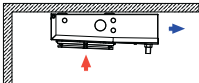
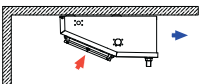
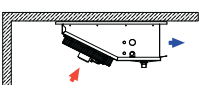
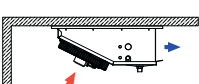
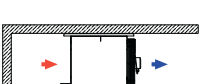
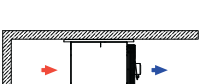
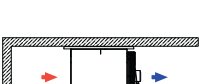
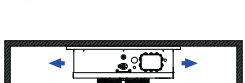
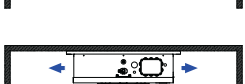
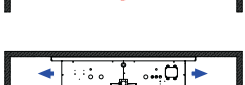
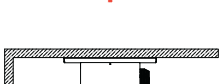
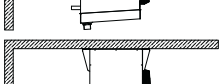
Serie Range	Potenza / Capacity								Ventole Fans	
	1000W	2000W	4000W	8000W	16000W	32000W	64000W	128000W		
RS	109 - 2640 w									1 - 4
RSV	350 - 2930 w									1 - 2
RSI 250	440 - 5380 w									1 - 4
RSI 350	1580 - 11600 w									2 - 4
RC	602 - 7380 w									1 - 4
RCS	410 - 8120 w									1 - 4
RCMR	1840 - 22400 w									1 - 4
RDF 250	400 - 5710 w									1 - 4
RDF 350	1630 - 17400 w									2 - 5
RDFR 500	3260 - 82050 w									1 - 4
RCBR 500	2950 - 59800 w									1 - 4
RCBR 630	3180 - 71200 w									1 - 4

**RIVACOLD** s.r.l.

Costruzione Gruppi Frigoriferi e Accessori

Via Sicilia, 7 - 61020 Montecchio PU - Italy

Tel. +39.0721.919911 - Fax +39.0721.490015

[www.rivacold.com](http://www.rivacold.com) / [info@rivacold.com](mailto:info@rivacold.com)



A Member of **RIVACOLD GROUP** 