

+

Not included / Non incluso / Non Inclus / Nie zawarty / No incluido / Nao incluido

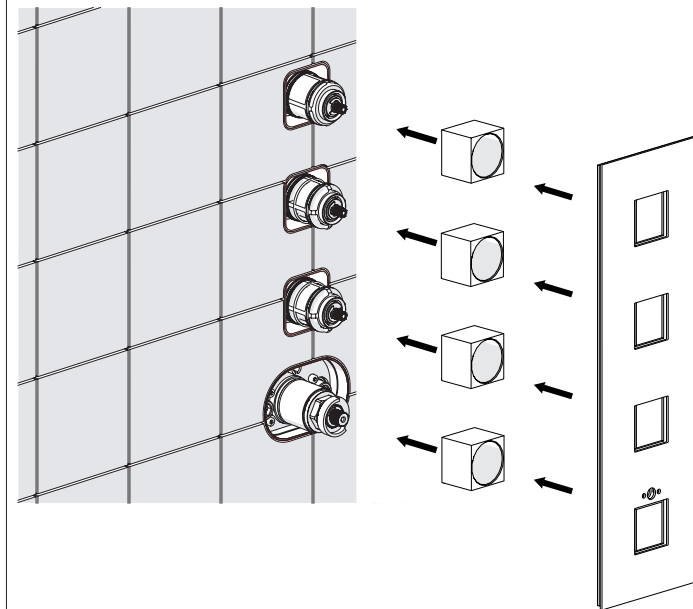

REF.
MANUAL
WE00103

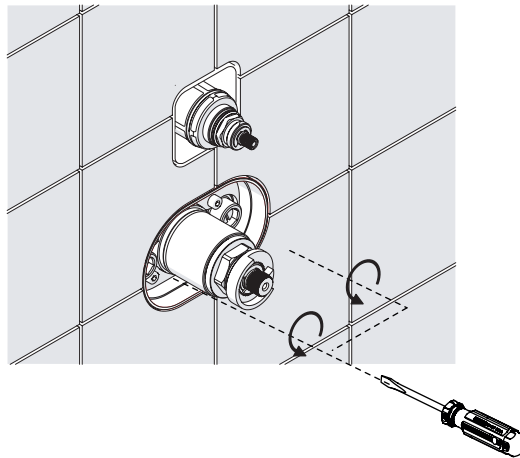
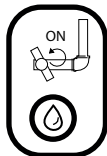
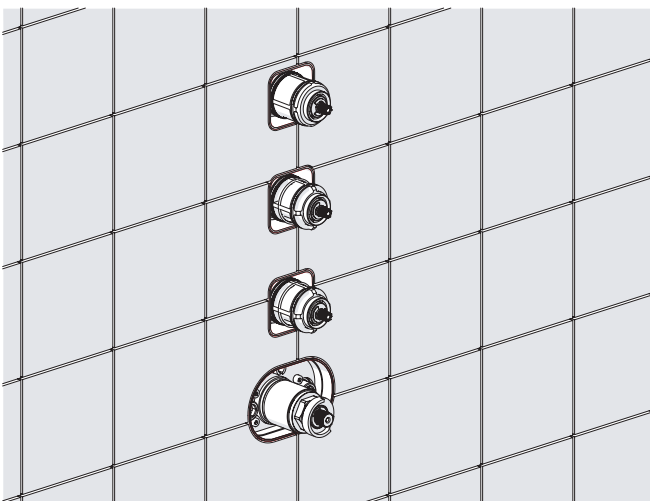

APERTO
OPEN

APERTO
OPEN

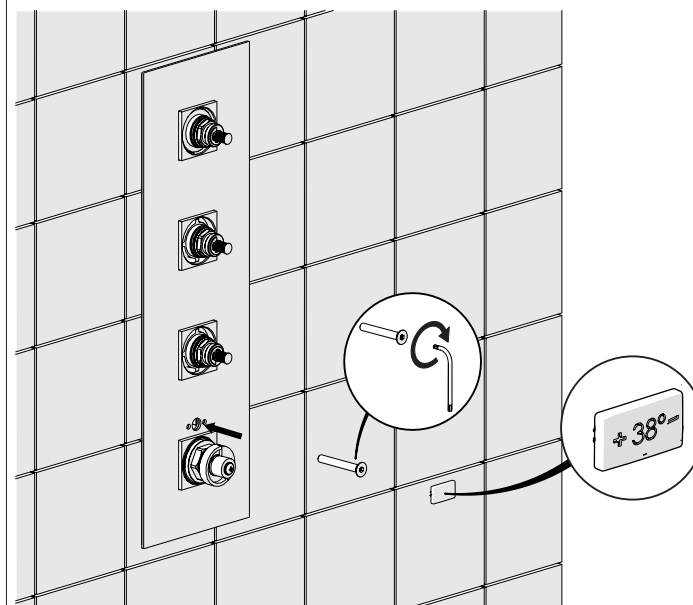

POSIZIONARE LA MANIGLIA CON CARTUCCIA CHIUSA COME IN FIGURA
 POSITION THE HANDLE WITH CLOSED CARTRIDGE AS SHOWN

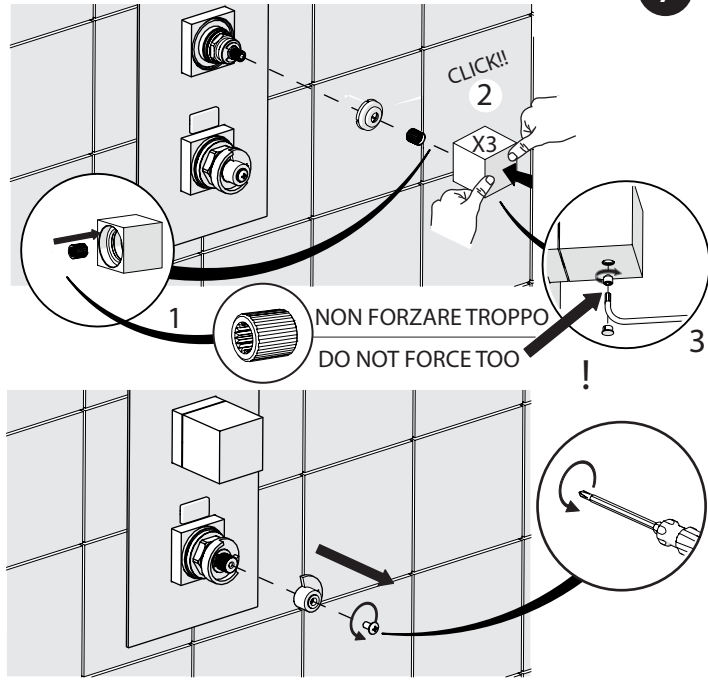

7

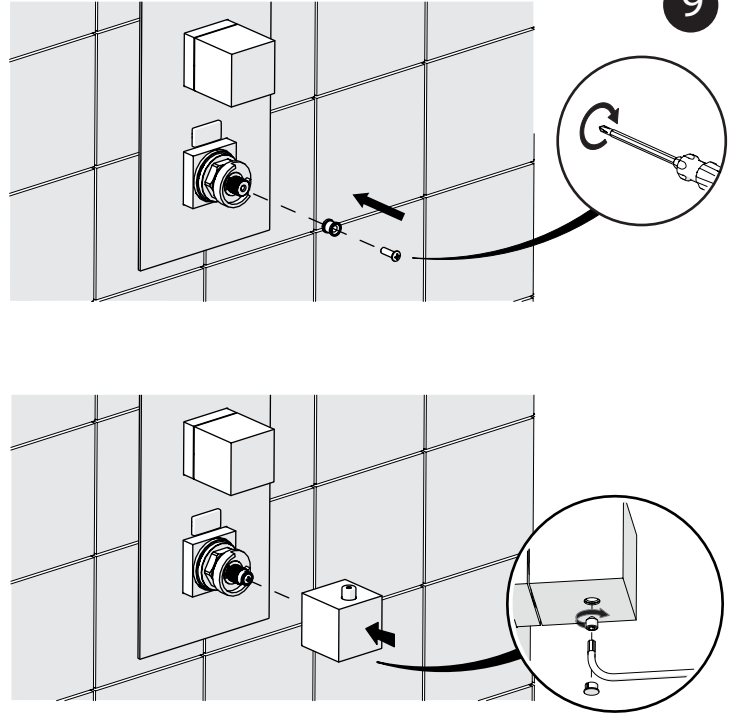

NOBILIS®
 The Best Technology for Water

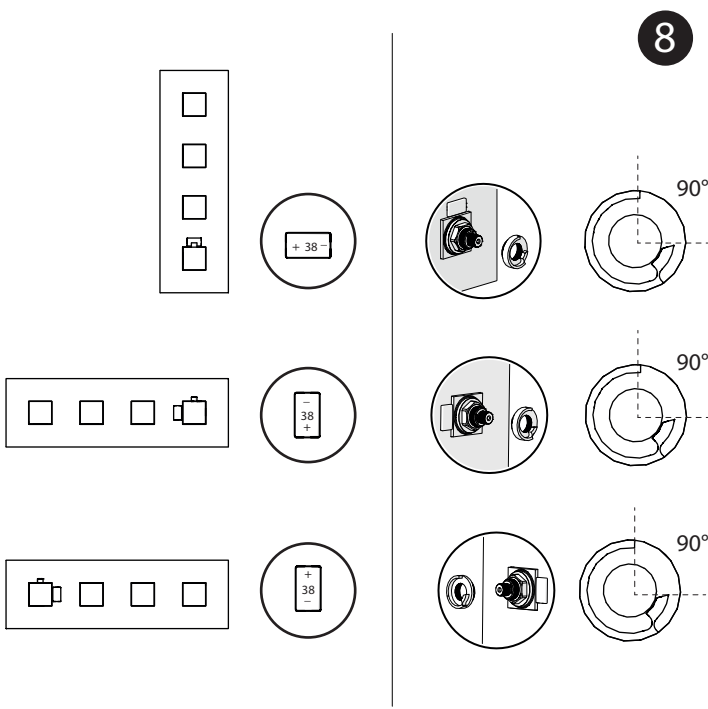
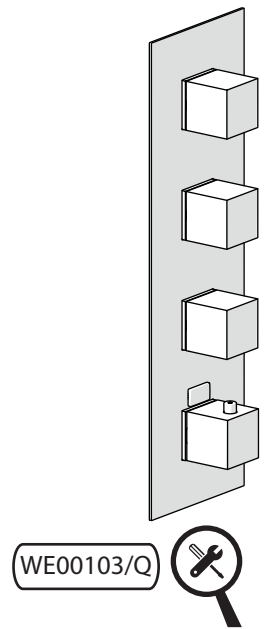

www.grupponobili.it

- MI102103
- CB00103
- SF00103
- RY00103
- TW00103

IISTR00103/Q#--STD

REV01/2013

