

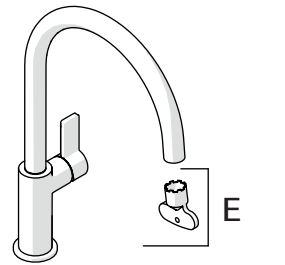

+



Not included / Non incluso / Non inclus / Nie zawarty / No incluido / Nao incluido



NON INCLUSO
NOT INCLUDED

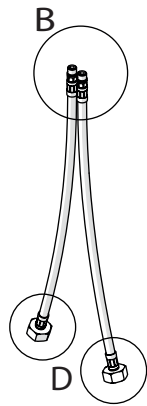
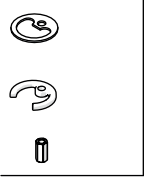
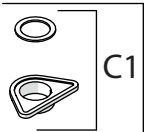
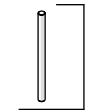

1

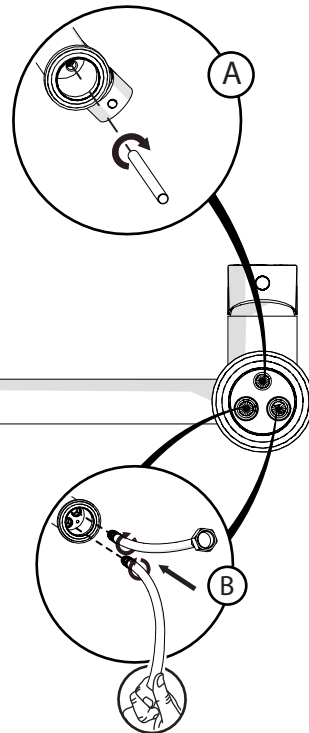
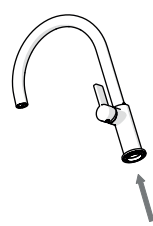
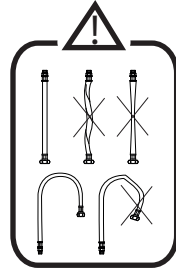

3

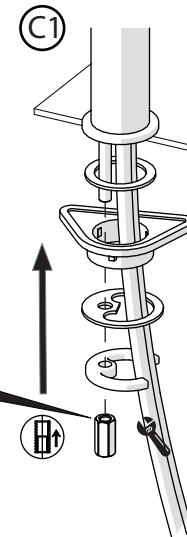
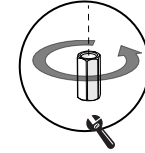

5

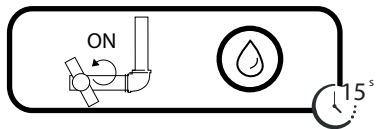

2

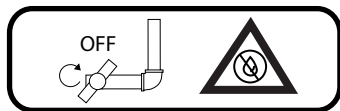
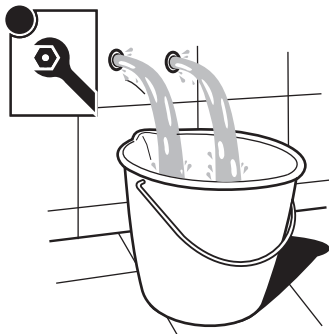

4

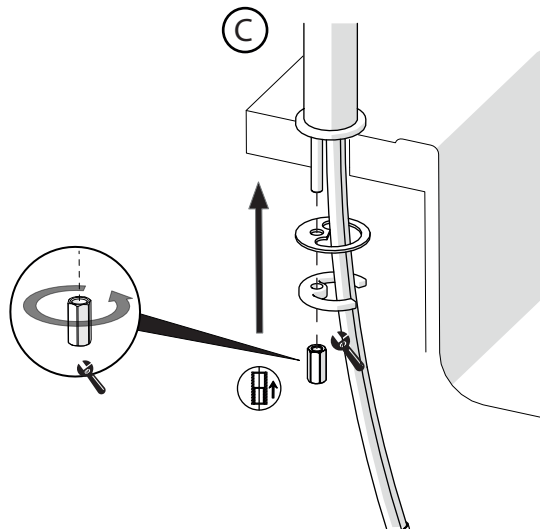
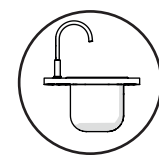

6

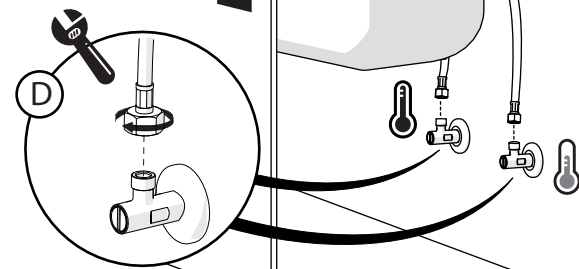
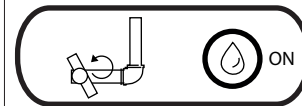

-50%

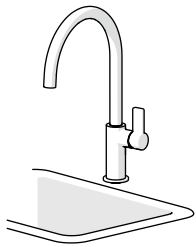

7

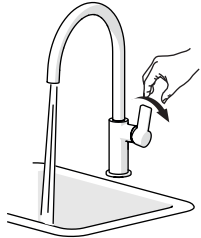

ON 50%

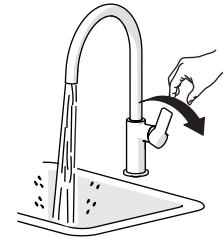

ON 100%

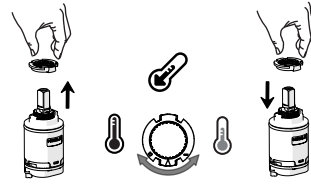

No limitation of temperature

Partial limitation of temperature

Maximum position Only cold water

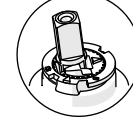
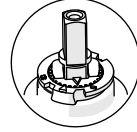
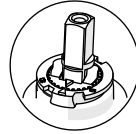

9

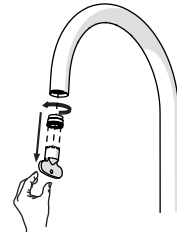

on

NOBILIS
The Best Technology for Water

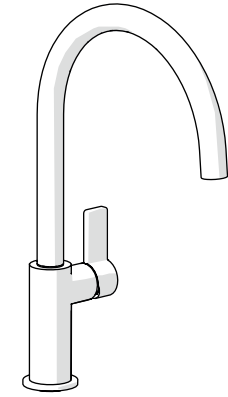

FL96113



www.grupponobili.it

IISTRFL96113#---STD

REV03/2013

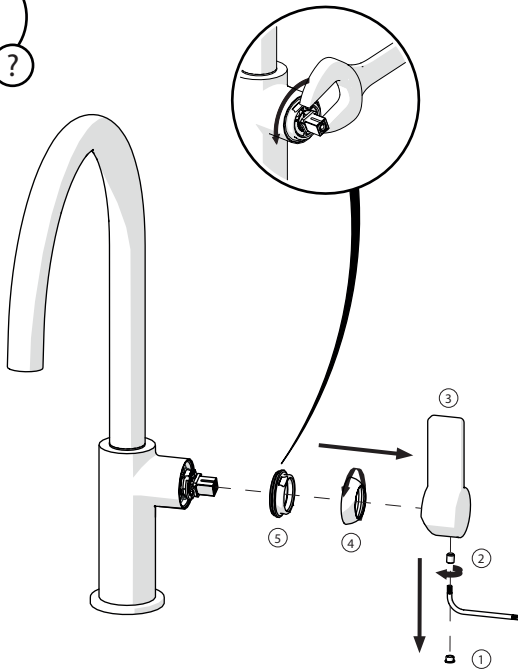

8

CLEANING

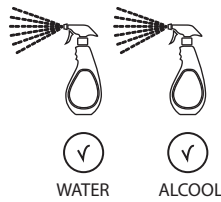

WATER

ALCOOL

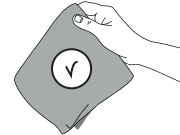

10

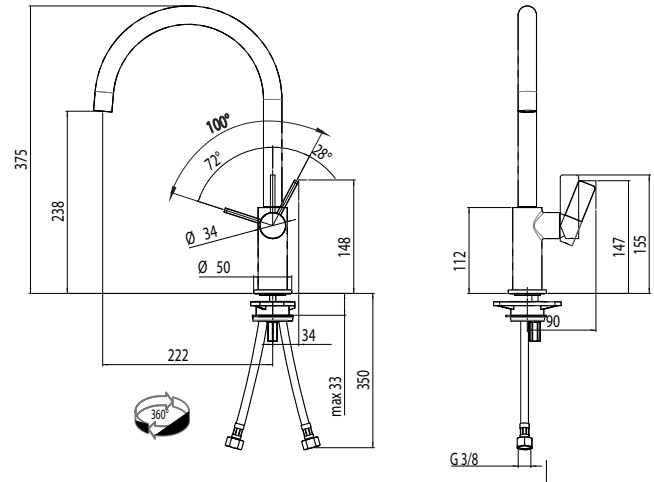

	P	P bar	0,5 MIN.	MAX 10		5		T	T ∞C		MAX 80		65 45
--	---	-------	----------	--------	--	---	--	---	------	--	--------	--	-------