

MA CHI NES

Index

02

Intro

10

Tartlet machines

28

Dosing machines

38

Cutting machines

48

Tempering machines

54

Dispensers

64

Planetary mixers

68

Other machines

80

Cookmatic recipes





MAN MADE MACHINES

Affidabili, robuste, fatte a mano in Italia. Pavoni Italia presenta la sua gamma di macchine dedicate alla pasticceria e alla ristorazione. Un'offerta pensata per i professionisti e concepita in collaborazione con i professionisti: macchine uniche perché progettate e sviluppate a partire dai loro consigli, assemblate con cura artigianale, capaci di ottime prestazioni. E pensate per durare, grazie anche a un servizio post vendita eccezionale, sempre garantito dalla qualità Pavoni Italia.

Reliable, durable, handmade in Italy. Pavoni Italia presents its range of machines for the pastry and catering sector. Our range is designed for and conceived in collaboration with professionals. Our machines are unique because they are designed and developed using their advice, are assembled with artisan care and capable of excellent performance. They are also designed to last thanks to an exceptional after-sales service guaranteed by the quality Pavoni Italia is known for.

Ci sono cuori che battono dietro le macchine

Lui è Emilio e guida il team di produzione macchine Pavoni Italia. Insieme conoscono ogni singola parte delle macchine; una squadra compatta che con il team Ricerca e Sviluppo ne disegna e coordina la realizzazione. Con alle spalle oltre 30 anni di esperienza, l'entusiasmo è lo stesso dei primi giorni: attenzione massima alla robustezza, ricerca di componenti di qualità, idee sempre votate al miglioramento dei flussi di lavoro e un pallino per il perfezionamento continuo della produzione. Produzione su cui tutta la squadra mette le mani, ogni singolo giorno.

The hearts behind the machines

This is Emilio. He leads the Pavoni Italia machine production team. They know every single part that goes into the machines. They are a compact team that, working hand in hand with the Research and Development team, designs and coordinates their production. With more than 30 years of experience behind them, the enthusiasm is the same as it was in the early days – maximum attention to durability, a relentless pursuit for quality components, ideas dedicated to improving workflows and a dedication to the continuous improvement of production. And production is something into which the whole team puts its hands, every single day.



Guarda il video dedicato alle **Macchine** sul canale Youtube di Pavoni Italia
Watch the video "**Machines**" on Pavoni Italia's Youtube channel

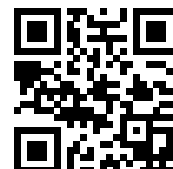





Prodotte con passione, seguite con cura

Il segreto della macchine Pavoni Italia è nelle persone. Ogni prodotto nasce ascoltando le necessità dei professionisti della pasticceria e della ristorazione, comprendendone le modalità di lavoro e i desideri. Qui nasce l'idea, che viene poi messa in pratica. La progettazione avviene in dettaglio negli uffici di ricerca e sviluppo e poi si avvia verso la produzione, curata componente per componente da mani esperte, alla ricerca della massima affidabilità. Con un'attenzione speciale al servizio post-vendita: la mano artigianale trova in questo campo il suo migliore terreno, revisionando in poche ore macchine pensate per durare nel tempo e poi rispedite prontamente ai clienti. Compagne di lavoro di tutti i giorni, sicure e sempre al tuo fianco.

Produced with passion, followed with care

The secret of Pavoni Italia machines is its people. Each product is created by listening to the needs of pastry and catering professionals and understanding their working methods and needs. Here the idea is born, which is then put into practice. The design is carried out in detail in the research and development offices and then goes on to production, where each machine is constructed component by component by expert hands with the ultimate goal being maximum reliability. Not to mention the special attention that is received in the after-sales servicing. This is where trained artisan hands work their magic, overhauling machines designed to last over time in just a few hours before being promptly returned to the customer. Everyday working companions – safe and always with you when you need them.

La garanzia della vostra soddisfazione

Le macchine Pavoni Italia vengono realizzate per un utilizzo facile e pratico, studiate negli ingombri e nel design al fine di velocizzare e migliorare il lavoro dei professionisti. Per fare ciò, la progettazione e realizzazione avviene ottemperando alle normative vigenti. Ogni singola macchina è sottoposta a rigorosi collaudi imposti dagli standard qualitativi interni di fabbricazione, ispirati alla norma UNI EN ISO 9001.

Your satisfaction, guaranteed

Pavoni Italia machines are made with a focus on ease and practical use. They have been engineered down to the finest details and designed to speed up and improve the work of professionals. To do this, the design and construction are carried out in compliance with current regulations. Every single machine is subjected to rigorous tests imposed by the internal manufacturing quality standards based on the UNI EN ISO 9001 standard.

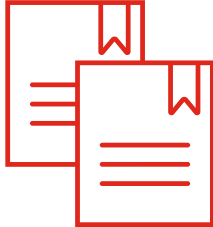

Progettate e realizzate nel rispetto delle normative:

- EN 60204-1 (sicurezza delle macchine - sicurezza elettrica)
- EN 12852 (sicurezza e igiene delle macchine per l'industria alimentare)

Designed and manufactured in compliance with the following regulations:

- EN 60204-1 (machine safety - electrical safety)
- EN 12852 (safety and hygiene of machinery for the food industry)



La dichiarazione di conformità, fornita in allegato alla macchina, attesta che la marcatura CE è stata applicata con riferimento a:

- Direttiva 2004/108/CE del 15/12/2004
- Direttiva 2006/95/CE del 12/12/2006
- Direttiva 2006/42/CE del Parlamento Europeo e del Consiglio del 17-05-2006
- Reg.CE 1935/2004 idoneità dei materiali al contatto diretto con alimenti
- Reg.CE 2023/2006 buone pratiche di fabbricazione (GMP)

Le macchine sono conformi al sistema di certificazione GOST R.

The declaration of conformity, which is attached to the machine, certifies that the CE marking has been applied with regard to:

- 2004/108/CE directive dated 15/12/2004
- 2006/95/CE directive dated 12/12/2006
- 2006/42/CE directive by the European Parliament and Council dated 17-05-2006
- CE 1935/2004 Reg. materials suitable for direct contact with foodstuffs
- CE 2023/2006 Reg. good manufacturing practices (GMP)

The machines comply with the GOST R certification system.





**TAR
TLET**

**MA
CHI
NES**

New Cookmatic

**Dai nuova forma alla perfezione.
Give perfection a new shape.**

Cookmatic è pensata per la produzione di basi, di tartellette e di pastafrolla dolce e salata. Un sistema semplice che permette di realizzare differenti forme e misure in poco tempo, grazie alle piastre intercambiabili. Tramite l'accoppiamento delle due piastre puoi ottenere tartellette perfette per dimensione e cottura. La nuova interfaccia permette una programmazione più intuitiva e rapida. Cookmatic è facile da pulire ed è adatta alla produzione in continuo per diverse ore. **2 anni di garanzia.**

Cookmatic is designed for the production of bases, tartlets and both sweet and savoury pastries. Thanks to the interchangeable plates, you will be able to make different shapes and sizes quickly. The combination of the two plates ensures the production of perfectly cooked and shaped tartlets. The new interface allows for faster and more intuitive programming. Cookmatic is easy to clean and suitable for continuous production over several hours. **2 year warranty.**

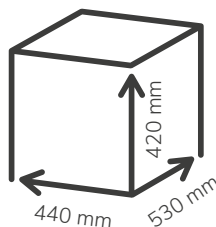

Dimensioni macchina chiusa
Closed machine dimensions

NEW

CODE	PESO WEIGHT (kg)	POTENZA ELETTRICA ELECTRICAL POWER (Watt)	TENSIONE ELETTRICA ELECTRICAL VOLTAGE (Volt)
NEWCOOKMATICPAV	28	3200	220/240 *110/380

* a richiesta
on demand



Guarda il video dedicato a **Cookmatic** sul canale Youtube di Pavoni Italia
Watch the video "**Cookmatic**" on Pavoni Italia's Youtube channel

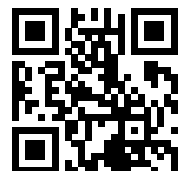

Piastre per Cookmatic

Plates for Cookmatic

Utilizzabili anche su Cookmatic Special - pag. 23

They can be use also with Cookmatic Special - pag. 23







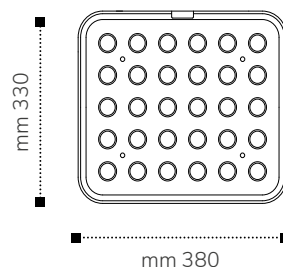



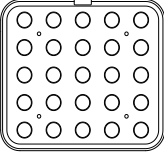

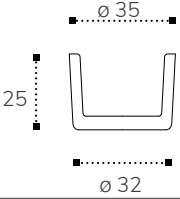
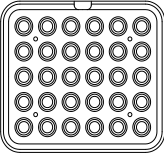

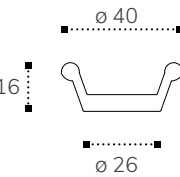
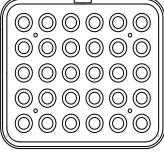

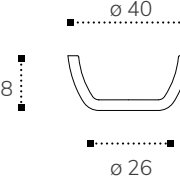
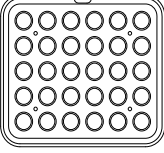
La tua libertà creativa è garantita da un'ampia selezione di forme realizzabili. Cookmatic monta due piastre di cottura: una superiore e una inferiore. Scegli tra le coppie di piastre disponibili - realizzate in materiale antiaderente - a seconda del tipo di tartelletta che desideri e cambiale in libertà con pochi semplici gesti.

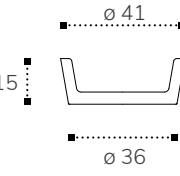
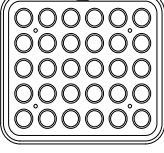

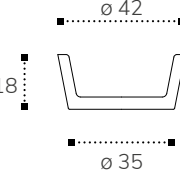
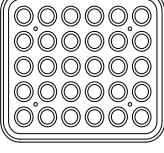

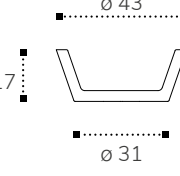
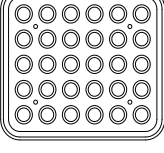

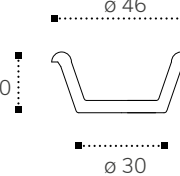
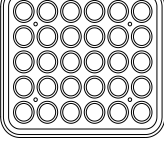

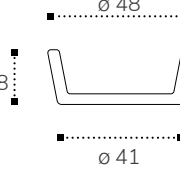

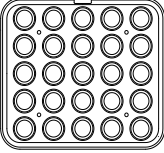

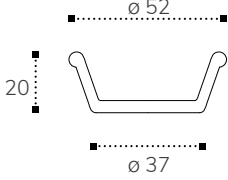
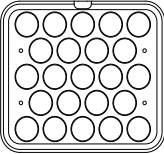

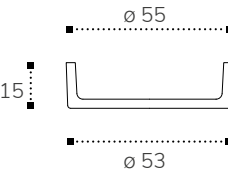
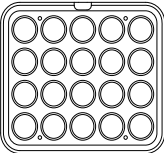

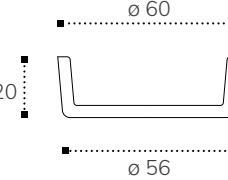
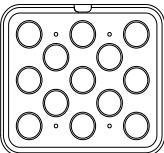
A wide selection of possible shapes guarantees your creative freedom. Cookmatic is provided with two cooking plates: an upper and a lower. All are made of non-stick material. Choose from the pairs of plates available for the type of tartlet you want. You can change them out whenever you want in just a few simple steps.

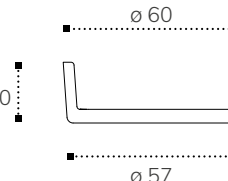
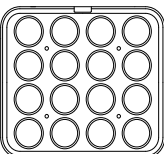

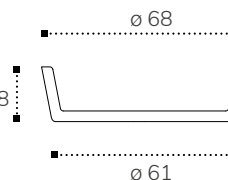
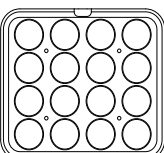

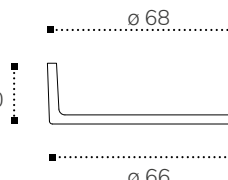
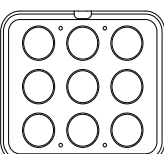

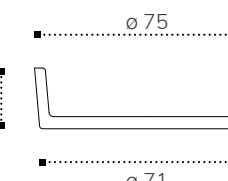
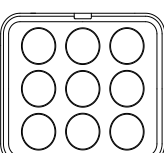

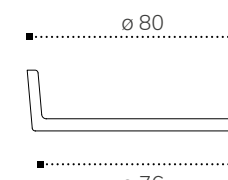

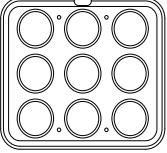
Peso piastra - Plate weight kg 11 (variabile a seconda della piastra - variable depending on the plate)

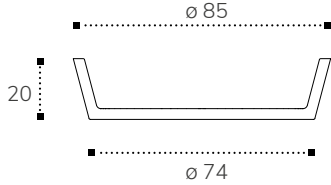
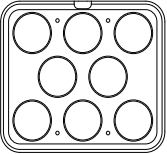

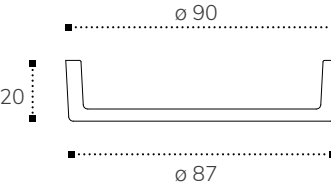
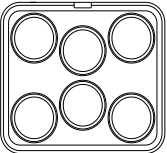

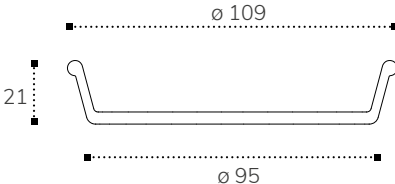
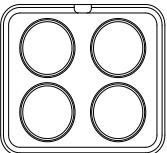
Eclair		CODE	DIMENSIONI DIMENSIONS (mm)	SPESSORE THICKNESS (mm)
		PIASTRA 39		pareti - borders 3,5 fondo - bottom 3,5
		PIASTRA 38		pareti - borders 3,5 fondo - bottom 3,5
Tonde - Rounded		CODE	DIMENSIONI DIMENSIONS (mm)	SPESSORE THICKNESS (mm)
		PIASTRA 9		pareti - borders 3 fondo - bottom 4

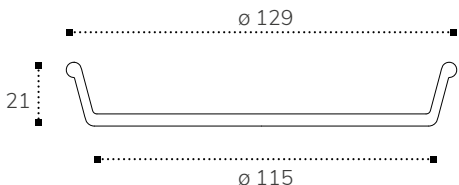
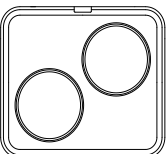
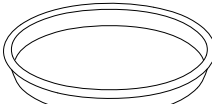
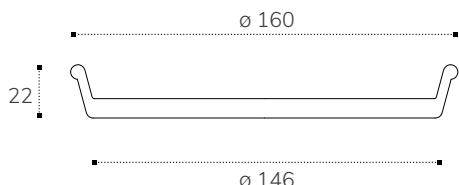
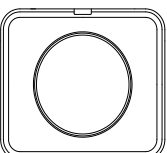

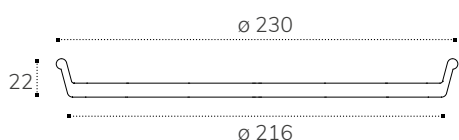
		CODE	DIMENSIONI DIMENSIONS (mm)	SPESSORE THICKNESS (mm)
		PIASTRA 15		pareti - borders 3,5 fondo - bottom 4,5
		PIASTRA D		pareti - borders 3 fondo - bottom 5,5
		PIASTRA 2		pareti - borders 3,5 fondo - bottom 3,5
		PIASTRA 52		pareti - borders 3,5 fondo - bottom 4
		PIASTRA 46		pareti - borders 3,5 fondo - bottom 4
		PIASTRA 42		pareti - borders 3,5 fondo - bottom 3,5
		PIASTRA O		pareti - borders 4 fondo - bottom 4
		PIASTRA 26		pareti - borders 4 fondo - bottom 3,5

		CODE	DIMENSIONI DIMENSIONS (mm)	SPESSORE THICKNESS (mm)
		PIASTRA 12	 <p>ø 52 20 ø 37</p>	pareti - borders 3,5 fondo - bottom 4
		PIASTRA 57	 <p>ø 55 15 ø 53</p>	pareti - borders 3 fondo - bottom 3
		PIASTRA 21	 <p>ø 60 20 ø 56</p>	pareti - borders 4 fondo - bottom 4
		PIASTRA 24	 <p>ø 60 20 ø 57</p>	pareti - borders 3,5 fondo - bottom 4,5
		PIASTRA 13	 <p>ø 68 18 ø 61</p>	pareti - borders 3,5 fondo - bottom 3,5
		PIASTRA 56	 <p>ø 68 20 ø 66</p>	pareti - borders 3 fondo - bottom 3
		PIASTRA 29	 <p>ø 75 20 ø 71</p>	pareti - borders 3,5 fondo - bottom 4
		PIASTRA W	 <p>ø 80 20 ø 76</p>	pareti - borders 3,5 fondo - bottom 4

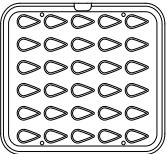

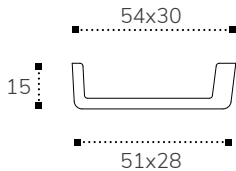

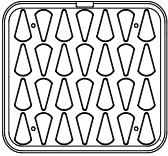

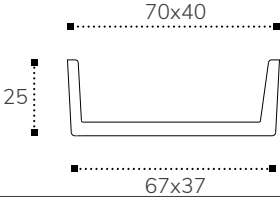
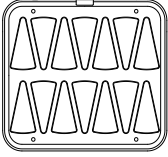
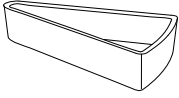
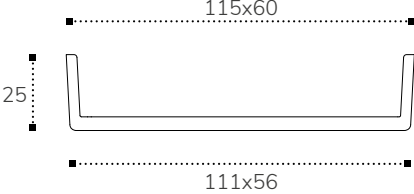
		CODE	DIMENSIONI DIMENSIONS (mm)	SPESSORE THICKNESS (mm)
		PIASTRA 41		pareti - borders 3,5 fondo - bottom 3,5
		PIASTRA 45		pareti - borders 5 fondo - bottom 4
		PIASTRA T		pareti - borders 3 fondo - bottom 4
		PIASTRA S		pareti - borders 3 fondo - bottom 4
		PIASTRA Z		pareti - borders 4 fondo - bottom 8
		PIASTRA V		pareti - borders 4 fondo - bottom 8

Triangolari - Triangular

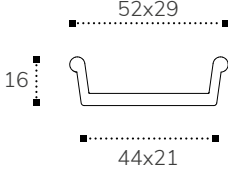
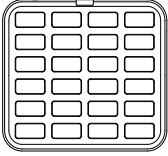

		CODE	DIMENSIONI DIMENSIONS (mm)	SPESSORE THICKNESS (mm)
		PIASTRA 22		pareti - borders 3,5 fondo - bottom 3,5

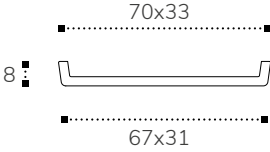

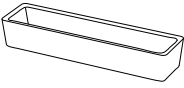
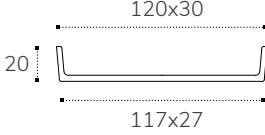



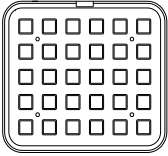

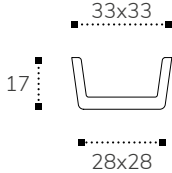



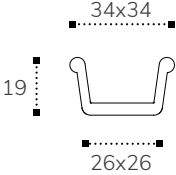
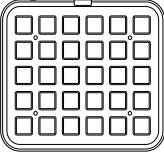

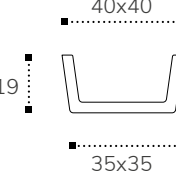
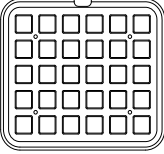
		CODE	DIMENSIONI DIMENSIONS (mm)	SPESSORE THICKNESS (mm)
		PIASTRA 19		pareti - borders 3,5 fondo - bottom 4,5
		PIASTRA 18		pareti - borders 3,5 fondo - bottom 4,5

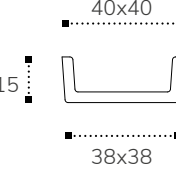
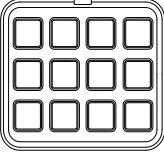
Rettangolari - Rectangular

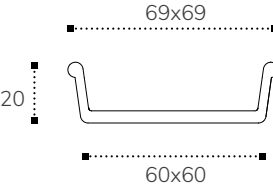
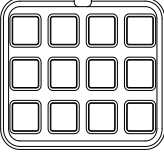

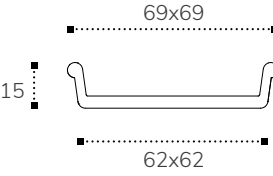
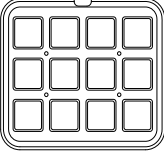
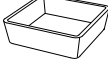
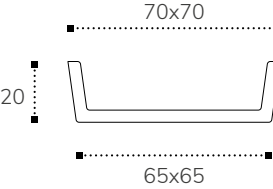
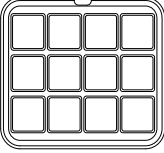

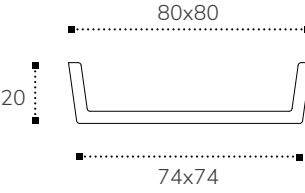
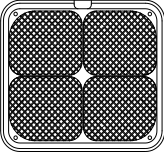
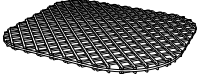
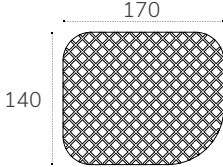

		CODE	DIMENSIONI DIMENSIONS (mm)	SPESSORE THICKNESS (mm)
		PIASTRA Q		pareti - borders 3 fondo - bottom 4
		PIASTRA 4		pareti - borders 3 fondo - bottom 3
		PIASTRA X		pareti - borders 3 fondo - bottom 3,5

Quadrate - Squared



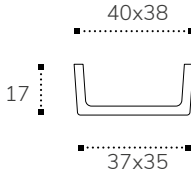
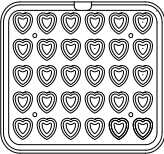

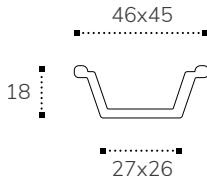
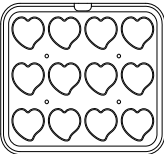

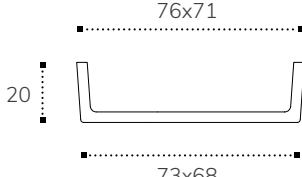

		CODE	DIMENSIONI DIMENSIONS (mm)	SPESSORE THICKNESS (mm)
		PIASTRA 10		pareti - borders 3 fondo - bottom 4

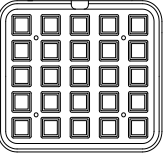

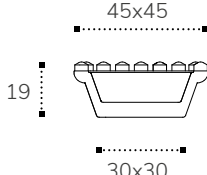
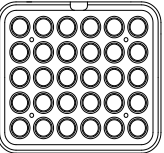

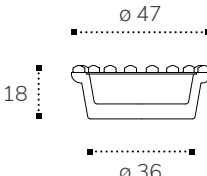

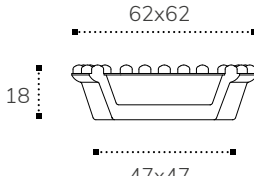
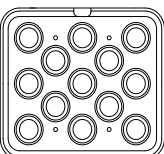
		CODE	DIMENSIONI DIMENSIONS (mm)	SPESSORE THICKNESS (mm)
		PIASTRA P	 <p>34x34 19 26x26</p>	pareti - borders 3 fondo - bottom 4
		PIASTRA 3	 <p>40x40 19 35x35</p>	pareti - borders 3,5 fondo - bottom 3,5
		PIASTRA 27	 <p>40x40 15 38x38</p>	pareti - borders 3,5 fondo - bottom 3,5
		PIASTRA UM	 <p>69x69 20 60x60</p>	pareti - borders 3 fondo - bottom 4
		PIASTRA U	 <p>69x69 15 62x62</p>	pareti - borders 3 fondo - bottom 4
		PIASTRA 34	 <p>70x70 20 65x65</p>	pareti - borders 4 fondo - bottom 4
		PIASTRA 35	 <p>80x80 20 74x74</p>	pareti - borders 4 fondo - bottom 4
		PIASTRA L	 <p>170 140</p>	5 :  : 2

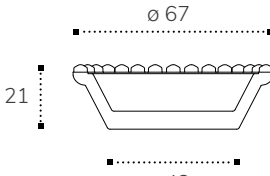
Cuore - Heart

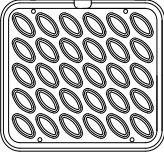

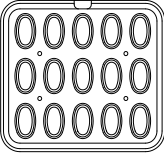

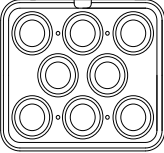
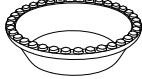
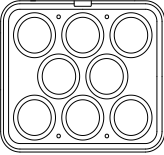

		CODE	DIMENSIONI DIMENSIONS (mm)	SPESSORE THICKNESS (mm)
		PIASTRA 60		pareti - borders 3 fondo - bottom 3
		PIASTRA 1		pareti - borders 3 fondo - bottom 3
		PIASTRA 59		pareti - borders 3,5 fondo - bottom 3,5



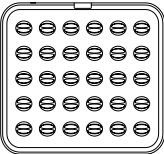

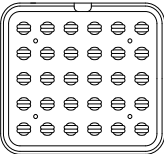

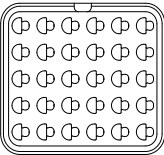

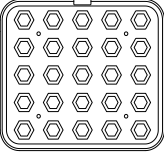

Festonate - Festooned

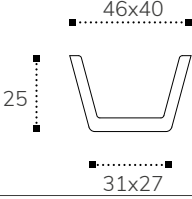
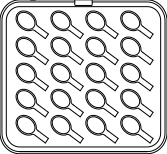
		CODE	DIMENSIONI DIMENSIONS (mm)	SPESSORE THICKNESS (mm)
		PIASTRA G		pareti - borders 3 fondo - bottom 5
		PIASTRA B		pareti - borders 3 fondo - bottom 5
		PIASTRA H		pareti - borders 3,5 fondo - bottom 5
		PIASTRA A		pareti - borders 4 fondo - bottom 6

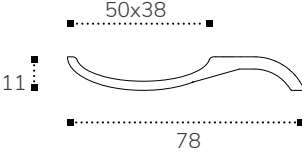
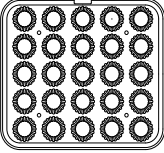
		CODE	DIMENSIONI DIMENSIONS (mm)	SPESSORE THICKNESS (mm)
		PIASTRA E	67x33 18 51x17	pareti - borders 3 fondo - bottom 5
		PIASTRA C	77x48 20 60x32	pareti - borders 3,5 fondo - bottom 5,5
		PIASTRA F	ø 90 25 ø 62	pareti - borders 3,5 fondo - bottom 6
		PIASTRA 6	ø 98 17 ø 78	pareti - borders 3 fondo - bottom 4

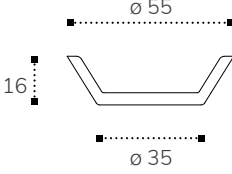
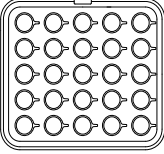
Altre forme - Other shapes

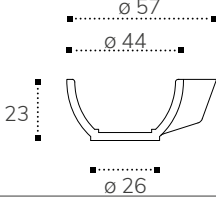
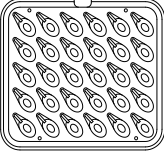
		CODE	DIMENSIONI DIMENSIONS (mm)	SPESSORE THICKNESS (mm)
		PIASTRA 5	17 39x33	pareti - borders 3 fondo - bottom 3
		PIASTRA N	18 40x34	pareti - borders 3 fondo - bottom 3,5
		PIASTRA Y	40x35 17	pareti - borders 3 fondo - bottom 3

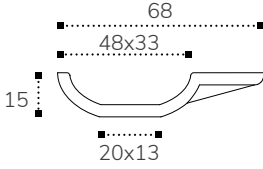
		CODE	DIMENSIONI DIMENSIONS (mm)	SPESSORE THICKNESS (mm)
		PIASTRA 14		pareti - borders 3,5 fondo - bottom 4,5
		PIASTRA K		pareti - borders fondo - bottom from 3 to 4
		PIASTRA 00		pareti - borders 3,5 fondo - bottom 4
		PIASTRA 8		pareti - borders 3 fondo - bottom 3
		PIASTRA R		pareti - borders 4 fondo - bottom 4

New Cookmatic Special

Per tartellette con altezze da record!
For tartlets with record heights!

Con Cookmatic Special puoi realizzare tartellette alte 45 mm, grazie allo speciale meccanismo di scorrimento regolabile in altezza brevettato da Pavoni Italia. Scegli tra le differenti coppie di piastre disponibili e realizza basi di varie forme per tartellette e pastafrolla dolce e salata: grazie all'accoppiamento perfetto delle due piastre otterrai tartellette sempre perfette per dimensione e cottura. La nuova interfaccia permette una più facile ed intuitiva programmazione. Cookmatic Special è facile da pulire ed è adatta alla produzione in continuo per diverse ore. **2 anni di garanzia.**

With Cookmatic Special you can create 45mm-high tartlets, thanks to the special height-adjustable sliding mechanism patented by Pavoni Italia. Choose from the different pairs of plates available and make bases of various shapes for tartlets and sweet and savoury pastries. The perfect coupling of the two plates will always give you perfectly-sized tartlets ready for cooking. The new interface allows for easier and more intuitive programming. Cookmatic Special is easy to clean and suitable for continuous production over several hours.

2 year warranty.

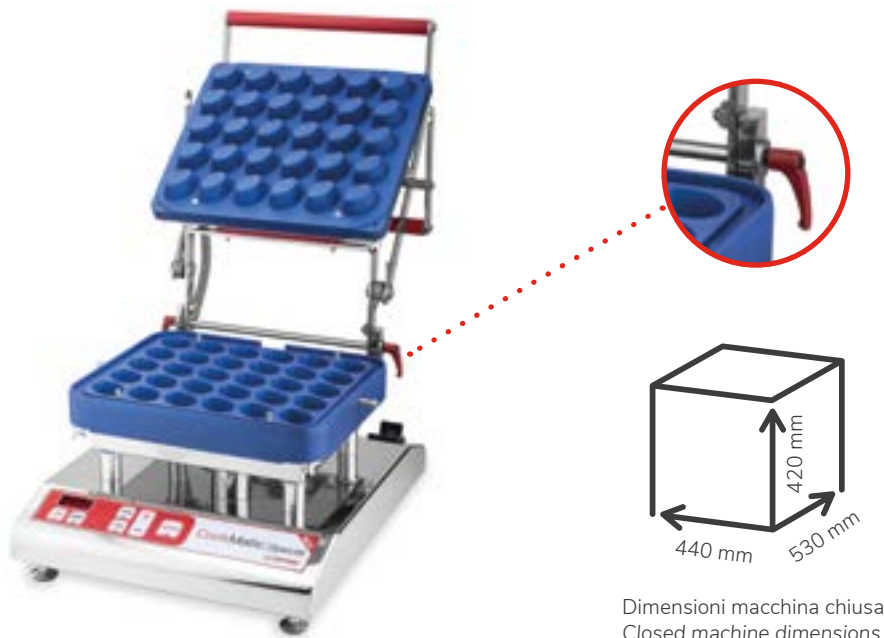

Dimensioni macchina chiusa
 Closed machine dimensions

NEW

CODE	PESO WEIGHT (kg)	POTENZA ELETTRICA ELECTRICAL POWER (Watt)	TENSIONE ELETTRICA ELECTRICAL VOLTAGE (Volt)
NEWCOOKMATICSPECIAL	28	3200	220/240 volt *110/380 volt

* a richiesta
 on demand

Piastre per Cookmatic Special

Plates for Cookmatic Special

Cookmatic Special ha una speciale selezione di piastre pensate per realizzare basi per tartellette più alte, da impiegare grazie allo speciale meccanismo di scorrimento per la regolazione in altezza.

Cookmatic Special has a special selection of plates designed to make bases for taller tartlets thanks to the special sliding mechanism for height adjustment.

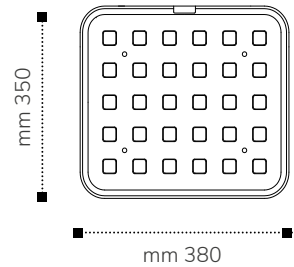

Peso piastra - Plate weight kg 15 (variabile a seconda della piastra - variable depending on the plate)

		CODE	DIMENSIONI DIMENSIONS (mm)	SPESSORE THICKNESS (mm)
		PIASTRA S05		pareti - borders 3,5 fondo - bottom 3,5
		PIASTRA S03		pareti - borders 3 fondo - bottom 3,5
		PIASTRA S04		pareti - borders 3,5 fondo - bottom 3,5

Accessori per New Cookmatic e Cookmatic Special New Cookmatic and Cookmatic Special accessories

Carrello in acciaio inox AISI 304 - AISI 304 stainless steel trolley



CODE	PESO WEIGHT (Kg)	DIMENSION (mm)
CARCOOK	22,5	550x460x840 h

2 ruote con freno e 2 normali Ø mm 100

2 wheels with brakes and 2 normal wheels Ø mm 100

Cookmatic Maxi

Maxi formato, maxi resa.
Large format, large yield.

Una grande novità per migliorare ancora di più la tua produttività. Con Cookmatic Maxi puoi realizzare fino al 50% in più di tartellette nello stesso tempo, grazie alle piastre di dimensioni maggiorate. Cookmatic Maxi è particolarmente adatta alla preparazione di basi medio-grandi sia dolci che salate, adatte sia alla pasticceria sia alla ristorazione. Ottieni cottura e dettagli sempre perfetti: programma il tuo lavoro con la nuova interfaccia, resa ancora più semplice ed intuitiva. Cookmatic Maxi è facile da pulire ed è adatta alla produzione in continuo per diverse ore. **2 anni di garanzia.**

*A big update that will improve your productivity even more. Thanks to the oversized plates, you can now make up to 50% more tartlets at the same time with Cookmatic Maxi. Cookmatic Maxi is ideal for the preparation of medium to large sweet and savoury bases suitable for both pastry and catering sector. The new simpler and more intuitive interface lets you program your work, so you get all your details just right and a perfect cook every time. Cookmatic Maxi is easy to clean and suitable for continuous production over several hours. **2 year warranty.***

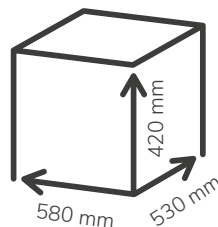

Dimensioni macchina chiusa
 Closed machine dimensions

NEW

CODE	PESO WEIGHT (kg)	POTENZA ELETTRICA ELECTRICAL POWER (Watt)	TENSIONE ELETTRICA ELECTRICAL VOLTAGE (Volt)
COOKMATICMAXI	37	5000	380 volt

Piastre per Cookmatic Maxi



Plates for Cookmatic Maxi

Piastre più grandi per una migliore produttività. Cookmatic Maxi ha una selezione dedicata di piastre di grande formato tra le quali scegliere, con le forme di maggiore impiego nel mondo del catering, della ristorazione e della pasticceria.

Larger plates for better productivity. Cookmatic Maxi has a dedicated selection of large format plates to choose from, including some of the most widely used moulds in the catering, restaurant and pastry world.

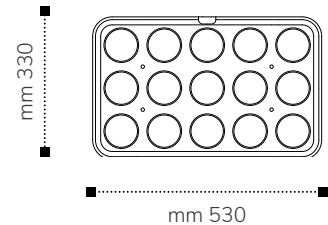
Peso piastra - Plate weight kg 15 (variabile a seconda della piastra - variable depending on the plate)

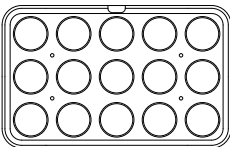
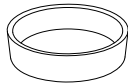
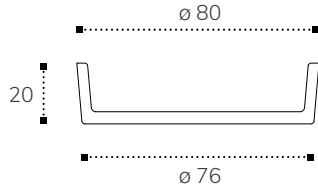
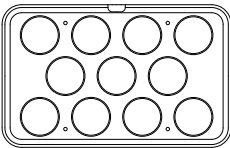

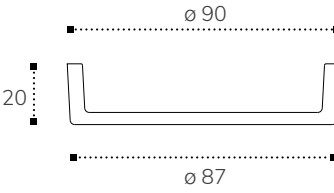
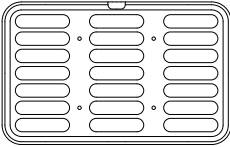
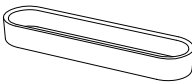
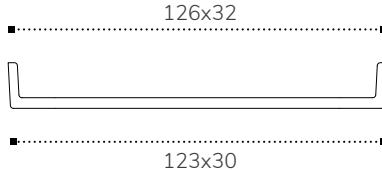
	CODE	DIMENSIONI DIMENSIONS (mm)	SPESSORE THICKNESS (mm)
 	MAXIW	 <p>ø 80 20 ø 76</p>	pareti - borders 3,5 fondo - bottom 4
 	MAXI45	 <p>ø 90 20 ø 87</p>	pareti - borders 5 fondo - bottom 4
 	MAXI38	 <p>126x32 15 123x30</p>	pareti - borders 3,5 fondo - bottom 3,5



Guarda il video dedicato a **Cookmatic Maxi** sul canale Youtube di Pavoni Italia
Watch the video "**Cookmatic Maxi**" on Pavoni Italia's Youtube channel







DOS ING MA CHI NES

Dosiplus Pro

Tecnologia avanzata per un dosaggio sempre corretto.
Advanced technology for a perfect dose every time.

Dosiplus Pro è progettata per dosare differenti preparati. La nuova interfaccia intuitiva e funzionale permette di impostare facilmente la programmazione e scegliere tra le 25 velocità di erogazione, rese possibili da un motore elettrico ancora più potente e silenzioso. La funzione reverse ha 5 parametri di regolazione, con funzione anti-goccia, per ridurre al massimo gli sprechi. Le tramogge accessorie con lobi in gomma consentono una perfetta erogazione di prodotti delicati e contenenti parti solide. Con Dosiplus Pro è possibile dosare, iniettare, spalmare e distribuire impasti fluidi, burro, formaggi cremosi, panna e creme, ma anche paste di nocciola, ripieni di frutta, miele, marmellate, salse, burro di arachidi, conserve, budini, yogurt e molto altro. **2 anni di garanzia.**

*Dosiplus Pro is designed to dose different mixes. The new intuitive and functional interface allows you to easily set the programming and choose from 25 dispensing speeds, thanks to an even more powerful and quieter electric motor. The reverse function has 5 adjustment parameters with anti-drip protection to reduce waste as much as possible. The accessory hoppers with rubber lobes allow for perfect dispensing of delicate products containing solid parts. With Dosiplus Pro it is possible to dose, inject, spread and distribute liquid batters, butter, creamy cheeses, cream and custards, as well as hazelnut pastes, fruit fillings, honey, jams, sauces, peanut butter, preserves, puddings, yoghurt and much more. **2 year warranty.***

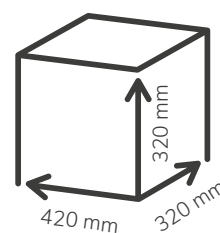
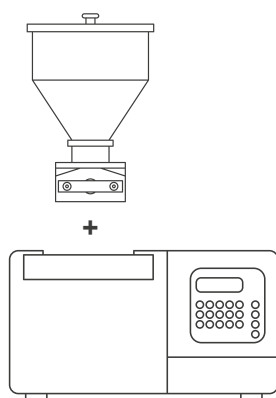

Dimensioni base
Base dimensions

CODE	PESO WEIGHT (kg)	POTENZA ELETTRICA ELECTRICAL POWER (Watt)	TENSIONE ELETTRICA ELECTRICAL VOLTAGE (Volt-Hz)
DOSIPLUSPRO	17	250	220/240 50/60

Il codice riportato in tabella corrisponde alla base - The code shown in the table corresponds to the base

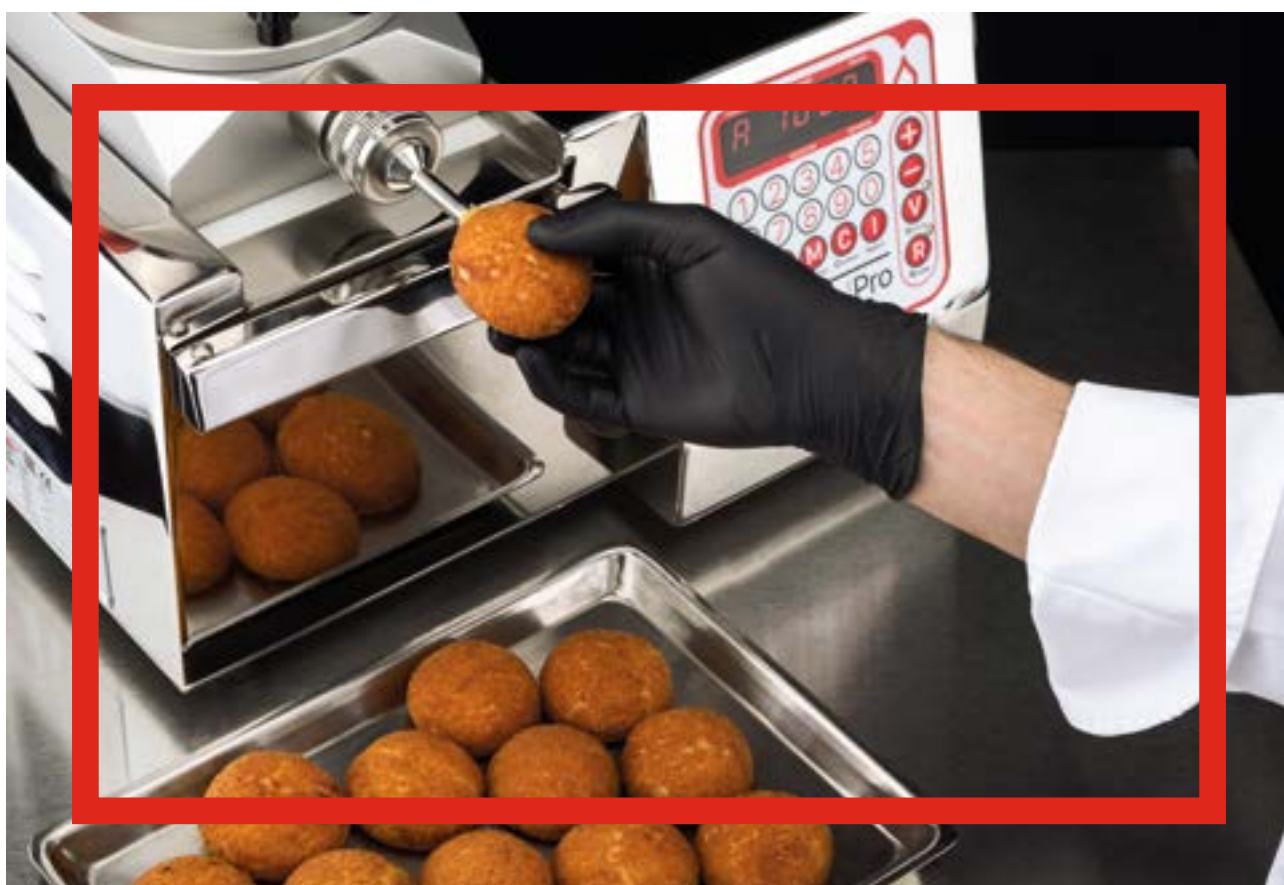

Guarda il video dedicato a **Dosiplus Pro** sul canale Youtube di Pavoni Italia
Watch the video "**Dosiplus Pro**" on Pavoni Italia's Youtube channel



Programmazione - Programming



Ciclo automatico
Automatic work cycle



Ciclo manuale
Manual work cycle



Ciclo continuo
Continuous work cycle



Regolazione velocità
Speed adjustment



Regolazione reverse
Reverse adjustment

Accessori per Dosiplus Pro - Dosiplus Pro accessories

Tramogge con imbuto acciaio INOX AISI 304 Hopper with INOX AISI 304 stainless steel funnel



Tramoggia con ingranaggio standard - Hopper with standard gear

Ideale per un uso standard e per tutti i tipi di lavorazione.

Ideal for standard use and all types of processing.



Tramoggia con ingranaggio a lobi in gomma - Hopper with robber lobes

Ideale per una perfetta lavorazione di prodotti delicati o viscosi contenenti parti solide di 3-4 mm senza romperle (mirtilli, granelle di nocciola, gocce di cioccolato...).

Ideal for perfect processing of delicate or viscous products containing 3-4 mm solid parts without breaking them (blueberries, ground hazelnut, chocolate chips, etc.).



CODE	CAPACITÀ CAPACITY (l)	DIMENSION (mm)	PESO WEIGHT (kg)	INGRANAGGIO GEAR
1099040	15	Ø 270x580 h	9,5	standard
GT15	15	Ø 270x610 h	11	lobi in gomma rubber lobes



CODE	CAPACITÀ CAPACITY (l)	DIMENSION (mm)	PESO WEIGHT (kg)	INGRANAGGIO GEAR
1099044	8	Ø 270x370 h	6	standard
GT8	8	Ø 270x400 h	7	lobi in gomma rubber lobes

Disco per tramoggia da 8 litri - 8 litre hopper disk

Utile strumento per schiacciare i composti più consistenti nella tramoggia e facilitare l'erogazione.

A useful tool for pressing dense compounds in the hopper and to facilitate dispensing.



CODE	DIMENSION (mm)
DISCO PER TRAMOGGIA	Ø 250x380 h

* Su richiesta disco tramoggia da 15 litri - 15 litre hopper disk available on request

Fascia riscaldante per tramoggia - Heating band for hopper

Fascia riscaldante per tramoggia in silicone rinforzato con regolatore di temperatura. Aggancio fascia con ganci e molle.

Reinforced silicone heating band for hoppers with temperature controller. Band secured with hooks and springs.



CODE	DIMENSION (mm)	POTENZA ELETTRICA ELECTRICAL POWER (Watt)	TENSIONE ELETTRICA ELECTRICAL VOLTAGE (Volt)
FS3271	500x250 h	650	240



Termostato temperatura regolabile - Adjustable thermostat temperature 0 - 180°C

Comando a pedale - Pedal control



P3026

Comando a pedale per lavoro a ciclo manuale.
Pedal control for manual work cycle.

Tubo flessibile - Flexible hose

Utilizzo con ogni beccuccio - For use with each spout



CODE	LUNGHEZZA LENGTH (mm)
FS3000	1000

Beccuccio uscita singola - Spout single outlet

Applicabili direttamente sul gruppo tramoggia - Can be applied directly to the hopper unit



F3042

ø beccuccio singolo - single
spout mm 6
Lunghezza beccuccio -
spout lenght mm 35



F3101

ø beccuccio singolo - single
spout mm 6
Lunghezza beccuccio - spout
lenght mm 37



F3212

Per farciture basi tonde
For filling round shells

ø mm 90
12 fori - hole



F3339

ø mm 6
Lunghezza - Lenght mm 100



F3097

ø mm 8
Lunghezza - Lenght mm 57



F3095

ø mm 8
Lunghezza - Lenght mm 111



F3090

ø mm 12
Lunghezza - Lenght mm 82,5



F3094

ø mm 12
Lunghezza - Lenght mm 89



F3091

ø mm 12
Lunghezza - Lenght mm 127



F3055

ø mm 14
Lunghezza - Lenght mm 90



F3067

ø mm 22
Lunghezza - Lenght mm 178

Beccuccio uscita doppia - Double output

Applicabili con FS3305 - Can be applied with FS3305 adaptor



FS3305

Adattatore per gruppo tramoggia a uscita singola
Adaptor for hopper unit with single outlet



F3066

ø mm 6
Lunghezza - Lenght mm 60



F3076

ø mm 8
Lunghezza - Lenght mm 61



F3064

ø mm 8
Lunghezza - Lenght mm 111



F3014

ø mm 12
Lunghezza - Lenght mm 82,5



F3011

ø mm 12
Lunghezza - Lenght mm 90



F3013

ø mm 12
Lunghezza - Lenght mm 127

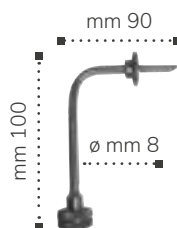

F3081

ø beccuccio - spout mm 6

Beccuccio a quattro uscite - 4-way spout

Studiato per riempire composti negli stampi in silicone.

Designed to fill silicone moulds.



F3071

ø mm 8
Lunghezza - Lenght mm 485

Adattatore bocchette - Tubes adaptor



F2741

Adattatore bocchette in plastica per FS3000 - Plastic adaptor nozzles for FS3000

Bocchette in plastica - Plastic nozzles



PB12

Kit 12 bocchette in plastica
Kit 12 plastic nozzles

PB24

Kit 24 bocchette in plastica
Kit 24 plastic nozzles

Beccuccio adattatore uscita singola - Adaptor spout with single outlet



F3141

∅ mm 22
Lunghezza - Length mm 200

Bocchette inox - Stainless steel nozzles

Bocchette inox per F3141 / FS3000 - Stainless steel nozzle for F3141 / FS3000



F2887

∅ mm 9,5



FS2760

∅ mm 12



FS2740

mm 10x5 h



FS2739

∅ mm 14

Beccucci ricopritori - Spouts

Beccucci ricopritori per F3141 e FS3000 - Spouts for F3141 e FS3000



CODE	LUNGHEZZA LENGTH (mm)
F2418	60
F2861	30

Regolatori di flusso antigoccia - Non-drip flow regulator



F3147

Con valvola allungata
With longer valve



F3187

Dosiemme

Dosatrice manuale con struttura in alluminio, stantuffo in acciaio inox, ugelli e pistone in acciaio AISI 304

Manual dosing machine with aluminium body, stainless steel plunger, funnel, nozzles and AISI 304 stainless steel piston.

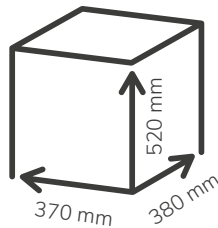

Inclusi - Included

- 3 iniettori Ø mm 5, 6 e 7 lunghezza mm 75
3 injectors Ø mm 5,6 and 7 lenght mm 75
- Valvolina - Valve
- Guarnizione - Gasket
- Chiave - Wrench

CODE	PESO WEIGHT (kg)	CAPACITÀ CAPACITY (l)	Ø PISTONE PISTON (mm)	DOSE DOSES (g)
DOSIEMME	7,2	7	31	da - from 1 a - up to 60

Dosimini

Dosatrice manuale con stantuffo in acciaio inox

Manual dosing machine with stainless steel plunger.

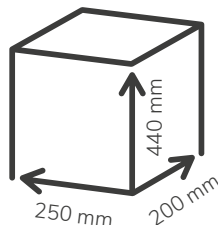

Inclusi - Included

- 3 iniettori Ø mm 5, 6 e 7 lunghezza mm 75
3 injectors Ø mm 5,6 and 7 lenght mm 75
- Valvolina - Valve
- Guarnizione - Gasket
- Chiave - Wrench

CODE	PESO WEIGHT (kg)	CAPACITÀ CAPACITY (l)	Ø PISTONE PISTON (mm)	DOSE DOSES (g)
DOSIMINI	2,7	3	24	da - from 1 a - up to 12





**CUT
TING**

**MA
CHI
NES**

Lira automatica

Automatic Lira

Tagli e porzionamenti perfetti, più in fretta.
Perfect cuts and portioning, faster.

Lira automatica è una taglierina elettrica semiautomatica che realizza tagli veloci e perfetti con notevole risparmio di tempo, evitando scarti di prodotto. È ideale per il taglio di ogni massa dura e congelata (anche contenente mandorle, nocciole e frutta secca in genere) e perfetta per la produzione al taglio di cremini, nocciolati, torroni morbidi, ganaches e piccola pasticceria. Il piano di taglio ha velocità di avanzamento regolabile con azionamento a pulsanti ed è interamente realizzato in acciaio inox AISI 304, facilmente smontabile per un'immediata pulizia anche in lavastoviglie. La sua capacità di taglio permette il porzionamento di prodotti alti fino a 6 cm e congelati fino a -15 °C. **2 anni di garanzia**

*Automatic Lira is a semi-automatic electric cutter which performs fast and perfect cuts that will save you time and avoid product waste. It is ideal for cutting any hard or frozen product (even those containing almonds, hazelnuts and dried fruit in general) and perfect for cutting cremini, hazelnut chocolates, soft nougat, ganaches and small pastries. The cutting base has adjustable feeding speed with push-button operation and is entirely made of AISI 304 stainless steel. The base is easily removable for immediate cleaning and is dishwasher safe. Its cutting capacity allows the portioning of products up to 6 cm high and frozen down to -15 °C. **2 year warranty***



Vassoio e spatola inclusi
Tray and spatula included

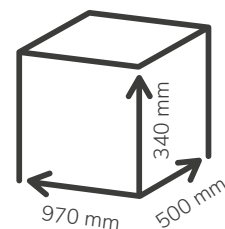

CODE	PESO WEIGHT (kg)	POTENZA ELETTRICA ELECTRICAL POWER (Watt)	TENSIONE ELETTRICA ELECTRICAL VOLTAGE (Volt - HZ)	DIM PIANO DI TAGLIO SIZE CUTTING FRAMEWORK (mm)
LIRA/E	50	180	220/240 - 50/60 * 110 - 50/60	400x400x60 h

* a richiesta - on demand

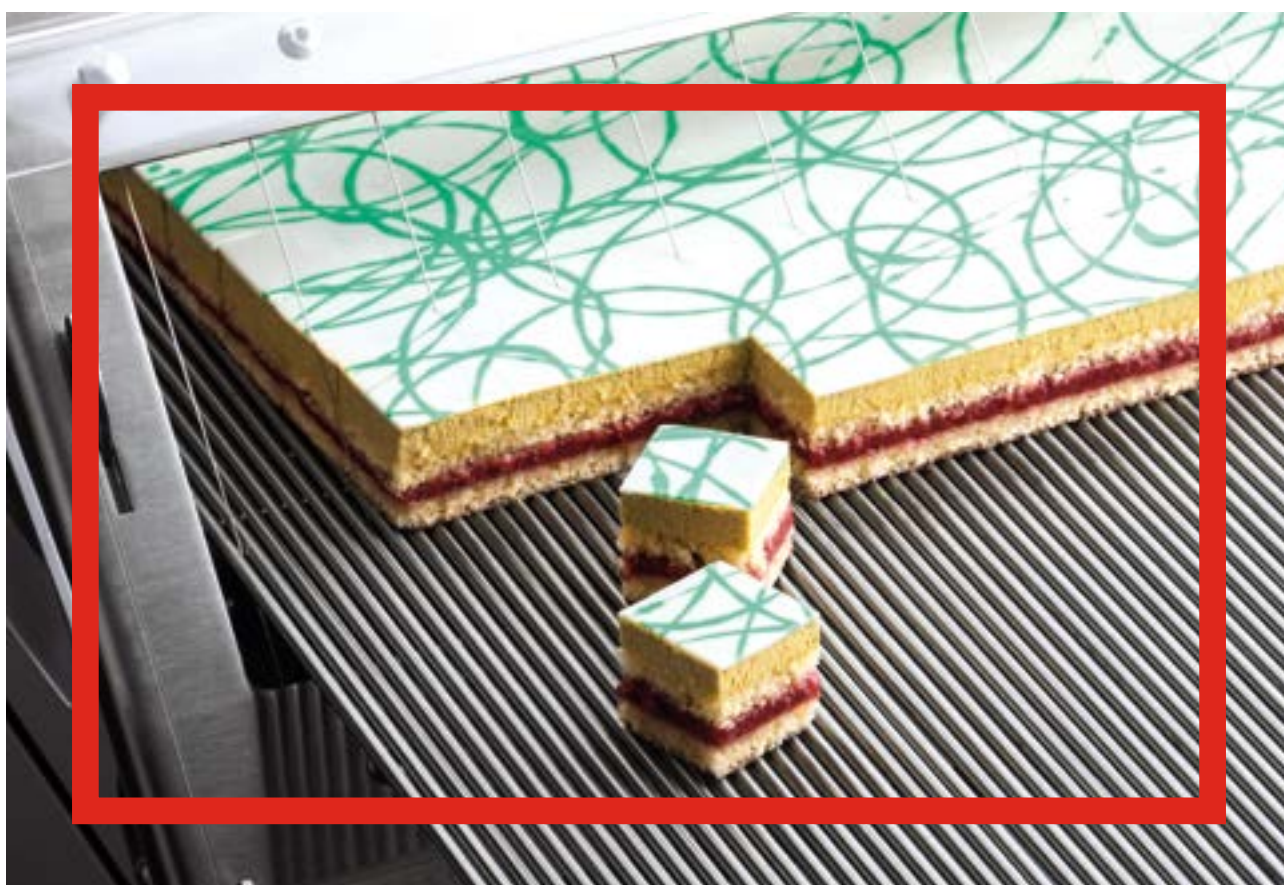
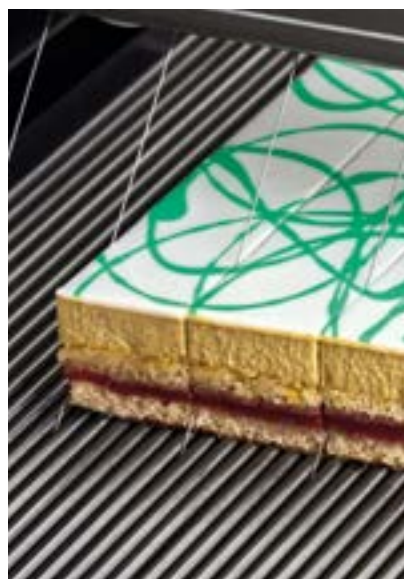

Guarda il video dedicato a **Lira automatica** sul canale Youtube di Pavoni Italia
Watch the video "**Automatic Lira**" on Pavoni Italia's Youtube channel



Lira manuale

Manual Lira

Controllo manuale, perfezione meccanica.
Manual control, mechanical perfection.

Lira manuale è pensata per il taglio di masse dure, anche contenenti mandorle, nocciole e frutta secca, oltre al porzionamento di cremini, nocciolati, torroni morbidi, ganache, piccola pasticceria (mousse, semifreddi, bavaresi), gelatine, biscotteria, marzapane. L'avanzamento del piano avviene tramite una manovella che consente di regolare la velocità in fase di taglio. La struttura di Lira manuale è in acciaio verniciato, tutte le componenti a contatto con i preparati sono realizzate in acciaio AISI 304 nel rispetto delle norme alimentari vigenti. Il piano è smontabile per una facile pulizia, anche in lavastoviglie. **2 anni di garanzia.**

*Manual Lira is designed for cutting hard products, even those containing almonds, hazelnuts and dried fruit, as well as portioning cremins, hazelnut chocolates, soft nougat, ganache, small pastries (mousses, semifreddi, bavaroises), jellies, biscuits and marzipan. The cutting base is advanced manually by means of a hand wheel that allows for manual speed adjustments during the cutting phase. The body of the manual Lira is painted steel. All the components which come into contact with food are made of AISI 304 steel in compliance with the food regulations in force. The base can be disassembled for easy cleaning and is dishwasher safe. **2 year warranty.***

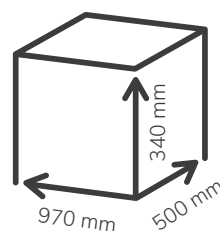
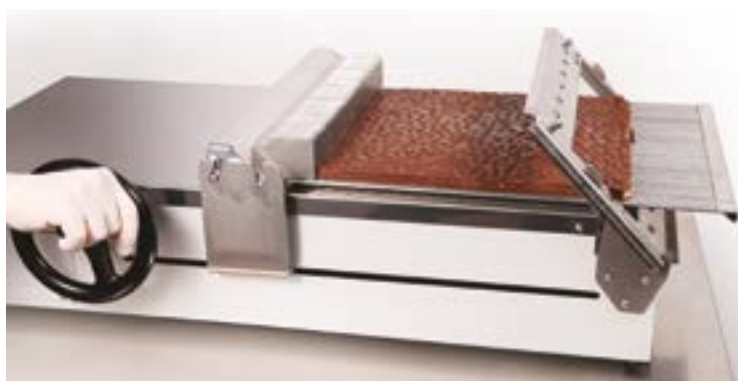

Vassoio e spatola inclusi
Tray and spatula included



CODE	PESO WEIGHT (kg)	DIM PIANO DI TAGLIO SIZE CUTTING FRAMEWORK (mm)
LIRA/M	41	400x400x60 h

Accessori per Lira automatica e manuale

Automatic and manual Lira accessories

Telai di taglio - Cutting frames



CODE	INTERASSE FILI WIRE WHEELBASES (mm)	CODE	INTERASSE FILI WIRE WHEELBASES (mm)
LT05H6	5	LT35H6	35
LT10H6	10	LT40H6	40
LT15H6	15	LT45H6	45
LT20H6	20	LT50H6	50
LT25H6	25	LT60H6	60
LT30H6	30		

* Altre misure di telaio a richiesta (multipli di 5 mm) - Other frame sizes on request (5 multiple mm)

Carrello in acciaio - Stainless steel trolley



CODE	PESO WEIGHT (kg)	DIMENSION (mm)
CARRELLO LIRA	36	1000x530x800 h

Chitarra singola

Single Guitar

Il modo più semplice per tagliare ganache e masse morbide.
The easiest way to cut ganaches and soft foods.

Un taglio sempre preciso e dritto, per dare ai tuoi prodotti il migliore aspetto in vetrina. La chitarra ad azionamento singolo è composta da una base di taglio in alluminio anodizzato, telai in materiale di alta qualità e struttura in acciaio inox AISI 304. È facilmente smontabile per una rapida pulizia ed è compatibile con i telai di taglio accessori, quadri per ganache e carrello.

Perfectly straight cuts will make the products in your shop window irresistible to passers-by. The single-drive guitar cutter consists of an anodized aluminium cutting base, high quality material frames and an AISI 304 stainless steel body. It is easily removable for quick cleaning and is compatible with additional cutting frames, ganache frames and trolley.



3 telai inclusi
3 cutting frames included

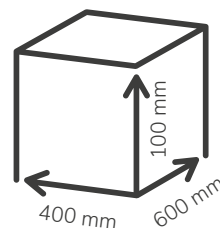

Dimensioni base
 Base dimensions

CODE	PESO WEIGHT (kg)	DIM PIANO DI TAGLIO SIZE CUTTING FRAMEWORK (mm)
CHITARRA	28	360x360

Chitarra doppio taglio Double Guitar

Due passaggi, un unico risultato straordinario.
Two steps, one extraordinary result.

Il modo più efficace di creare porzioni perfette. Il doppio meccanismo permette di tagliare rapidamente il prodotto in un'unica operazione. La base di taglio è in alluminio anodizzato, la struttura in acciaio inox AISI 304 nel rispetto delle norme vigenti e i telai sono pensati per la massima robustezza. È facilmente accessoriabile con differenti telai di taglio, vassoio e spatola, quadri per ganache e il comodo carrello in acciaio. Tutta la struttura è smontabile per agevolare le operazioni di pulizia e manutenzione.

The most effective way to get perfect portions. The double mechanism allows you to quickly cut the product in a single step. The cutting base is in anodized aluminium, the body is AISI 304 stainless steel in compliance with current standards and the frames are designed for maximum durability. You can easily accessorise it with different cutting frames, trays, spatulas or squares for ganache, as well as a convenient steel trolley. The entire body can be disassembled to make cleaning and maintenance easy.

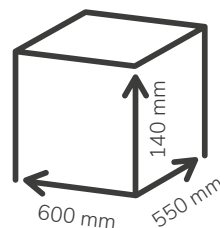

CODE	PESO WEIGHT (kg)	DIM PIANO DI TAGLIO SIZE CUTTING FRAMEWORK (mm)
BCD/I	29	360x360

Telai non inclusi - Cutting frames not included

Accessori per chitarra a doppio taglio e singola

Single and two-way Chitarra accessories

Telai di taglio - Cutting frames



CODE	INTERASSE FILI INTERAXIS (mm)
TCH7.5	7,5
TCH15	15
TCH22.5	22,5
TCH30	30
TCH37.5	37,5

Altre misure di telaio a richiesta (multipli di 5 mm) - Other frame sizes on request (5 multiple mm)

Quadri inox ganache - Stainless steel frames



CODE	DIM. INTERNE INSIDE DIM. (mm)	ALTEZZA HEIGHT (mm)
QG3	360x360	3
QG5	360x360	5
QG10	360x360	10
QG15	360x360	15

Carrello in acciaio - Stainless steel trolley



CODE	PESO WEIGHT (kg)	DIMENSION (mm)
CCH	40	700x580x870 h

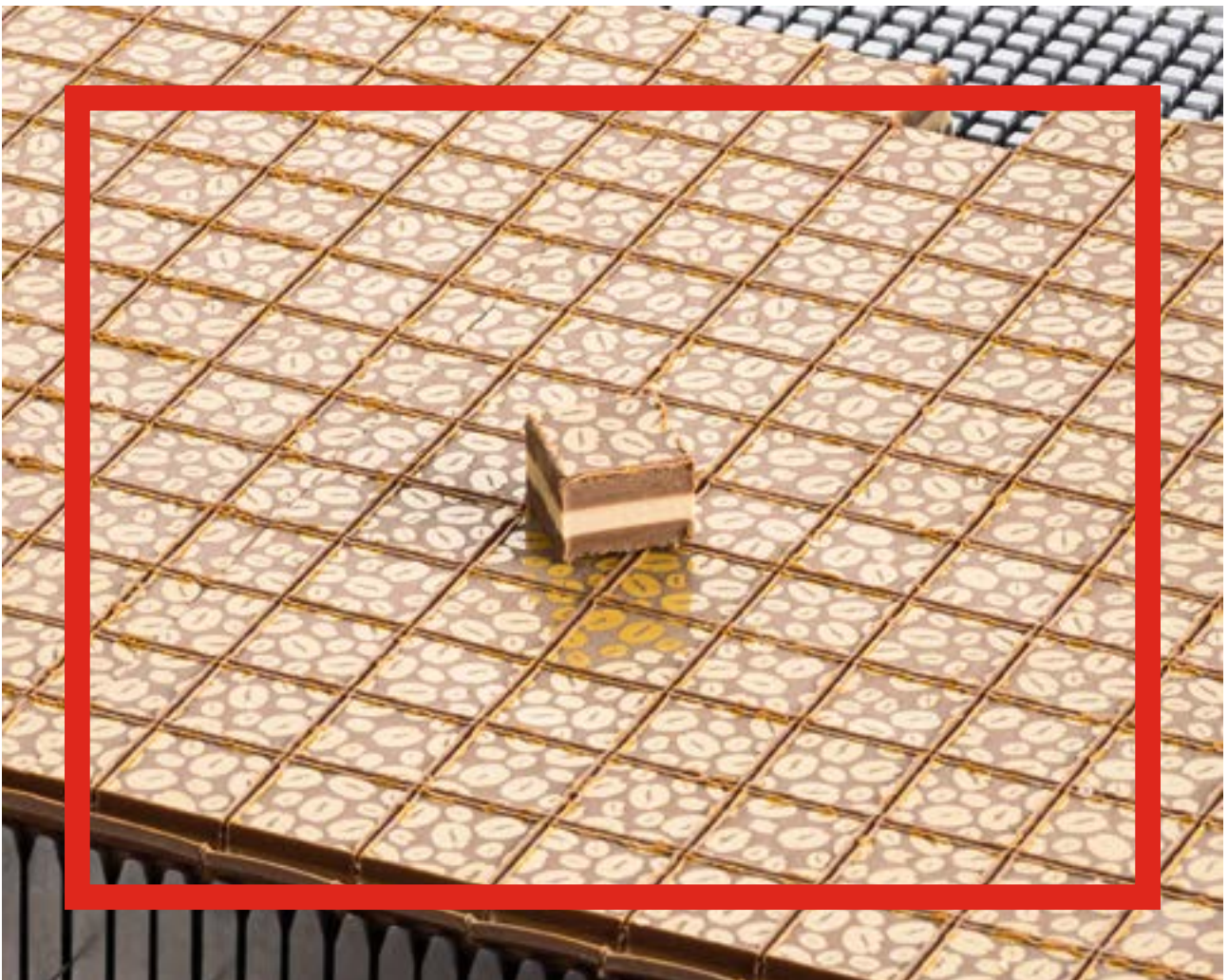
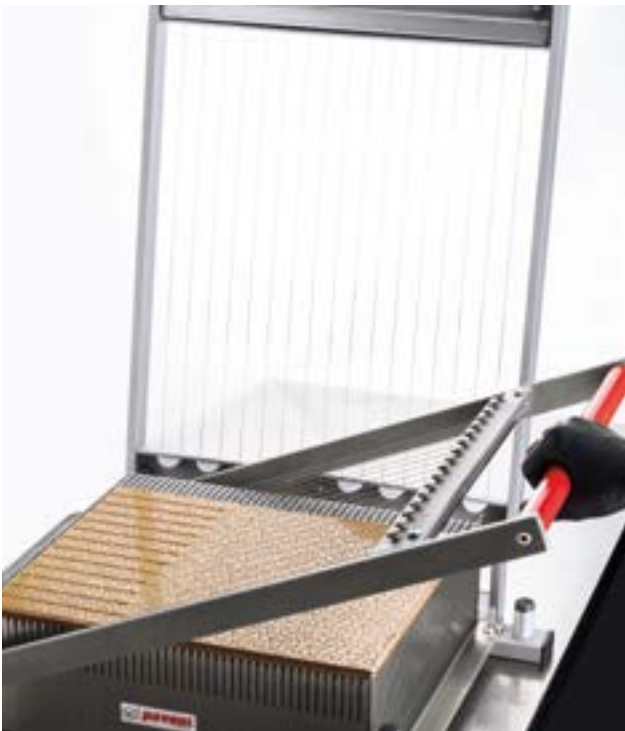





**TEM
PER
ING**

**GLA
ZING**

Minitemper

Una mini dal cuore grande.
A small machine with a big heart.

Minitemper è la temperatrice da banco di piccole dimensioni, semplice da utilizzare e con un ottimo rapporto qualità/prezzo. Minitemper mantiene il cioccolato in tempera per diverse ore, anche grazie ai programmi personalizzabili. Le bacinelle sono intercambiabili, per la massima comodità d'impiego e riduzione dei tempi morti di lavoro. Struttura e bacinella sono realizzate in acciaio inox AISI 304, coperchio trasparente in PET per il mantenimento della temperatura nel totale rispetto delle normative igieniche. **2 anni di garanzia.**

*Minitemper is a small, simple to use bench tempering machine that represents excellent value-for-money. Minitemper keeps chocolate tempered for several hours thanks to the customisable programs. The interchangeable bowls allow for reduced downtime and maximum ease of use. Body and bowl are made of AISI 304 stainless steel, transparent PET lid to maintain the temperature in total compliance with hygiene regulations. **2 year warranty.***

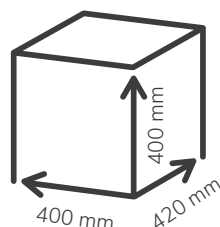

CODE	PESO WEIGHT (kg)	POTENZA ELETTRICA ELECTRICAL POWER (Watt)	CAPACITÀ CAPACITY (l/kg)	TENSIONE ELETTRICA ELECTRICAL VOLTAGE (Volt-Hz)
MINITEMPER	16	300	5 3	220/240 - 50 *220/240 - 60 *110 - 60

* a richiesta - on demand



Guarda il video dedicato a **Minitemper** sul canale Youtube di Pavoni Italia
Watch the video "**Minitemper**" on Pavoni Italia's Youtube channel



Glass-ice

Glassatura perfetta senza sprechi. Perfect glazing with no waste.

Veloce e pratica, Glass-ice permette di glassare in modo uniforme i prodotti, evitando gli sprechi di materia prima e massimizzando l'efficacia in laboratorio, riducendo i tempi di esecuzione. Glass-ice ha un recipiente di grandi dimensioni da riempire con cioccolato, zucchero, fondant e molto altro. È facile da usare: con un semplice gesto della mano permette di glassare 100 paste mignon in 15 secondi. La vaschetta di recupero permette di non sprecare il prodotto utilizzato e l'ampia base di lavoro consente la glassatura di prodotti con le più svariate forme e dimensioni. È possibile glassare con diversi colori senza dover pulire la macchina ad ogni cambio di prodotto e, una volta spruzzato il prodotto, si può intervenire con ulteriori decori senza levare i manufatti dalla glassatrice.

Fast and practical, Glass-ice uniformly and evenly ices products, avoids wasting raw materials, maximises efficiency, and reduces preparation times. Glass-ice features a large container you can fill with chocolate, sugar, fondant and much more. It is easy to use. With a simple gesture of the hand it can ice 100 mini-pastries in just 15 seconds. The tray underneath recovers the product dispensed, and the wide working base can accommodate the most varied shapes and sizes for icing. You can ice with different colours without having to clean the machine every time the product is changed and, once the product has been sprayed, further decorations can be made without having to remove the products from the machine.

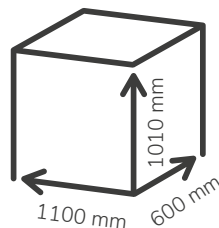

CODE	PESO WEIGHT (kg)	POTENZA ELETTRICA ELECTRICAL POWER (Watt)	TENSIONE ELETTRICA ELECTRICAL VOLTAGE (Volt-Hz)
GLASS-ICE	50	700	220/240 - 50 * 110 - 60

* a richiesta - on demand

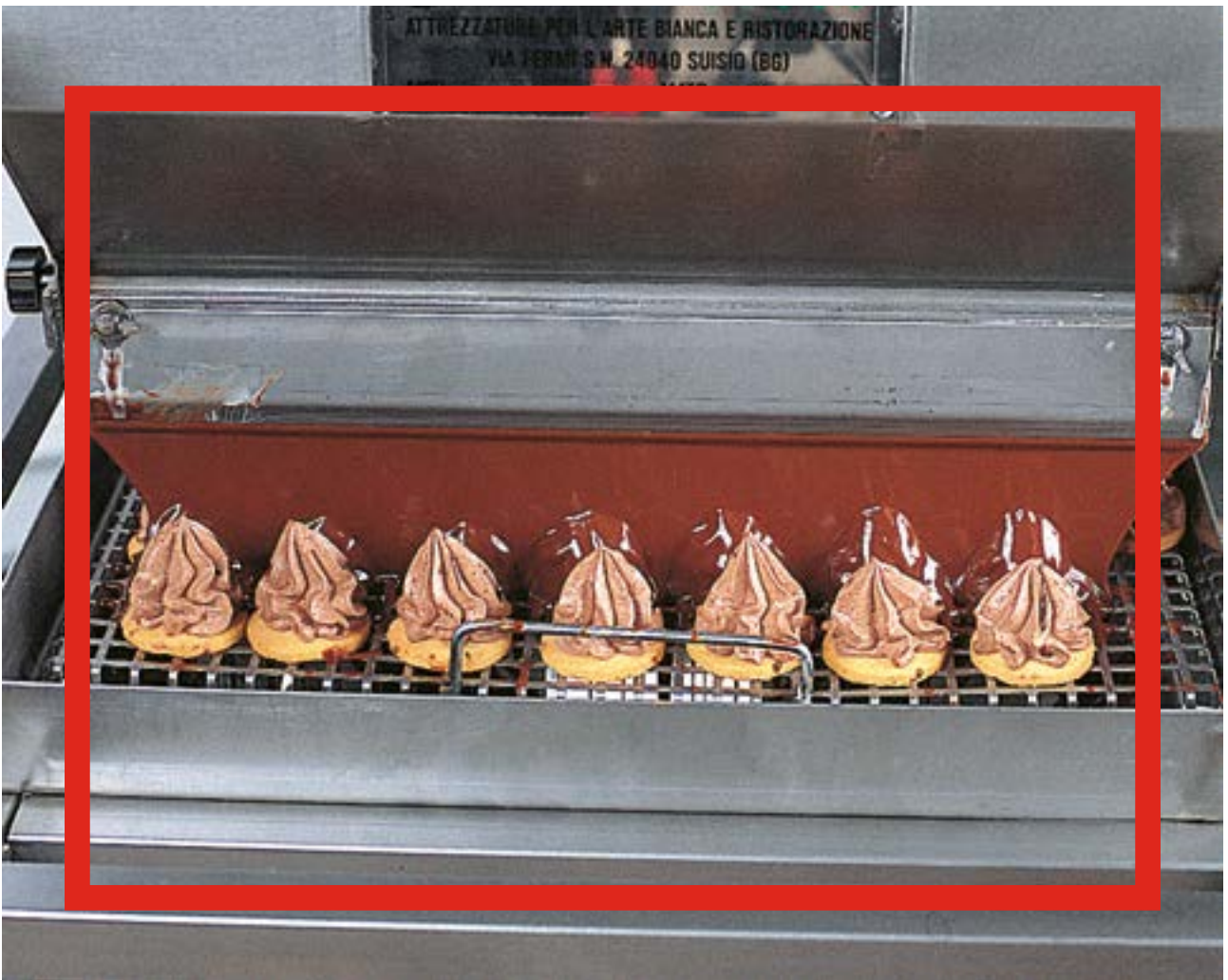



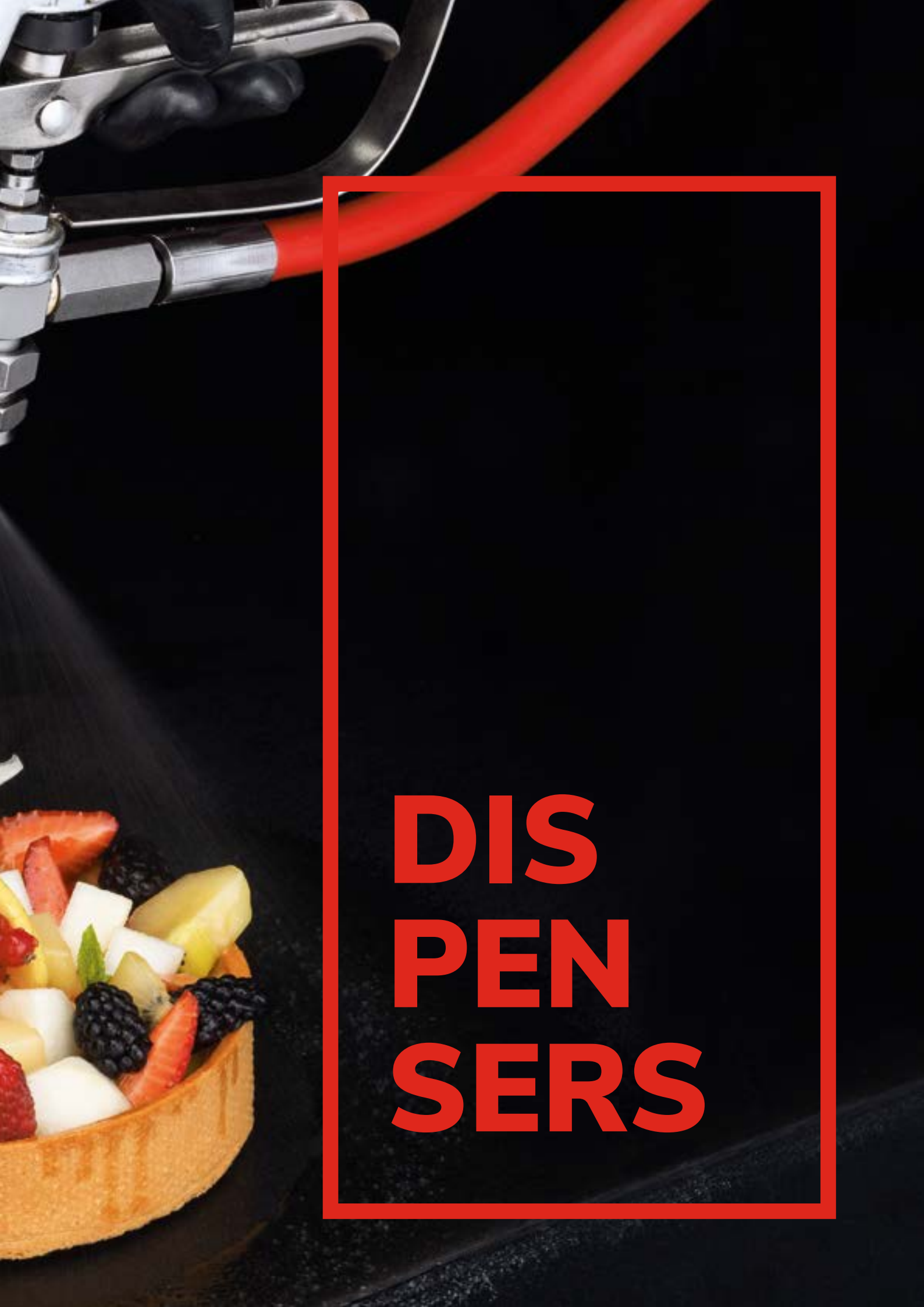

DIS PEN SERS

Spray Compact

Dimensioni ultracompatte senza rinunciare alla potenza e all'efficienza. Spray Compact distribuisce la gelatina uniformemente e, con ingombro minimo, è dotata di un compressore e una potente caldaia. Il risultato sono tempi di esecuzione ottimizzati e un risparmio sulla quantità di prodotto spruzzata. Temperatura e pressione sono regolabili mediante le apposite manopole. Utilizzabile con gelatina liquida a temperatura ambiente. Realizzata in acciaio inox. **2 anni di garanzia.**

Ultra-compact dimensions without sacrificing power and efficiency. Spray Compact distributes gelatine evenly and comes equipped with a compressor and a powerful boiler, all in a small package. The result is optimised running times and savings on the amount of product sprayed. Temperature and pressure are all fully adjustable by means of special knobs. Can be used with room temperature liquid glazes. Made of stainless steel.

2 year warranty.



Inclusi - Included

- Ugelli per cono Ø mm 40 e 80
Nozzle for cone Ø mm 40 and 80
- Ugello per crostate e torte di grandi dimensioni
Nozzle for large-sized tarts and cakes
- Imbuto più chiave per rabbocco acqua distillata nella caldaia
Funnel and wrench for topping up distilled water in boiler

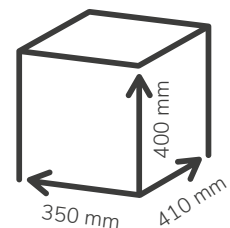

CODE	PESO WEIGHT (kg)	POTENZA ELETTRICA ELECTRICAL POWER (Watt)	TENSIONE ELETTRICA ELECTRICAL VOLTAGE (Volt-Hz)	CAPACITÀ DI EROGAZIONE DISPENSING CAPACITY (cc/min)	PRESSIONE DI EROGAZIONE DISPENSING PRESSURE (bar)	TEMP. DI ESERCIZIO WORKING TEMP. (°C)	POTENZA RISCALDANTE WARM POWER (Watt)
SPRAYCOMPACT	28	1600	230/240 - 50 * 110 - 60	350	3,7	fino a - up to 90	1500

* a richiesta
on demand

Spray Dynamic

Distribuzione del prodotto uniforme, risparmio di gelatina e bagna utilizzata, massima ottimizzazione dei tempi. Spray Dynamic è piccola nelle dimensioni ma capace di grandi prestazioni, grazie al compressore di cui è equipaggiata e alla potente caldaia ermetica: rapido riscaldamento dell'acqua con ridotti tempo di attesa e migliore risparmio energetico. La temperatura è regolabile tramite l'interfaccia elettronica. La pistola erogatrice può essere impiegata per spruzzare gelatine a caldo oppure liquidi freddi quali bagna e liquori.

Uniform distribution, more efficient use of gelatine and infusions, maximum time-saving. Spray Dynamic might be small in size, but it punches above its weight when it comes to performance thanks to the special compressor and the powerful sealed boiler system - the fast heating of the water reduces waiting times and guarantees considerable energy savings. The temperature is adjustable via electronic interface. The spray gun can be used to dispense hot gelatine or cold liquids such as infusions and liqueurs.

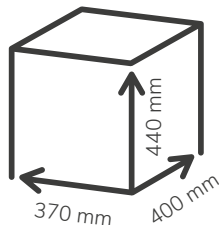

Inclusi - Included

- Ugelli per cono Ø mm 40 e 80
Nozzle for cone Ø mm 40 and 80
- Ugello per crostate e torte di grandi dimensioni
Nozzle for large-sized tarts and cakes
- Imbuto più chiave per rabbocco acqua distillata nella caldaia
Funnel and wrench for topping up distilled water in boiler

CODE	PESO WEIGHT (kg)	POTENZA ELETTRICA ELECTRICAL POWER (Watt)	TENSIONE ELETTRICA ELECTRICAL VOLTAGE (Volt-Hz)	CAPACITÀ DI EROGAZIONE DISPENSING CAPACITY (cc/min)	PRESSIONE DI EROGAZIONE DISPENSING PRESSURE (bar)	TEMP. DI ESERCIZIO WORKING TEMP. (°C)	POTENZA RISCALDANTE WARM POWER (Watt)
SPRAYDYNAMIC	32	1700	220/240 - 50 * 110 - 60	400	4	fino a - up to 90	1500

* a richiesta
on demand

Carrello in acciaio inox AISI 304

Stainless steel trolley AISI 304 Spray Compact - Dinamic

CODE	PESO WEIGHT (kg)	DIMENSION (mm)
CARSPRAY	14,5	420x400x830 h



Guarda il video dedicato a **Spray Dynamic** sul canale Youtube di Pavoni Italia
Watch the video "**Spray Dynamic**" on Pavoni Italia's Youtube channel

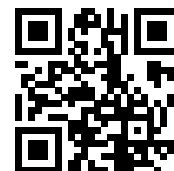

Spray Gel VPM

Per produzioni voluminose, Spray Gel VPM è la scelta giusta per efficienza e durata. Il grande vano posteriore permette di alloggiare il contenitore della gelatina all'interno della macchina, mentre la caldaia ermetica permette un rapido riscaldamento, accorciando i tempi di attesa, con conseguente risparmio energetico. Spray Gel VPM è dotata di innesto rapido ad aria compressa posto sul frontalino comandi ed è equipaggiata con un compressore più potente, utilizzabile con varie attrezzature: aerografo, pistola per cioccolato e tutti quegli utensili che necessitano di aria compressa. Scocca in acciaio inox per una pulizia facile e rapida. **2 anni di garanzia.**

For high-volume output, Spray Gel VPM is the right choice when it comes to efficiency and durability. The large rear compartment allows for the gelatine container to be housed inside the machine, while a sealed boiler system ensures rapid heating, which reduces waiting times and provides considerable energy savings. Spray Gel VPM features a push-fit compression fitting on the front panel and is equipped with a more powerful compressor that can be used with various equipment, such as an airbrush, chocolate gun and any compressed air tool. Stainless steel body for quick and easy cleaning. **2 year warranty.**



Inclusi - Included

- Ugelli per cono Ø mm 40 e 80
Nozzle for cone Ø mm 40 and 80
- Ugello per crostate e torte di grandi dimensioni
Nozzle for large-sized tarts and cakes
- Imbuto più chiave per rabbocco acqua distillata nella caldaia
Funnel and wrench for topping up distilled water in boiler

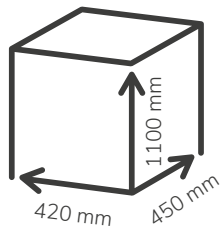

CODE	PESO WEIGHT (kg)	POTENZA ELETTRICA ELECTRICAL POWER (Watt)	TENSIONE ELETTRICA ELECTRICAL VOLTAGE (Volt-Hz)	CAPACITÀ DI EROGAZIONE DISPENSING CAPACITY (cc/min)	PRESSIONE DI EROGAZIONE DISPENSING PRESSURE (bar)	TEMP. DI ESERCIZIO WORKING TEMP. (°C)	POTENZA RISCALDANTE WARM POWER (Watt)
SPRAYGELVPM	72	2700	220/240- 50/60 * 110 - 60	450	da - from 2,8 a - up to 5	fino a - up to 90	2500

* a richiesta - on demand



Guarda il video dedicato a **Spray Gel VPM** sul canale Youtube di Pavoni Italia
Watch the video "**Spray Gel VPM**" on Pavoni Italia's Youtube channel

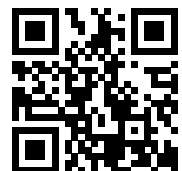

Spray Gel Twin C

Più produttiva con doppio utilizzo a caldo.
Dual use for hot spraying: more productivity.

Due erogatori per una grande produttività. Spray Gel Twin C è dotata di due circuiti separati e due pistole con tubi di aspirazione rossi per l'erogazione di gelatina: si possono così lavorare contemporaneamente prodotti diversi, erogando gelatine di differenti gusti. Caldaia ermetica a rapido riscaldamento per maggiore efficienza e minori consumi. L'aspirazione avviene direttamente dai contenitori posti nel vano inferiore e i prodotti vengono inviati agli erogatori direttamente senza il contatto con l'aria, per la massima igiene. La scocca, interamente in acciaio inox, permette una facile e rapida pulizia. **2 anni di garanzia.**

*Two dispensers deliver high productivity. Spray Gel Twin C is equipped with two separate circuits and two guns with red suction hoses for dispensing gelatine. This allows different-flavoured gelatines to be used and dispensed simultaneously. Sealed boiler with rapid heating for greater efficiency and lower energy consumption. The product is drawn directly from the containers placed in the lower compartment and sent to sprayers without coming into contact with the air, thus guaranteeing maximum hygiene. The entirely stainless steel body allows for quick and easy cleaning. **2 year warranty.***



Inclusi - Included

- Ugelli per cono Ø mm 40 e 80
Nozzle for cone Ø mm 40 and 80
- Ugello per crostate e torte di grandi dimensioni
Nozzle for large-sized tarts and cakes
- Imbuto più chiave per rabbocco acqua distillata nella caldaia
Funnel and wrench for topping up distilled water in boiler

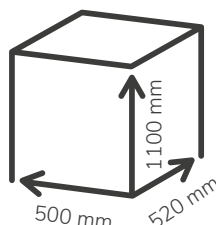

CODE	PESO WEIGHT (kg)	POTENZA ELETTRICA ELECTRICAL POWER (Watt)	TENSIONE ELETTRICA ELECTRICAL VOLTAGE (Volt-Hz)	CAPACITÀ DI EROGAZIONE DISPENSING CAPACITY (cc/min)	PRESSIONE DI EROGAZIONE DISPENSING PRESSURE (bar)	TEMP. DI ESERCIZIO WORKING TEMP. (°C)	POTENZA RISCALDANTE WARM POWER (Watt)	
SPRAYGELTWIN/C	80	3200	220/240 - 50 * 220/240 - 60	450	da - from 2,8 a - up to 5	fino a - up to 90	3000	* a richiesta on demand

Spray Gel Twin F

A caldo e a freddo: due macchine in una.
Hot and cold: two machines in one.

Bagna e gelatina, insieme per la massima efficacia ed efficienza possibili. Spray Gel Twin F eroga a caldo e a freddo: il prodotto gelatina è distribuito tramite il tubo rosso e la pistola posta sul lato destro, mentre la bagna o altri liquidi dalla pistola tramite tubo di aspirazione azzurro, collocato sul lato sinistro. L'aspirazione avviene direttamente dai contenitori posti nel vano inferiore e i prodotti vengono inviati agli erogatori direttamente senza il contatto con l'aria, per la massima igiene. Caldaia ermetica a rapido riscaldamento per maggiore efficienza e minori consumi. Scocca interamente in acciaio inox, per una facile e rapida pulizia. **2 anni di garanzia.**

*Infusions and gelatines come together for the maximum possible efficacy and efficiency. Spray Gel Twin F sprays at both hot and cold temperatures. The gelatine is distributed through the red hose attached to the gun on the right, while the infusions or other liquids are distributed via the gun attached to the blue suction hose on the left. The product is drawn directly from the containers placed in the lower compartment and sent to sprayers without coming into contact with the air, thus guaranteeing maximum hygiene. Sealed boiler with rapid heating for greater efficiency and lower energy consumption. The entirely stainless steel body allows for quick and easy cleaning. **2 year warranty.***



Inclusi - Included

- Ugelli per cono Ø mm 40 e 80
Nozzle for cone Ø mm 40 and 80
- Ugello per crostate e torte di grandi dimensioni
Nozzle for large-sized tarts and cakes
- Imbuto più chiave per rabbocco acqua distillata nella caldaia
Funnel and wrench for topping up distilled water in boiler

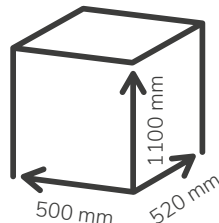

CODE	PESO WEIGHT (kg)	POTENZA ELETTRICA ELECTRICAL POWER (Watt)	TENSIONE ELETTRICA ELECTRICAL VOLTAGE (Volt-Hz)	CAPACITÀ DI EROGAZIONE DISPENSING CAPACITY (cc/min)	PRESSIONE DI EROGAZIONE DISPENSING PRESSURE (bar)	TEMP. DI ESERCIZIO WORKING TEMP. (°C)	POTENZA RISCALDANTE WARM POWER (Watt)	
SPRAYGELTWIN/F	80	3200	220/240 - 50 * 220/240 - 60	450	da - from 2,8 a - up to 5	fino a up to 90	3000	* a richiesta on demand

Ovospray

La soluzione specifica per spruzzare uovo, bagna, olio o staccante per stampi e teglie. Con Ovospray il preparato viene aspirato direttamente dal contenitore: la pressione dell'aria e del liquido sono poi regolati separatamente per ottenere un risultato sempre ottimale. Struttura e carrello di Ovospray sono realizzati in acciaio inox AISI 304. **2 anni di garanzia.**

The machine designed specifically for spraying egg, infusions, oil or pan- and mould-release agents. With Ovospray, the product is drawn directly from the container. The air and liquid pressure can be controlled separately to ensure perfect results. The body and trolley of Ovospray are made of AISI 304 stainless steel. **2 year warranty.**

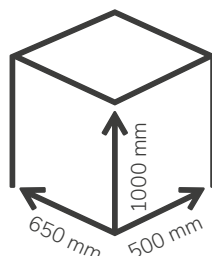

* a richiesta - on demand

CODE	PESO WEIGHT (kg)	DESCRIPTION	POTENZA ELETTRICA ELECTRICAL POWER (Watt)	TENSIONE ELETTRICA ELECTRICAL VOLTAGE (Volt-Hz)	CAPACITÀ DI EROGAZIONE DISPENSING CAPACITY (cc/min)	PRESSIONE DI EROGAZIONE DISPENSING PRESSURE (bar)	PRESSIONE DI ASPIRAZIONE INTAKE PRESSURE (bar)
OVOSPRAY	55	con compressore with compressor	1 hp 700	220/240 - 50/60 * 110 - 60	400	da - from 0,5 a - up to 4,5	da - from 0,5 a - up to 4,5
OVOSPRAY/SCOMP	35	senza compressore without compressor	1 hp 700	220/240 - 50/60 * 110 - 60	400	da - from 0,5 a - up to 4,5	da - from 0,5 a - up to 4,5



Guarda il video dedicato a **Ovospray** sul canale Youtube di Pavoni Italia
Watch the video "**Ovospray**" on Pavoni Italia's Youtube channel

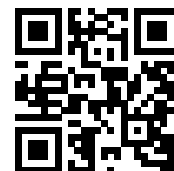

Ciocospritz

Una macchina pensata per nebulizzare il cioccolato temperato e i surrogati. Ciocospritz consente di regolare l'aria compressa e il prodotto con comandi separati per ottenere sempre un risultato ottimale. Il vano di apertura superiore rende semplice il caricamento di cioccolato sciolto temperato, che viene mantenuto in tempera da un sistema di riscaldamento. La temperatura è regolabile sino a 60°C. **2 anni di garanzia.**

*A machine designed to spray tempered chocolate and substitutes. Ciocospritz allows you to control the compressed air and product separately so you get perfect results every time. The upper opening compartment makes it easy to load tempered melted chocolate, which is then kept tempered by a heating system. The temperature is adjustable up to 60°C. **2 year warranty.***

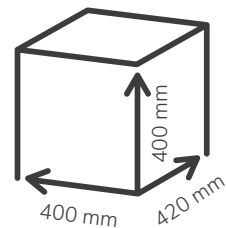

CODE	PESO WEIGHT (kg)	POTENZA ELETTRICA ELECTRICAL POWER (Watt)	TENSIONE ELETTRICA ELECTRICAL VOLTAGE (Volt-Hz)
CIOCOSPRITZ	24	250	220/240 - 50/60 * 110 - 60

* a richiesta - on demand



Guarda il video dedicato a **Ciocospritz** sul canale Youtube di Pavoni Italia
Watch the video "**Ciocospritz**" on Pavoni Italia's Youtube channel

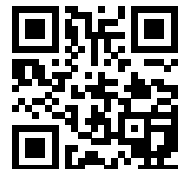

Accessori Ciocospritz - Ciocospritz accessories

Carrello in acciaio - Stainless steel trolley



CODE	PESO WEIGHT (kg)	DIMENSION (mm)
160100250	12,5	450x420x830 h

Compressore per Ciocospritz e Ovospray - Ciocospritz and Ovospray air compressor



CODE	PESO WEIGHT (kg)	CAPACITÀ CAPACITY (l)	DIMENSION (mm)	POTENZA ELETTRICA ELECTRICAL POWER (Hp-Watt)	TENSIONE ELETTRICA ELECTRICAL VOLTAGE (Volt-Hz)	PRESSIONE EROGAZIONE DISPENSING PRESSURE (bar-psi)
160100279	22	6	600x280x580 h	1 750	220/240 50	8 116





POWER MIX
professional



**PLA
NET
ARY**

**MIX
ERS**

Power Mix Professional

Impastatrice planetaria da banco formato 10 l. 10 l planetary bench mixer.

Potente, sicura, affidabile. Power Mix Professional ha un particolare sistema di ingranaggi, che consentono all'utensile di lavorare in 5 punti diversi della circonferenza della vasca al fine di ottenere un impasto omogeneo. Le operazioni di aggancio/sgancio degli utensili sono estremamente facilitate dall'ampia corsa della vasca. Il variatore elettronico regola con grande flessibilità la velocità di rotazione e allo stesso tempo con estrema precisione. La struttura è realizzata in acciaio inox AISI 304. **2 anni di garanzia.**

Powerful, safe, reliable. Power Mix Professional features a unique system of gears which allow the tool to work in 5 different points of the bowl circumference, giving you a perfectly homogeneous mixture. Tool attaching/detaching is made easy by the wide range of movement of the bowl. The electronic variator regulates the rotation speed with great flexibility and extreme precision. The body is made of AISI 304 stainless steel. **2 year warranty.**

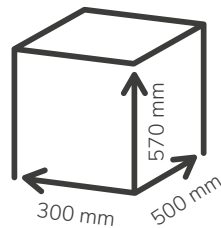

3 utensili in alluminio in dotazione
Supplied with 3 aluminium tools



Frusta
Whisk



Uncino
Hook



Spatola
Blade

Vasca supplementare a richiesta
Additional bowl available on request

CODE	PESO WEIGHT (kg)	POTENZA ELETTRICA ELECTRICAL POWER (Watt)	CAPACITÀ CAPACITY (l)	TENSIONE ELETTRICA ELECTRICAL VOLTAGE (Volt - Hz)	N° GIRI MINUTO REVOLUTION PER MINUTE
PMP	35	750	10	220/240 50/60	da - from 40 a - up to 160



Guarda il video dedicato a **Power Mix Professional** sul canale Youtube di Pavoni Italia

Watch the video "**Power Mix Professional**" on Pavoni Italia's Youtube channel



Pavomix

Tanta efficienza in poco spazio.
Big on efficiency, small on space.

La mescolatrice planetaria da banco Pavomix è una macchina professionale compatta e solida, realizzata in fusione di alluminio. È lo strumento di lavoro flessibile e ideale per qualsiasi cucina, luogo di ristorazione, gelaterie, laboratori di pasticcerie, panifici e pizzerie. Indispensabile per tutti gli operatori professionali che pretendono la praticità abbinata alla funzionalità e all'efficienza.

The Pavomix planetary bench mixer is a compact and solid professional machine made of cast aluminium. It is a flexible working tool and ideal for any kitchen, restaurant, ice cream shop, pastry shops, bakery and pizzeria. An essential piece of kit for any professional who desires practicality combined with functionality and efficiency.

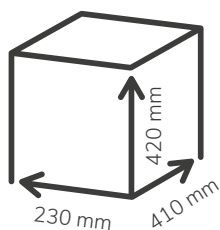

3 utensili in alluminio in dotazione
 Supplied with 3 aluminium tools



Frusta
Whisk



Gancio
Hook



Spatola
Blade

Vasca supplementare a richiesta
 Additional bowl available on request

CODE	PESO WEIGHT (kg)	POTENZA ELETTRICA ELECTRICAL POWER (Watt)	CAPACITÀ CAPACITY (l)	TENSIONE ELETTRICA ELECTRICAL VOLTAGE (Volt AC-Hz)	N° GIRI MINUTO REVOLUTION PER MINUTE
PAVOMIX	17	500	6,5	220/240 50/60	da - from 63 a - up to 235

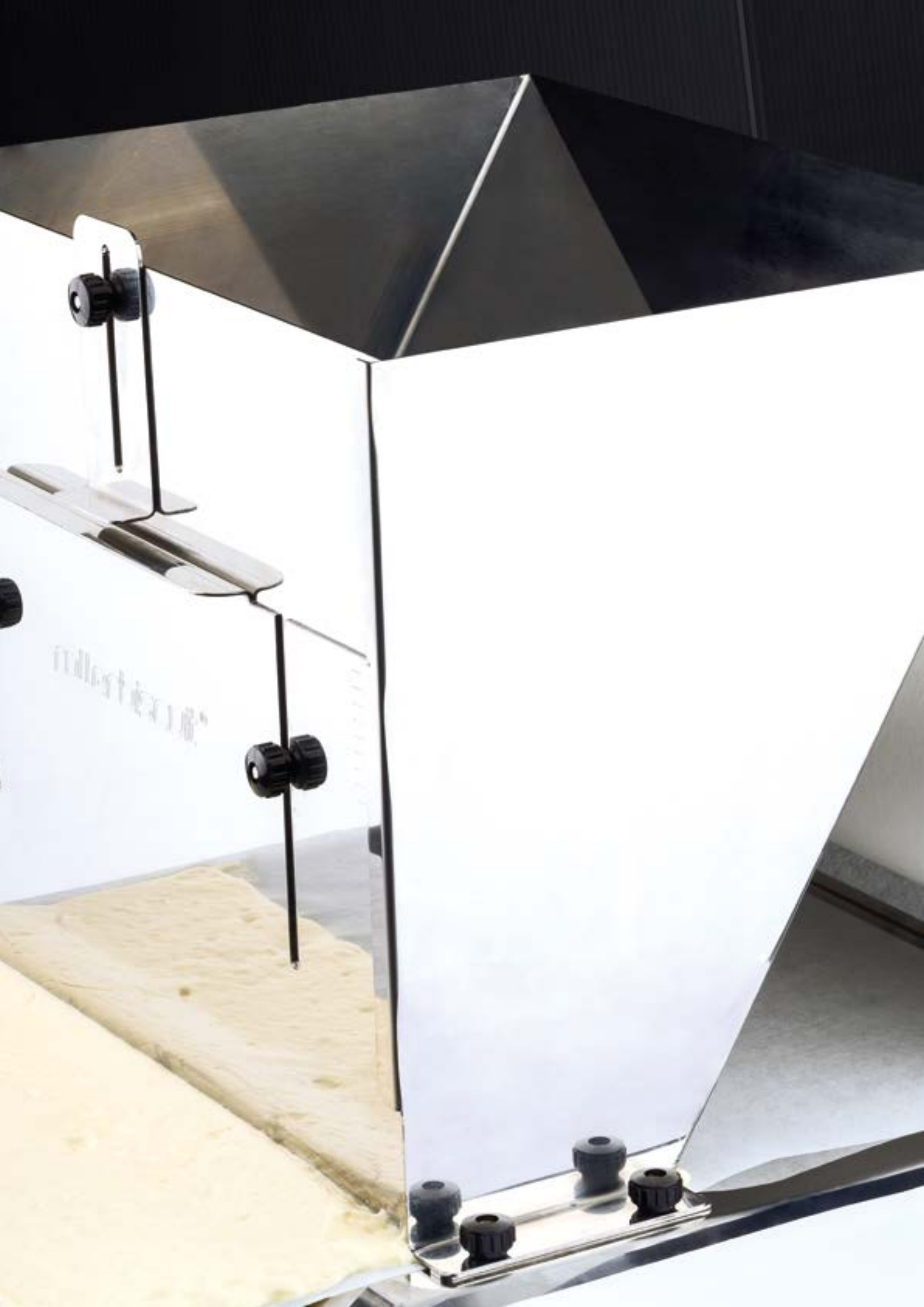



**OTH
ER**

**MA
CHI
NES**

Rollerbiscuit

Biscuit perfetti in altezza, in un quarto del tempo.
Perfectly-sized biscuits in a quarter of the time.

Rollerbiscuit è uno strumento studiato per permettere di stendere tutti i tipi di biscuit e masse di pari densità con velocità e precisione. La stesura del biscuit richiede circa 1/4 del tempo normalmente impiegato con il metodo tradizionale, con un prodotto qualitativamente superiore, di grande compattezza, regolare sia in altezza che in larghezza. Il funzionamento è totalmente meccanico: Rollerbiscuit dispone di tacche di regolazione per l'altezza del biscuit e di un regolatore centrale per memorizzare il livello selezionato. Si stendono biscuit adatti ad ogni tipo di utilizzo, ma soprattutto per la preparazione di mignon da taglio e di tronchetti. Rollerbiscuit è costruito interamente in acciaio inox, è facilmente smontabile e può essere lavato in lavastoviglie.

Rollerbiscuit is a tool designed to roll out all types of biscuits and doughs of equal density quickly and accurately. When compared to the traditional method of rolling out biscuit dough, Rollerbiscuit requires only 1/4 of the time normally used, while giving you a qualitatively superior product that is highly compact and uniform in terms of thickness and width. The operation is 100% mechanical: Rollerbiscuit is provided with adjustment notches for the biscuit thickness and a central regulator to save the selected level. It rolls out biscuits of all shapes and sizes, but it is particularly suited to those used in the preparation of mini-pastries and logs. Rollerbiscuit is made entirely of stainless steel, can be easily disassembled and is dishwasher safe.

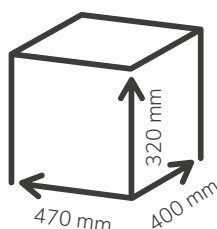

CODE	PESO WEIGHT (kg)
ROLLERBISCUIT	9

Accessori per Rollerbiscuit - Rollerbiscuit accessories



RR200

Rotolo di carta da forno
 Roll of baking paper

Dim mm 200x40



Cutter

Potenza gentile per granelle, salse e gelatine.
Gentle power for grinding, sauces and jellies.

La famiglia di Cutter è composta da solidi tritatutto per la preparazione di granella di nocciole, di mandorle tritate e per la lavorazione di moltissimi prodotti di normale utilizzo in laboratorio. Ottime anche per la preparazione di salse di frutta e verdura, gelatine di frutta e piccoli impasti.

The Cutter family is a series of grinders used to prepare ground hazelnut and chopped almonds, as well as the processing of many products normally used in the kitchen. The machines are excellent for preparing fruit or vegetable sauces, fruit jellies and small mixtures.



CODE	VELOCITÀ SPEED (g/m)	VASCA BOWL (l)	MOTORE ENGINE (hp)	DIMENSION (mm)
CUTTC4VV	1100-2600	3,5	0,5	380x320x270 h



CODE	VELOCITÀ SPEED (g/m)	VASCA BOWL (l)	MOTORE ENGINE (hp)	DIMENSION (mm)
CUTTC6VV	1100-2600	5,5	0,5	380x320x320 h



CODE	VELOCITÀ SPEED (g/m)	VASCA BOWL (l)	MOTORE ENGINE (hp)	DIMENSION (mm)
CUTTC9VV	1100-2600	9	0,5	470x330x400 h



CODE	VELOCITÀ SPEED (g/m)	VASCA BOWL (l)	MOTORE ENGINE (hp)	DIMENSION (mm)
CUTTC15DV	1400-2800	15	2,2+3 2 velocità - speed	420x445x1030 h

Accessori Accessories

Lame - Blades



Lama di serie
Standard blade



Lama a richiesta
Blade on request



Lama a richiesta
Blade on request

Tornados

Il comodo macinapane.
The convenient bread grinder.

Tornados è specifico per grattugiare pane secco, grissini e prodotti secchi da forno. La tramoggia è dotata di due paratie inclinate e disassate e di un microinterruttore rispondente alle attuali norme di sicurezza. Interamente in acciaio inox nelle parti a contatto con il pane. Dotato di 4 filtri per la scelta della granulometria. **2 anni di garanzia.**

*Tornados is specific for grating dry bread, breadsticks and dry baked goods. The hopper is equipped with two inclined and offset bulkheads and a microswitch that meets current safety standards. All parts that come into direct contact with the bread are made entirely of stainless steel. Equipped with 4 sieves for different crumb sizes. **2 year warranty.***

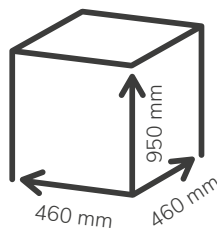

CODE	PESO WEIGHT (kg)	POTENZA ELETTRICA ELECTRICAL POWER (Watt)	TENSIONE ELETTRICA ELECTRICAL VOLTAGE (Volt-Hz)	MOTORE TRIFASE THREEPHASE MOTOR (hp)	PROD. ORARIA OUTPUT PER HOUR (kg/h)
TORNADOS	37	750	220/380 50/60	1	100/120

Superghibli

Macinatore per prodotti da forno.
Grinder for bakery products.

Superghibli frantuma e macina pane secco e prodotti secchi da forno. La tramoggia di carico, in acciaio inox come la camera di macinazione, è dotata di un cono di protezione per le norme antinfortunistiche. Dotato di tre filtri per la scelta della granulometria. **2 anni di garanzia.**

*Superghibli crushes and grinds dry bread and dry baked goods. The loading hopper and grinding chamber are made of stainless steel. The loading hopper is equipped with a safety cone for compliance with accident-prevention regulations. Equipped with three sieves for the choice of crumb size. **2 year warranty.***

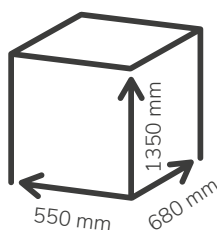

CODE	PESO WEIGHT (kg)	POTENZA ELETTRICA ELECTRICAL POWER (Watt)	TENSIONE ELETTRICA ELECTRICAL VOLTAGE (Volt AC-Hz)	MOTORE TRIFASE THREEPHASE MOTOR (hp)	PROD. ORARIA OUTPUT PER HOUR (kg/h)	Ø TRAMOGGIA HOPPER (mm)
SUPERGHIBLI	80	2200	220/380 50/60	3	250/300	600

Spiattina

Il catering fatto da professionisti.
Catering done by professionals.

Spiattina è la soluzione ideale per preparare e servire al momento ogni tipo di piatto. Permette di ottimizzare gli intervalli di tempo tra la preparazione dei piatti e il servizio in tavola, oltre a ridurre gli ingombri su carrelli portapiatti, tavoli, celle, etc. **2 anni di garanzia.**

*Spiattina is the ideal solution for preparing and serving any type of dish in an instant. Spiattina minimises the time between dish preparation and service at table, as well as reducing the quantity of items on trolleys, tables and food warmers, etc. **2 year warranty.***

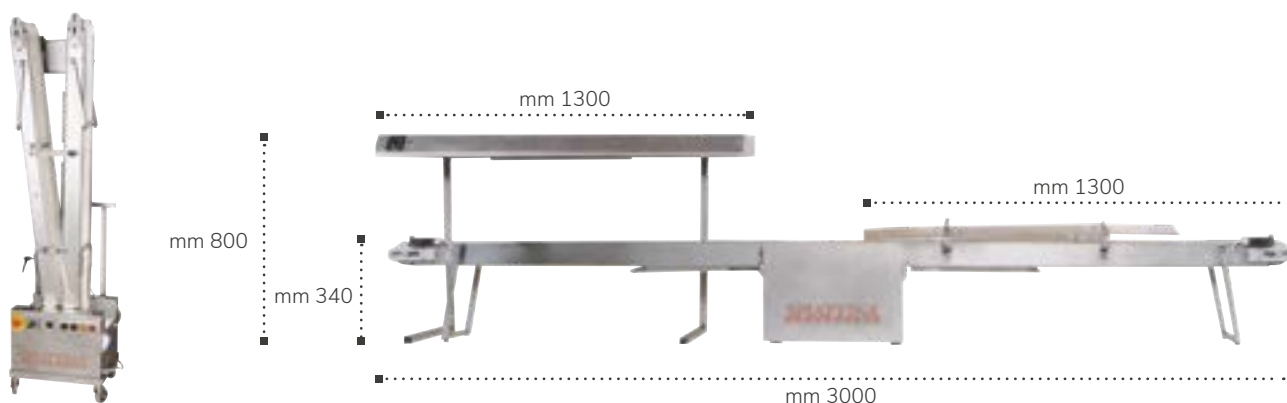

CODE	PESO WEIGHT (kg)	POTENZA ELETTRICA ELECTRICAL POWER (Watt)	TENSIONE ELETTRICA ELECTRICAL VOLTAGE (Volt AC-Hz)
SPIATTINA	70	150	220/240 - 50/60 *110 - 50/60

* a richiesta - on demand

Accessori - Accessories

Lampada - Lamp

CODE	PESO WEIGHT (kg)	POTENZA ELETTRICA ELECTRICAL POWER (Watt)	TENSIONE ELETTRICA ELECTRICAL VOLTAGE (Volt)	DIMENSION (mm)
LAMPADASPIATTINA	16	1200	220 volt	1300x400x150 h

Microonde

Microwave oven

Forni digitali programmabili.

Programmable digital ovens.

Tre diverse potenze e la massima versatilità: sono dotati di 20 memorie programmabili e 10 livelli di cottura. Interfaccia digitale, struttura in acciaio inox con piano in vetroceramica sigillato. Raffreddamento automatico dei componenti elettrici, sistema di distribuzione delle microonde ad antenna rotante e due magnetron per i modelli MASTER1400D e MASTER1800D.

It features three different wattages and maximum versatility – they are equipped with 20 programmable settings and 10 cooking power levels Digital interface, stainless steel body with a sealed glass-ceramic chamber base. Automatic cooling of electrical components, rotating antenna microwave distribution system with two magnetrons on the MASTER1400D and MASTER1800D models.

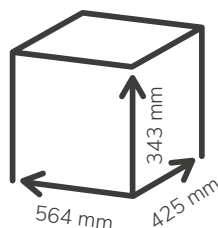

CODE	CAPACITÀ CAPACITY (l)	POTENZA ELETTRICA ELECTRICAL POWER (Watt)	TENSIONE ELETTRICA ELECTRICAL VOLTAGE (Volt)	DIM INTERNE INTERNAL DIM (mm)
MASTER1100D	17	1000	230 volt	330x305x175 h
MASTER1400D	17	1400	230 volt	330x305x175 h
MASTER1800D	17	1800	230 volt	330x305x175 h

Aladin

Lampada a infrarossi a due potenze selezionabili: 600 e 1200 W. Struttura e piano di lavoro in acciaio inox. Completamente smontabile. Cavo di alimentazione incluso.

Infrared lamp with two switchable powers: 600 and 1200 W. Stainless steel structure and working plan. Fully demontable. Power cable included.

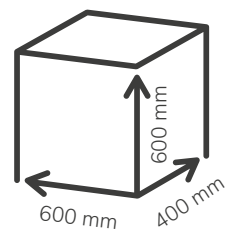

CODE	PIANO DI LAVORO WORKING PLAN (mm)	PESO WEIGHT (kg)
ALADIN	610x410	6

Lampada per zucchero

Artistic sugar lamp

Interamente in acciaio inox, completa di cassetto porta attrezzi, variatore di potenza e due resistenze porcellanane.

Completely stainless steel made, provided with drawer for tools, power variator and two porcelain resistances.

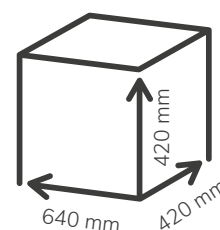
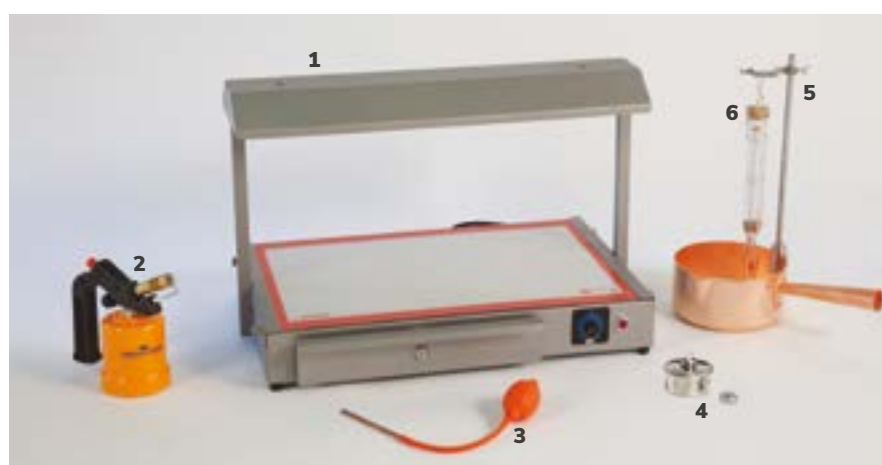

CODE	PESO WEIGHT (kg)	POTENZA ELETTRICA ELECTRICAL POWER (Watt)	TENSIONE ELETTRICA ELECTRICAL VOLTAGE (Volt)	PIANO DI LAVORO WORKING PLAN (mm)
1 LAMPADA	14	800	230	600x400

Accessori per Lampada per zucchero

Artistic sugar lamp accessories

CODE	DESCRIPTION	CODE	DESCRIPTION
2 CANNELLO	con accensione automatica torch with automatic ignition	5 RG1	reggi caramellometro holder for sugar thermometer
3 POMPETTA	con terminale in rame pump with copper terminal	6 CARAMELLOMETRO	con gabbia sugar thermometer with housing
4 BAZ	bocchetta alcool con stoppino stainless steel bottle with alcohol wick		





**COOK
MATIC**

**RECI
PES**

Cookmatic recipes

Tante ispirazioni per un impiego creativo ed entusiasmante delle macchine Cookmatic. Un ricettario realizzato con Yuri Cestari e dedicato ai professionisti, ricco di spunti e di consigli: tempi di cottura, suggerimenti e piccoli accorgimenti per utilizzare al meglio le macchine.

Lots of inspiration for more creative and exciting uses of Cookmatic machines. A cookbook made in conjunction with Yuri Cestari and dedicated to professionals, full of ideas and advice such as cooking times, suggestions and small tricks to help you get the most out of your machines.







Frolla neutra

Plain sweet shortcrust pastry

Ingredienti - Ingredients

400 g farina debole - soft flour 37,9%
 50 g fecola di patate - potato starch 4,7%
 50 g farina di riso - rice flour 4,7%
 300 g burro fresco - fresh butter 28,4%
 200 g zucchero semolato - caster sugar 18,9%
 55 g uova intere - eggs 5,2%
 1,5 g sale - salt 0,1%



12 g impasto crudo - raw dough

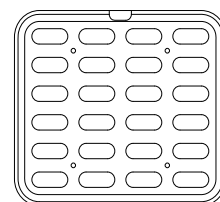

cod. **PIASTRA 39**



170°C



270 sec.

Procedimento - Instructions

Step 01

Portare il burro a 15°C circa.

Bring the butter to around 15°C.

Step 02

Mettere in planetaria la farina, la farina di riso e la fecola assieme al burro. Lavorare con la foglia fino ad ottenere un composto sabbioso, aggiungere lo zucchero e continuare ad impastare.

Pour the butter into a stand mixer, then add the flour, rice flour and the potato starch. Using the flat beater, work mixture until it has a sandy texture. Add the sugar and continue mixing.

Step 03

Inserire le uova con sciolto all'interno il sale ed impastare fino ad amalgamare il composto.

Add the salt to the eggs until dissolved, then add to the stand mixer and work until combined.

Step 04

Lasciare riposare la frolla in frigorifero per cristallizzare il grasso.

Let the dough rest in the fridge so the fat can crystallise.

Step 05

Plastificare in planetaria col gancio, formare della misura necessaria per la piastra e cuocere nella forma cuocitartellette.

Beat in the stand mixer with the hook and cook.



Frolla cacao 3%

3% cocoa sweet shortcrust pastry

Ingredienti - Ingredients

375 g farina debole - soft flour 35,9%
 50 g fecola di patate - potato starch 4,8%
 15 g cacao 22-24 - cocoa 22-24 1,4%
 300 g burro fresco - fresh butter 28,7%
 200 g zucchero semolato - caster sugar 19,1%
 50 g polvere di mandorle - almond flour 4,8%
 55 g uova intere - eggs 5,3%
 1 g sale - salt 0,1%

 30 g impasto crudo - raw dough

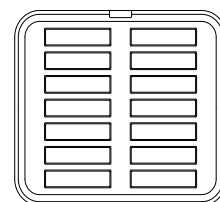

cod. **PIASTRA X**



180°C



330 sec.

Procedimento - Instructions

Step 01 Portare il burro a 15°C circa, mettere in planetaria con la farina, la fecola ed il cacao setacciati. Lavorare con la foglia fino ottenere un composto sabbioso.

Bring the butter to around 15°C. Pour the butter into a stand mixer and add the flour, potato starch and sieved chocolate. Using the flat beater, work mixture until it has a sandy texture.

Step 02 Aggiungere lo zucchero e la polvere di mandorle e continuare ad impastare.

Add the sugar and almond flour and continue working.

Step 03 Aggiungere infine le uova con sciolto il sale all'interno ed impastare il tempo necessario per amalgamare il composto.

Add the salt to the eggs until dissolved, then add to the stand mixer and work until combined.

Step 04 Lasciare riposare la frolla in frigorifero per cristallizzare il grasso.

Let the dough rest in the fridge so the fat can crystallise.

Step 05 Plastificare in planetaria col gancio, formare della misura necessaria per la piastra e cuocere nella forma cuocitartellette.

Beat in the stand mixer with the hook. Once finished, portion into appropriately-sized pieces for the plate.



Frolla cacao 8%

8% cocoa sweet shortcrust pastry

Ingredienti - Ingredients

350 g farina debole - soft flour 33,3%
 50 g fecola di patate - potato starch 4,8%
 30 g cacao 22-24 - cocoa 22-24 2,9%
 10 g cacao 10-12 (nero) - cocoa 10-12 (dark) 1,0%
 300 g burro fresco - fresh butter 28,6%
 200 g zucchero semolato - caster sugar 19,0%
 50 g polvere di mandorle - almond flour 4,8%
 60 g uova intere - eggs 5,7%



12 g impasto crudo - raw dough

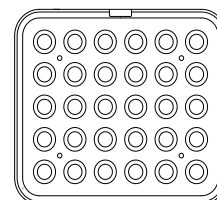

cod. **PIASTRA 2**



180°C



270 sec

Procedimento - Instructions

Step 01

Portare il burro a 15°C circa, mettere in planetaria con la farina, la fecola ed i 2 tipi di cacao setacciati. Lavorare con la foglia fino ottenere un composto sabbioso.

Bring the butter to around 15°C. Pour the butter into a stand mixer and add the flour, potato starch and two types of sieved chocolate. Using the flat beater, work mixture until it has a sandy texture.

Step 02

Aggiungere lo zucchero e la polvere di mandorle e continuare ad impastare.

Add the sugar and almond flour and continue working.

Step 03

Aggiungere infine le uova ed impastare il tempo necessario ad amalgamare il composto.

Add the egg and work until combined.

Step 04

Lasciare riposare la frolla in frigorifero per cristallizzare il grasso.

Let the dough rest in the fridge so the fat can crystallise.

Step 05

Plastificare in planetaria col gancio, formare della misura necessaria per la piastra e cuocere nella forma cuocitartellette.

Beat in the stand mixer with the hook. Once finished, portion into appropriately-sized pieces for the plate.



Frolla nocciola

Hazelnut sweet shortcrust pastry

Ingredienti - Ingredients

350 g farina debole - soft flour 28,4%
 75 g amido di mais - cornstarch 6,1%
 35 g pasta nocciola - hazelnut paste 2,8%
 265 g burro fresco - fresh butter 21,5%
 200 g zucchero a velo - icing sugar 16,2%
 225 g polvere di nocciole - hazelnut flour 18,3%
 80 g tuorlo - egg yolk 6,5%
 1 g sale - salt 0,1%



8 g impasto crudo - raw dough

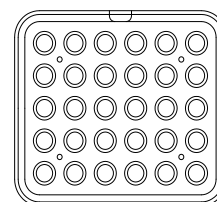

cod. **PIASTRA O**



170°C



270 sec

Procedimento - Instructions

Step 01

Portare il burro a 15°C circa ed aggiungere la pasta nocciola. Mettere in planetaria con la farina e l'amido e lavorare con la foglia fino ottenere un composto sabbioso.

Bring the butter to around 15°C and add the hazelnut paste. Add the butter mixture to the stand mixer and combine with the flour and cornstarch. Using the flat beater, work mixture until it has a sandy texture.

Step 02

Aggiungere lo zucchero a velo e la polvere di nocciola e continuare ad impastare.

Add the icing sugar and hazelnut flour and continue working.

Step 03

Aggiungere infine i tuorli con sciolto il sale all'interno ed impastare il tempo necessario per amalgamare il tutto.

Dissolve the salt in the egg yolks and add them to the mixture. Work until everything is combined.

Step 04

Lasciare riposare la frolla in frigorifero per cristallizzare il grasso.

Let the dough rest in the fridge so the fat can crystallise.

Step 05

Plastificare in planetaria col gancio, formare della misura necessaria per la piastra e cuocere nella forma cuocitartellette.

Beat in the stand mixer with the hook. Once finished, portion into appropriately-sized pieces for the plate.



Frolla alla panna

Sweet shortcrust pastry with single cream

Base bianca per colorazioni

White shortcrust pastry base for colouring

Ingredienti - Ingredients

900 g farina debole - soft flour 41,5%

100 g fecola di patate - potato starch 4,6%

100 g farina di riso - rice flour 4,6%

550 g burro fresco - fresh butter 25,3%

400 g zucchero semolato - caster sugar 18,4%

120 g panna fresca 35% - 35% fat fresh cream 5,5%



10 g impasto crudo - raw dough

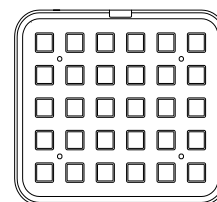

cod. **PIASTRA 10**



170°C



300 sec

Procedimento - Instructions

Step 01

Portare il burro a 15°C circa, mettere in planetaria con la farina, la farina di riso e la fecola. Lavorare con la foglia fino ottenere un composto sabbioso.

Bring the butter to around 15°C. Add the butter to the stand mixer and combine with the flour, rice flour and potato starch. Using the flat beater, work mixture until it has a sandy texture.

Step 02

Aggiungere lo zucchero e la polvere di mandorle e continuare ad impastare.

Add the sugar and the almond flour and continue working.

Step 03

Aggiungere infine la panna ed impastare il tempo necessario per amalgamare il composto.

Add the cream and work until combined.

Step 04

Dividere l'impasto e colorare a piacere con coloranti liposolubili.

Divide the mixture into portions and colour them with fat-soluble colours.

Step 05

Lasciare riposare la frolla in frigorifero per cristallizzare il grasso.

Let the dough rest in the fridge so the fat can crystallise.

Step 06

Plastificare in planetaria col gancio, formare della misura necessaria per la piastra e cuocere nella forma cuocitartellette.

Beat in the stand mixer with the hook. Once finished, portion into appropriately-sized pieces for the plate.

Frolla senza latticini

Lactose-free sweet shortcrust pastry

Ingredienti - Ingredients

400 g farina debole - soft flour 37,5%
 50 g fecola di patate - potato starch 4,7%
 50 g farina di riso - rice flour 4,7%
 300 g burro ricostruito* - recomposed butter* 28,1%
 200 g zucchero semolato - caster sugar 18,8%
 65 g uova intere - eggs 6,1%
 1,5 g sale - salt 0,1%

*Burro ricostruito - Recomposed butter

150 g tuorlo - egg yolk
 200 g burro di cacao - cocoa butter
 150 g olio di semi - seed oil
 150 g olio evo - extra virgin olive oil



30 g impasto crudo - raw dough

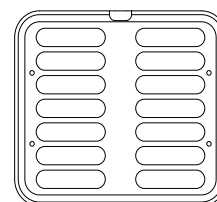

cod. **PIASTRA 38**



170°C



300 sec

Procedimento - Instructions

Step 01

Inserire nel cutter il tuorlo, aggiungere il burro di cacao a 35°C inserendolo a filo, aggiungere poi l'olio mantenuto in frigorifero (+4°C). Stabilizzare il prodotto in frigo prima di usare.

In the cutter, add the yolk and the 35°C cocoa butter slowly pour. Add the (+4°C) refrigerated oil. Refrigerate the product before using.

Step 02

Portare il burro ricostruito a 15°C circa, mettere in planetaria con la farina, la farina di riso e la fecola. Lavorare con la foglia fino ottenere un composto sabbioso.

Bring the butter to around 15°C. Add the butter to the stand mixer and combine with the flour, rice flour and potato starch. Using the flat beater, work mixture until it has a sandy texture.

Step 03

Aggiungere lo zucchero e continuare ad impastare.

Add the sugar and continue working.

**Step
04**

Aggiungere le uova con sciolto il sale all'interno ed impastare il tempo necessario per amalgamare il composto.

Dissolve the salt in the eggs and add to the mixture and work until combined.

**Step
05**

Lasciare riposare la frolla in frigorifero per cristallizzare il grasso.

Let the dough rest in the fridge so the fat can crystallise.

**Step
06**

Plasticare in planetaria col gancio, formare della misura necessaria per la piastra e cuocere nella forma cuocitartellette.

Beat in the stand mixer with the hook attachment. Once finished, portion into appropriately-sized pieces for the plate





Frolla vegana

Vegan sweet shortcrust pastry

Ingredienti - Ingredients

- 400 g farina debole - soft flour 37,7%
 50 g fecola di patate - potato starch 4,7%
 50 g polvere di mandorle - almond flour 4,7%
 300 g grasso vegetale non idrogenato - non-hydrogenated vegetable oil 28,3%
 200 g zucchero semolato - caster sugar 18,8%
 60 g acqua - water 5,7%
 1 g sale - salt 0,1%
 0,3 g curcuma - turmeric 0%



12 g impasto crudo - raw dough

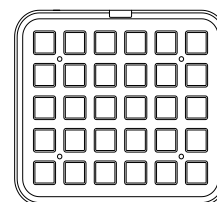

cod. **PIASTRA 3**



180°C

300 sec

Procedimento - Instructions

Step 01

Portare il grasso vegetale a 15°C circa, mettere in planetaria con la farina e la fecola. Lavorare con la foglia fino ottenere un composto sabbioso.

Bring the vegetable oil to around 15°C. Add the oil to the stand mixer, then combine with the flour and potato starch. Using the flat beater, work mixture until it has a sandy texture.

Step 02

Aggiungere lo zucchero e la polvere di mandorle, continuare ad impastare.

Add the sugar and the almond flour and continue working.

Step 03

Inserire l'acqua con sciolto all'interno il sale e la curcuma ed impastare fino ad ottenere il composto.

Dissolve the salt and turmeric in the water and add to the mixer. Continue working until combined.

Step 05

Lasciare riposare la frolla in frigorifero per cristallizzare il grasso.

Let the dough rest in the fridge so the fat can crystallise.

Step 06

Plastificare in planetaria col gancio, formare della misura necessaria per la piastra e cuocere nella forma cuocitartellette.

Beat in the stand mixer with the hook. Once finished, portion into appropriately-sized pieces for the plate.

Frolla senza glutine

Gluten-free sweet shortcrust pastry

Ingredienti - Ingredients

275 g farina di riso termotrattata - heat-treated rice flour 24,8%
 100 g fecola di patate - potato starch 9,0%
 100 g amido di mais - cornstarch 9,0%
 4 g xantano - xanthan gum 0,4%
 2 g farina di guar - guar seed flour 0,2%
 75 g polvere di mandorle - almond flour 6,8%
 300 g burro fresco - fresh butter 27,0%
 200 g zucchero vagliato medio - caster sugar 18,0%
 55 g uova intere - eggs 5,0%



10 g impasto crudo - raw dough

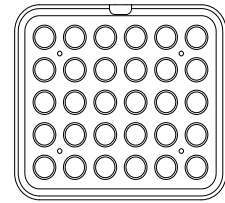

cod. **PIASTRA 52**



180°C



270 sec

Procedimento - Instructions

Step 01

Portare il burro a 15°C circa.

Bring the butter to around 15°C.

Step 02

Inserire nelle uova il mix di guar e xanato, miscelare col mixer ad immersione per disperderli.

Add the guar and the xanthan together and add to the eggs. Combine mixture with an immersion blender.

Step 03

Inserire in planetaria con foglio la farina di riso, l'amido di mais, la fecola di patate ed il burro. Lavorare con la foglia fino ad ottenere un composto sabbioso.

Put the rice flour, cornstarch, potato starch and butter in a stand mixer with flat beater. Using the flat beater, work mixture until it has a sandy texture.

Step 04

Aggiungere lo zucchero unito alla farina di mandorle e continuare ad impastare.

Combine the sugar and almond flour and work it into the mixture.

Step 05

Aggiungere infine il mix di uova e idrocolloidi ed impastare brevemente.

Add the mixture of eggs and hydrocolloids and work for a short time.

**Step
06**

Lasciare riposare la frolla in frigorifero per cristallizzare il grasso.

Let the dough rest in the fridge so the fat can crystallise.

**Step
07**

Plasticare in planetaria col gancio, formare della misura necessaria per la piastra e cuocere nella forma cuocitartellette.

Beat in the stand mixer with the hook. Once finished, portion into appropriately-sized pieces for the plate.





Pasta brisè

Shortcrust pastry

Ingredienti - Ingredienti

500 g farina debole - soft flour 54,6%
 300 g burro fresco - fresh butter 32,8%
 70 g acqua - water 7,7%
 10 g sale - salt 1,1%
 15 g zucchero semolato - caster sugar 1,6%
 20 g tuorlo - egg yolk 2,2%

 38 g impasto crudo - raw dough

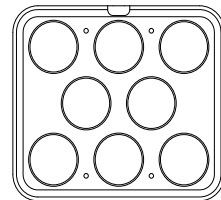

cod. **PIASTRA 45**



180°C



360 sec

Procedimento - Instructions

Step 01 Sciogliere il sale all'interno dell'acqua, aggiungervi i tuorli e mescolare.
 Dissolve the salt in the water, add the yolk and mix.

Step 02 Lavorare in planetaria la farina con il burro fino ad ottenere un composto sgranato.
 In the bowl of a stand mixer, combine the flour and butter until you have a grainy texture.

Step 03 Aggiungere il mix di liquidi ed impastare brevemente per non sollecitare la maglia glutinica.
 Add the liquid ingredients and mix briefly so as not to stress the gluten mesh.

Step 04 Lasciare riposare il prodotto in frigorifero.
 Let the dough rest in the fridge.

Step 05 Formare della misura desiderata per la piastra e cuocere nella forma cuocitartellette.
 Shape to the required size and cook.

Frolla salata

Savoury shortcrust pastry

Ingredienti - Ingredients

- 300 g burro fresco - fresh butter 28,7%
 1 g pepe - pepper 0,1%
 1 g noce moscata - nutmeg 0,1%
 375 g farina debole - soft flour 35,8%
 50 g fecola di patate - potato starch 4,8%
 75 g polvere di mandorla - almond flour 7,2%
 50 g trealosio - trehalose 4,8%
 50 g formaggio grana - parmesan cheese 4,8%
 100 g uova intere - eggs 9,6%
 40 g tuorlo - egg yolk 3,8%
 5 g sale - salt 0,5%



26 g impasto crudo - raw dough

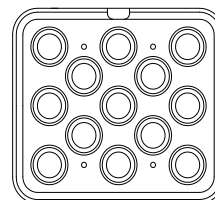

cod. **PIASTRA A**



170°C



300 sec

Procedimento - Instructions

Step 01

Portare il burro a 15°C circa, aggiungere il pepe e la noce moscata.

Bring the butter to around 15°C, then add the pepper and nutmeg

Step 02

Mettere in planetaria la farina e la fecola assieme al burro. Lavorare con la foglia fino ad ottenere un composto sabbioso.

Add butter to the stand mixer and combine with the flour and potato starch. Using the flat beater, work mixture until it has a sandy texture.

Step 03

Aggiungere il trealosio, la polvere di mandorle e il formaggio e continuare ad impastare.

Add the trehalose, almond flour and cheese and continue working.

Step 04

Inserire le uova, il tuorlo con sciolto all'interno il sale ed impastare fino ad amalgamare il composto.

Add the eggs, the egg yolk with dissolved salt and combine with mixture.

**Step
05**

Lasciare riposare la frolla in frigorifero per cristallizzare il grasso.

Let the dough rest in the fridge so the fat can crystallise.

**Step
06**

Plasticare in planetaria col gancio, formare della misura necessaria per la piastra e cuocere nella forma cuocitartellette.

Beat in the stand mixer with the hook. Once finished, portion into appropriately-sized pieces for the plate.





Tartelletta pera e caramello

Pear and caramel tartlets

Ingredienti cremoso - Caramel cream ingredients

200 g zucchero semolato - caster sugar 19,3%
50 g sciroppo di glucosio 60 de - 60 DE glucose syrup 4,8%
150 g latte fresco intero - fresh whole milk 14,5%
150 g tuorlo - egg yolk 14,5%
200 g latte fresco intero - fresh whole milk 19,3%
160 g burro fresco - fresh butter 15,5%
100 g burro di cacao - cocoa butter 9,7%
24 g massa di gelatina - gelatine mass 2,3%

Procedimento - Instructions

Step
01

Caramellare lo zucchero semolato.

Caramelize the caster sugar.

Step
02

Decuocere con il latte e il glucosio bollenti.

Combine with the boiling milk and glucose.

Step
03

Aggiungere il restante latte e il tuorlo e cuocere ad 85°C.

Add the remaining milk and the yolk and cook at 85°C.

Step
04

Aggiungere la massa di gelatina e versare sopra a burro e burro di cacao emulsionando con il pimer.

Add the gelatine mass and pour over butter and cocoa butter. Emulsify everything with the blender.

Step
05

Colare una parte di composto in stampi a semisfera e lasciare una parte in vaschetta.

Pour a part of the mixture into hemisphere moulds, place another part in a tray and set aside.

Step
06

Abbatte in negativo gli stampi in silicone e stoccare, mantenere in frigo la parte in vaschetta.

Blast chill the silicone moulds. Keep the part on the tray in the refrigerator.

Ingredienti gelificato di pera a cubetti - Diced gelled pear ingredients

330 g pere a dadini - diced pears 75,9%
 35 g zucchero - caster sugar 8,0%
 35 g zucchero - caster sugar 8,0%
 5 g pectina nh - NH Pectin 1,1%
 30 g massa di gelatina - gelatin mass 6,9%

Procedimento - Instructions

Step 01

Premiscelare le pere a dadini con la prima parte di zucchero, iniziare a cuocere così da far fuoriuscire la parte acquosa.

Pre-mix the diced pears with the first portion of sugar, then start cooking the pears to lose some of their water.

Step 02

A 50°C aggiungere il mix di zucchero e pectina e portare a bollire. Cuocere per 2-3 minuti fino a quando la pera non risulta leggermente morbida

At around 50°C add the mixture of sugar and pectin and bring it to the boil. Cook for 2-3 minutes until the pears are slightly soft.

Step 03

Aggiungere la gelatina reidratata.

Add the rehydrated gelatin.

Step 04

Versare in stampi in silicone a semisfera livellando bene con spatola.

Pour into silicone hemisphere moulds, levelling well with a spatula.

Step 05

Congelare e sformare.

Freeze and remove from the mould.

Composizione - How to compose

All'interno di una frolla al cacao già cotta mettere una base di cremoso al caramello precedentemente raffreddato in frigorifero. Posizionare sopra la semisfera di pere gelificate congelate. Scongelare il prodotto e decorare.

Put a base of previously fridged caramel cream inside one of the pre-cooked cocoa tartlettes. Put a base of caramel cream inside one of the pre-cooked cocoa tartlettes. Place over the hemisphere of frozen gelled pears. Unfreeze and decorate.

Tartelletta pralinata

Praline tartlet

Ingredienti crema inglese pralinata (base)

Praline crème anglaise ingredients (base)

1 kg latte pastorizzato intero - pasteurised whole milk 55,6%
 60 g zucchero semolato - caster sugar 3,3%
 250 g tuorlo - egg yolk 13,9%
 400 g pralinato nocciola liscio - smooth hazelnut praline 22,2%
 90 g massa di gelatina - gelatin mass 5,0%

Procedimento - Instructions

Step
01

Portare a bollire il latte con il pralinato.

Combine the milk and hazelnut praline in a pot and bring to the boil.

Step
02

A parte stemperare i tuorli con lo zucchero.

In another bowl, combine the sugar and the egg yolks.

Step
03

Quando il latte bolle versarne una parte sui tuorli, rimettere sulla fonte di calore e cuocere il prodotto fino a 85°C.

When the milk begins to boil, pour part of it over the egg yolk mixture, put back on heat and cook until it reaches 85°C.

Step
04

Togliere dalla fonte di calore, aggiungere la gelatina e dividere il composto per le realizzazioni successive.

Remove it from the heat and add the gelatin. Divide up mixture for the next steps.

Ingredienti cremoso nocciola latte

Hazelnut milk cream ingredients

800 g crema inglese base - crème anglaise base 64,0%
 400 g copertura latte 41% - milk chocolate coating (41%) 32,0%
 50 g burro di cacao - cocoa butter 4,0%

Procedimento - Instructions

Step
01

Versare la crema inglese ancora calda in caraffa sopra cioccolato e burro di cacao.

Pour the still-warm crème anglaise in a jug over the chocolate and cocoa butter.

Step
02
Emulsionare con un mixer a lame.
Emulsify with a blade mixer.

Step
03
Versare in un contenitore e stabilizzare a 4°C.
Pour into a container and chill to 4°C.

Ingredienti bavarese bianca alla nocciola **Hazelnut bavarian cream ingredients**

800 g crema inglese base - crème anglaise base 41,5%

400 g copertura bianca 35% - white chocolate coating (35%) 20,7%

100 g burro di cacao - cocoa butter 5,2%

30 g massa di gelatina - gelatin mass 1,6%

600 g panna fresca 35% - fresh cream (35% fat) 31,1%

Procedimento - Instructions

Step
01
Versare la crema inglese ancora calda sopra il mix di gelatina, cioccolato bianco e burro di cacao in gocce.

Pour the still-warm crème anglaise over a mix of the gelatin, white chocolate and cocoa butter drops.

Step
02
Emulsionare con l'aiuto di un mixer a lame.
Emulsify with a blade mixer.

Step
03
Raffreddare a 30°C ed aggiungere la panna semimontata.
Cool the mixture to 30°C and add the semi-whipped cream.

Step
04
Colare negli stampi a semisfera ed abbattere in negativo per sformare.
Pour into the hemisphere moulds; blast chill to remove from the mould.

Composizione - How to compose

All'interno di tartellette di frolla alla nocciola mettere alla base di cremoso cioccolato al latte stabilizzato in frigorifero (temperatura ideale di colaggio 40°C) smodellare le semisfere di bavarese, spruzzare con effetto velluto e posizionarle sopra al cremoso sulla tartelletta.

Inside the hazelnut sweet shortcrust pastry, pour on the bottom the refrigerated milk chocolate cream (40°C is the ideal pouring temperature). Remove the hemisphere of Bavarian cream, spray them to create a velvet effect and place on the tartlette.



Un contributo essenziale. Il nostro grazie a:
A key support. Our thanks to:



La nostra ispirazione. Uno speciale ringraziamento a:
Our inspiration. A special thanks to:



Antonio
Bachour





Stefano
Laghi



Yuri
Cestari

Indice alfabetico - Alphabetic index

CODE	PAG	CODE	PAG	CODE	PAG
1099040	32	FS2739	36	PIASTRA 9	14
1099044	33	FS2740	36	PIASTRA 10	18
160100250	63	FS2760	36	PIASTRA 12	16
160100279	63	FS3000	34	PIASTRA 13	16
ALADIN	78	FS3271	33	PIASTRA 14	22
BCD/I	45	FS3305	35	PIASTRA 15	15
CARCOOK	25	GLASS-ICE	52	PIASTRA 18	18
CARRELLO LIRA	43	GT8	33	PIASTRA 19	18
CARSPRAY	57	GT15	32	PIASTRA 21	16
CCH	47	LAMPADA	79	PIASTRA 22	17
CHITARRA	44	LAMPADASPIATTINA	76	PIASTRA 24	16
CIOCOSPRITZ	62	LIRA/E	40	PIASTRA 26	15
COOKMATICMAXI 	26	LIRA/M	42	PIASTRA 27	19
CUTTTC4VV	72	LT05H6	43	PIASTRA 29	16
CUTTTC6VV	72	LT10H6	43	PIASTRA 34	19
CUTTTC9VV	73	LT15H6	43	PIASTRA 35	19
CUTTTC15DV	73	LT20H6	43	PIASTRA 38	14
DISCO PER TRAMOGGIA	33	LT25H6	43	PIASTRA 39	14
DOSIEMME	37	LT30H6	43	PIASTRA 41	17
DOSIMINI	37	LT35H6	43	PIASTRA 42	15
DOSIPLUSPRO	30	LT40H6	43	PIASTRA 45	17
F2418	36	LT45H6	43	PIASTRA 46	15
F2741	35	LT50H6	43	PIASTRA 52	15
F2861	36	LT60H6	43	PIASTRA 56	16
F2887	36	MASTER1100D	77	PIASTRA 57	16
F3011	35	MASTER1400D	77	PIASTRA 59	20
F3013	35	MASTER1800D	77	PIASTRA 60	20
F3014	35	MAXI38	27	PIASTRA A	20
F3042	34	MAXI45	27	PIASTRA B	20
F3055	34	MAXIW	27	PIASTRA C	21
F3064	35	MINITEMPER	50	PIASTRA D	15
F3066	35	NEWCOOKMATICPAV 	12	PIASTRA E	21
F3067	34	NEWCOOKMATICSPCIAL 	23	PIASTRA F	21
F3071	35	OVOSPRAY	61	PIASTRA G	20
F3076	35	OVOSPRAY/SCOMP	61	PIASTRA H	20
F3081	35	P3026	34	PIASTRA K	22
F3090	34	PAVOMIX	67	PIASTRA L	19
F3091	34	PB12	35	PIASTRA N	21
F3094	34	PB24	35	PIASTRA O	15
F3095	34	PIASTRA 00	22	PIASTRA P	19
F3097	34	PIASTRA 1	20	PIASTRA Q	18
F3101	34	PIASTRA 2	15	PIASTRA R	22
F3141	36	PIASTRA 3	19	PIASTRA S	17
F3147	36	PIASTRA 4	18	PIASTRA S03	24
F3187	36	PIASTRA 5	21	PIASTRA S04	24
F3212	34	PIASTRA 6	21	PIASTRA S05	24
F3339	34	PIASTRA 8	22	PIASTRA T	17

CODE	PAG
PIASTRA U	19
PIASTRA UM	19
PIASTRA V	17
PIASTRA W	16
PIASTRA X	18
PIASTRA Y	21
PIASTRA Z	17
PMP	66
QG3	47
QG5	47
QG10	47
QG15	47
ROLLERBISCUIT	70
RR200	70
SPIATTINA	76
SPRAYCOMPACT	56
SPRAYDYNAMIC	57
SPRAYGELTWIN/C	59
SPRAYGELTWIN/F	60
SPRAYGELVPM	58
SUPERGHIBLI	75
TCH7.5	47
TCH15	47
TCH22.5	47
TCH30	47
TCH37.5	47
TORNADOS	74

▣ Nuovi prodotti
New products

Le fotografie del presente catalogo non sono impegnative. I pesi e le misure possono essere soggetti a variazioni.

The pictures in this catalogue are not binding. Weights and measurements may be subject to variations.



Pavoni Italia S.p.a.

Via E. Fermi, s.n. - 24040 Suisio (BG) - Italia
T. +39 035 4934111 - F. +39 035 4948200
info@pavonitalia.com - www.pavonitalia.com



Management
System
ISO 9001:2015



www.tuv.com
ID 9105056998