

em
YOUR PIZZA HUB



VOLTAIRE

FORNO A GAS | *GAS OVEN*

**LE TUE PIZZE DA 30 A 45 CM DI Ø
PRONTE PER ESSERE SFORNATE
IN 3 MINUTI.**

***GET YOUR 30 TO 40 CM Ø PIZZAS
OUT OF THE OVEN
IN 3 MINUTES.***



Il forno a gas monocamera per pizze croccanti come cotte a legna.

The single chamber gas oven makes pizzas as crispy as if they were baked into a wood oven.

FORNO A LEGNA / WOOD OVEN

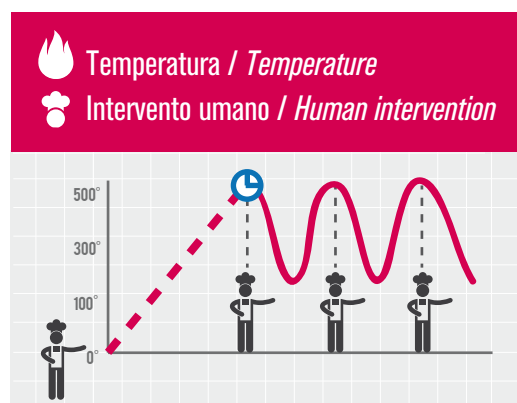

FORNO A GAS / GAS OVEN

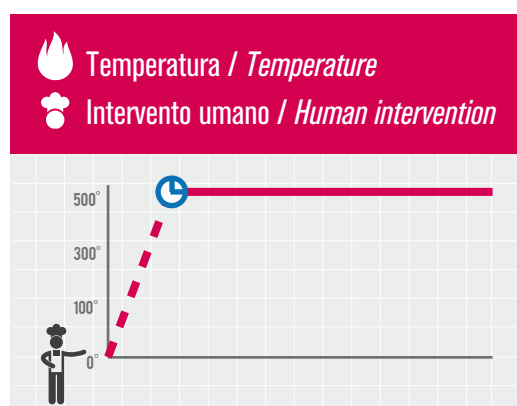

Voltaire è il forno monocamera alimentato con ogni tipo di gas (LPG, Propano liquido, gas Metano, ecc.), che ti consente di sfornare in 3 minuti pizze croccanti come quelle cotte a legna, ma senza il rischio di microrganismi, eccessi di umidità e bruciature. La cottura è più economica e uniforme, grazie ai **bruciatori superiori a infrarossi** che assicurano la **temperatura ottimale** alla farcitura, mentre la **piastra refrattaria** ad alto spessore ti consente di **cuocere direttamente a mattone**.

A parità di dimensioni camera (130x113 cm), Voltaire garantisce una **produttività più elevata** grazie all'ottimo isolamento ed al ripristino più veloce della temperatura, senza immissione di sostanze nocive nell'atmosfera.

Inoltre, grazie ai bruciatori superiori e inferiori regolabili in modo differenziato, **ottimizza la distribuzione del calore** e i consumi in funzione della potenza impostata, dimostrandosi una soluzione competitiva anche rispetto ai forni elettrici.

*Voltaire is a single chamber oven functioning with every type of gas (LPG, liquid Propane, Methane gas, etc.). It makes pizzas as crispy as if they were baked into a wood oven, but without the risk of microorganisms, burning and excess of humidity. The baking is economical and uniform, thanks to the **upper infra-red burners** which grant an **ideal temperature** for the toppings, and the **refractory high thickness** griddle allows to bake directly on the stone. In comparison with chambers of the same dimensions (130x113 cm), Voltaire grants a **higher productivity** thanks to its thick insulation layer and faster temperature recovery, without any emission of harmful particles. Moreover, due to lower and upper adjustable burners, the heat **distribution** and the consumptions related to set power are **optimized**, proving to be a competitive solution even compared to the electric ovens.*

**LA CAMERA DI COTTURA TI LASCERÀ
A BOCCA APERTA CON LA SUA EFFICIENZA.**

***THE BAKING CHAMBER WILL AMAZE YOU
WITH ITS EFFICIENCY.***

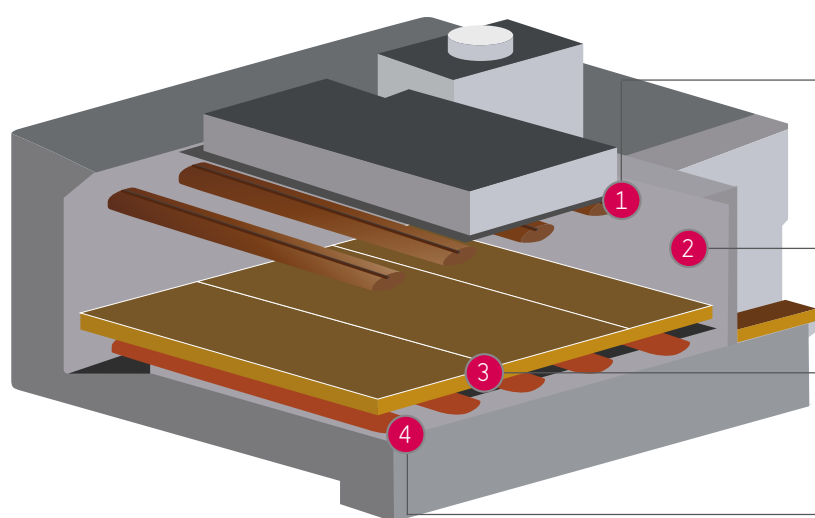

Bruciatori superiori a raggi infrarossi
con piastrine ceramiche
*Infrared upper burners
with a ceramic connection link*

Riscaldamento laterale camera
derivante dal recupero del calore
*The chamber side walls are heated
by the recycled heat*

Piano cottura a struttura alveolare
di alto spessore (4cm)
*Baking surface made with a beehive
structure of big thickness (4cm)*

Bruciatori inferiori atmosferici
Atmospheric inferior gas burner

PULITO / CLEAN

FACILE / EASY

SICURO / SAFE



Cottura uniforme e pulita
*Homogeneous baking
and cleanliness*



Ripristino veloce della temperatura
Fast temperature recovery



Produttività elevata
High production

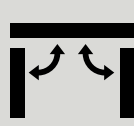

Forte risparmio energetico grazie
al recupero laterale del calore
*High energy saving due
to side recovery of the heat*



PRODUTTIVITÀ MEDIA ORARIA / *AVERAGE HOURLY OUTPUT*



140 Pizze Ø30

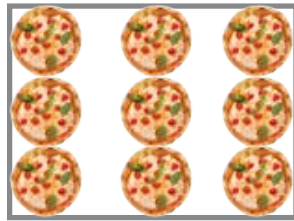

100 Pizze Ø35



45 Pizze Ø45



25 Teglie 60x40

KW / VOLT POTENZA TERMICA / *THERMIC POWER*

METANO

0,1 / 220 / 240
220 1N 50-60* **21 - 35**

GPL

0,1 / 220 / 240
220 1n 50-60* **24,5 - 35**

ACCESSORI / *ACCESSORIES*

Il forno viene fornito con supporto (regolabile in altezza max. 27,5 cm) o cella neutra, entrambi dotati di ruote (2 anteriori con freno).

The oven is supplied with a support (adjustable height max. cm 27,5) or a neutral chamber, both equipped with wheels (2 front wheels with brakes).

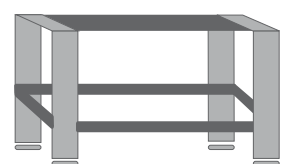
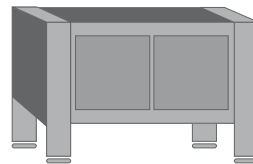

**INSERIMENTO PERFETTO
IN OGNI CONTESTO DI ARREDO.**

***PERFECT TO BE INCLUDED
IN EVERY CONTEXT.***





VOLTAIRE DA INCASSO: IL GUSTO PRENDE FORMA.

BUILT-IN VOLTAIRE: THE SHAPE OF TASTE.

Nella versione da incasso Voltaire viene fornito “nudo” per adattarsi alle esigenze di stile dei nuovi esercizi commerciali: puoi incassarlo alla perfezione con semplici opere murarie. Tutta la manutenzione (ordinaria e straordinaria) avviene sulla parte frontale per semplificare al massimo le operazioni e non compromettere il design dei locali. Con la sua straordinaria semplicità si colloca perfettamente in qualsiasi contesto d'arredo.

In its built-in version, Voltaire is supplied “naked” in order to fit the needs of shops and restaurants: you can assemble it in with simple building work. All the maintenance (ordinary and extraordinary) is carried out from the front, so any operation is simple and the design of the location isn't compromised. With its extraordinary easiness it fits perfectly in every context.



INCASSATO / BUILT - IN OVEN

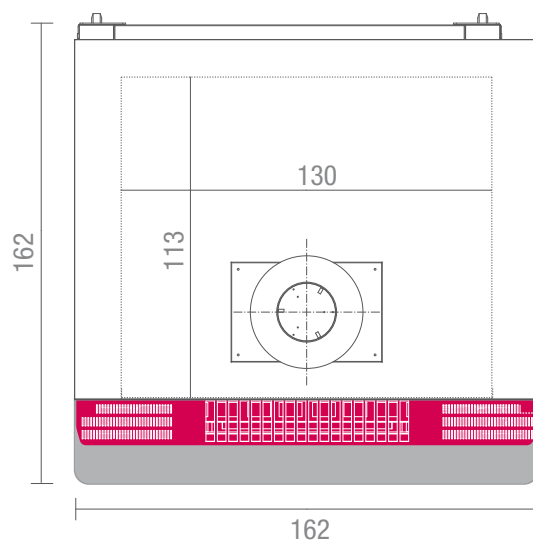

PESO E DIMENSIONI | *WEIGHT AND DIMENSIONS*

480 / 510kg - 162 X 162 X 78,5 cm (+65)

PANNELLO DI CONTROLLO | *CONTROL PANEL*



Termostato - termometro / *Thermostat - thermometer*

Manopola bruciatori volta / *Top burners knob*

Manopola bruciatori platea / *Bottom burners knob*

Manopola Accensione - Spegnimento forno
 Accensione illuminazione - Accensione pilota
Switch on knob - Oven switch off
Lighting switch on - Pilot switch on

SOLUZIONI D'INCASSO / *BUILT IN SOLUTIONS*

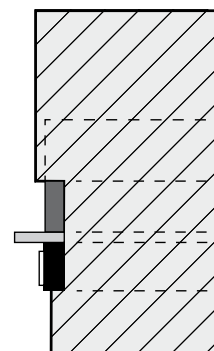
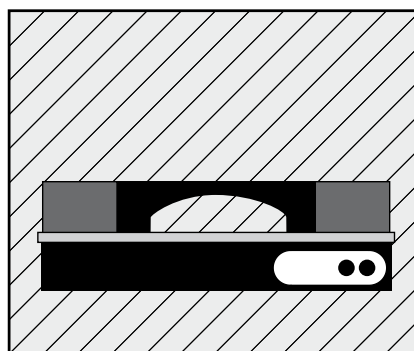
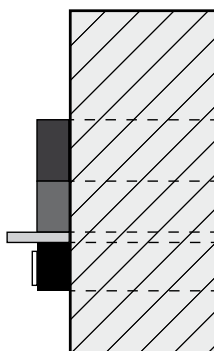
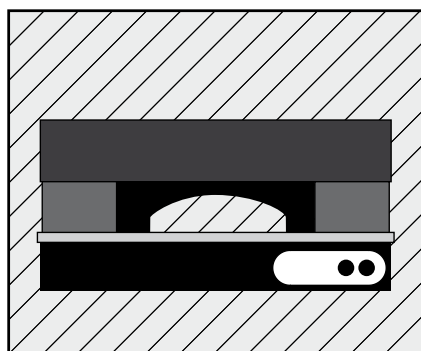

**COTTURE UNIFORMI CON BRUCIATORI
A REGOLAZIONE INDIPENDENTE CIELO/PLATEA.**

***UNIFORM BAKING WITH TOP/BOTTOM
INDEPENDENT REGULATION OF THE BURNERS.***





PEZZI DI PIZZE A PREZZI PAZZI!

MENU BUSINESS LUNCH	MENU	MARZO 5,50 panino, mortadella, salame	GIUGNO 5,50 panino, mortadella, salame
PIZZA 4,50 panino, mortadella, salame	PIZZA 4,50 panino, mortadella, salame	GIUGNO 5,50 panino, mortadella, salame	GIUGNO 5,50 panino, mortadella, salame
PIZZA 4,50 panino, mortadella, salame	PIZZA 4,50 panino, mortadella, salame	GIUGNO 5,50 panino, mortadella, salame	GIUGNO 5,50 panino, mortadella, salame
PIZZA 4,50 panino, mortadella, salame	PIZZA 4,50 panino, mortadella, salame	GIUGNO 5,50 panino, mortadella, salame	GIUGNO 5,50 panino, mortadella, salame
PIZZA 4,50 panino, mortadella, salame	PIZZA 4,50 panino, mortadella, salame	GIUGNO 5,50 panino, mortadella, salame	GIUGNO 5,50 panino, mortadella, salame

**CLASSICO, MODERNO,
TRADIZIONALE:
A CIASCUNO
IL SUO MODELLO.**

***CLASSIC, MODERN,
TRADITIONAL:
THE RIGHT MODEL
FOR EVERY ONE.***

Voltaire viene proposto anche in quattro diverse soluzioni di stile per adattarsi facilmente ad ogni tipologia di locale: Classico, Pompei, Ravenna e Ravenna a Mosaico. Stile moderno o tradizionale? Scegli la semplice essenzialità della versione classica o le forme morbide di Ravenna e adatta il colore al tuo arredo: sia le verniciature che il mosaico sono garantiti per l'utilizzo ad alte temperature.

Voltaire has three different solutions to fit easily every type of context: Classic, Ravenna and Ravenna with tiles. Modern style or traditional one? Choose the simplicity of the classic version or the smooth shapes of Ravenna and match the colours to your fittings: both the painting and the tiles are resistant to high temperatures.

CLASSICO / CLASSIC



PESO E DIMENSIONI | *WEIGHT AND DIMENSIONS*
480 /510kg - 162 X 162 X 78,5 cm (+65)

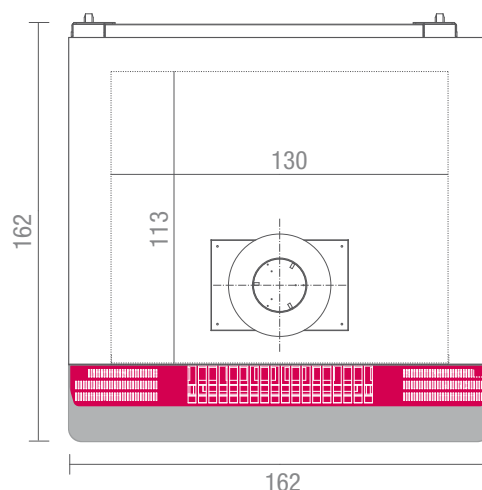

COLORI | *COLOURS*



NCS 4502 R



MG 7145



MG 7440



MR 3335



NCS 455 Y80R



MO 1110

RAVENNA

RAVENNA MOSAICO / MOSAIC



PESO E DIMENSIONI | WEIGHT AND DIMENSIONS

480 / 510kg - 162 X 183 X 78,5 cm (+65)

PESO E DIMENSIONI | WEIGHT AND DIMENSIONS

480 / 510kg - 162 X 183 X 78,5 cm (+65)

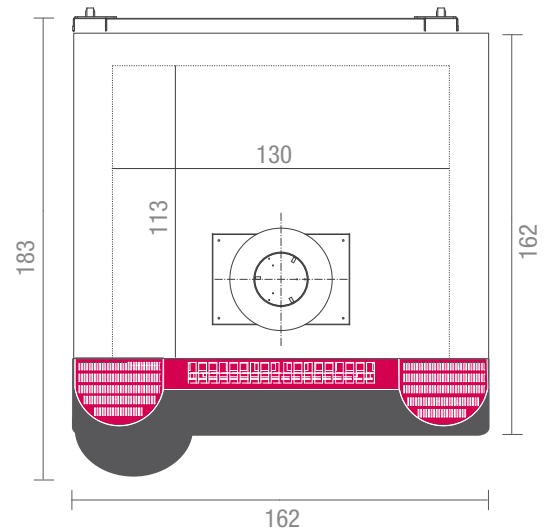
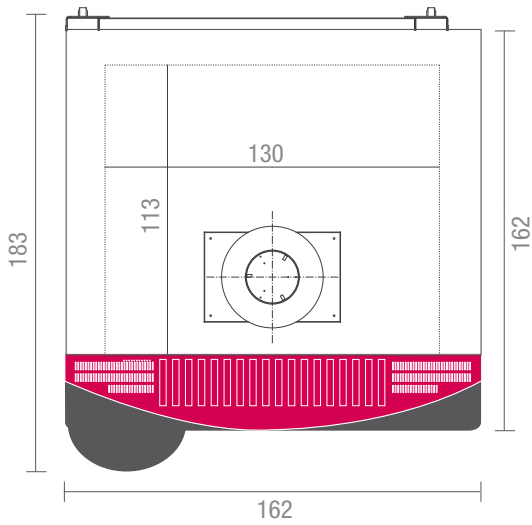

NCS 4502 R



MG 7145



MG 7440



MR 3335



NCS 455 Y80R



MO 1110



MOSAICO RUBINO
RUBY MOSAIC



MOSAICO GIALLO
YELLOW MOSAIC



MOSAICO GRIGIO
GREY MOSAIC



NCS 4502 R



MG 7145



MG 7440



MR 3335



NCS 455 Y80R



MO 1110

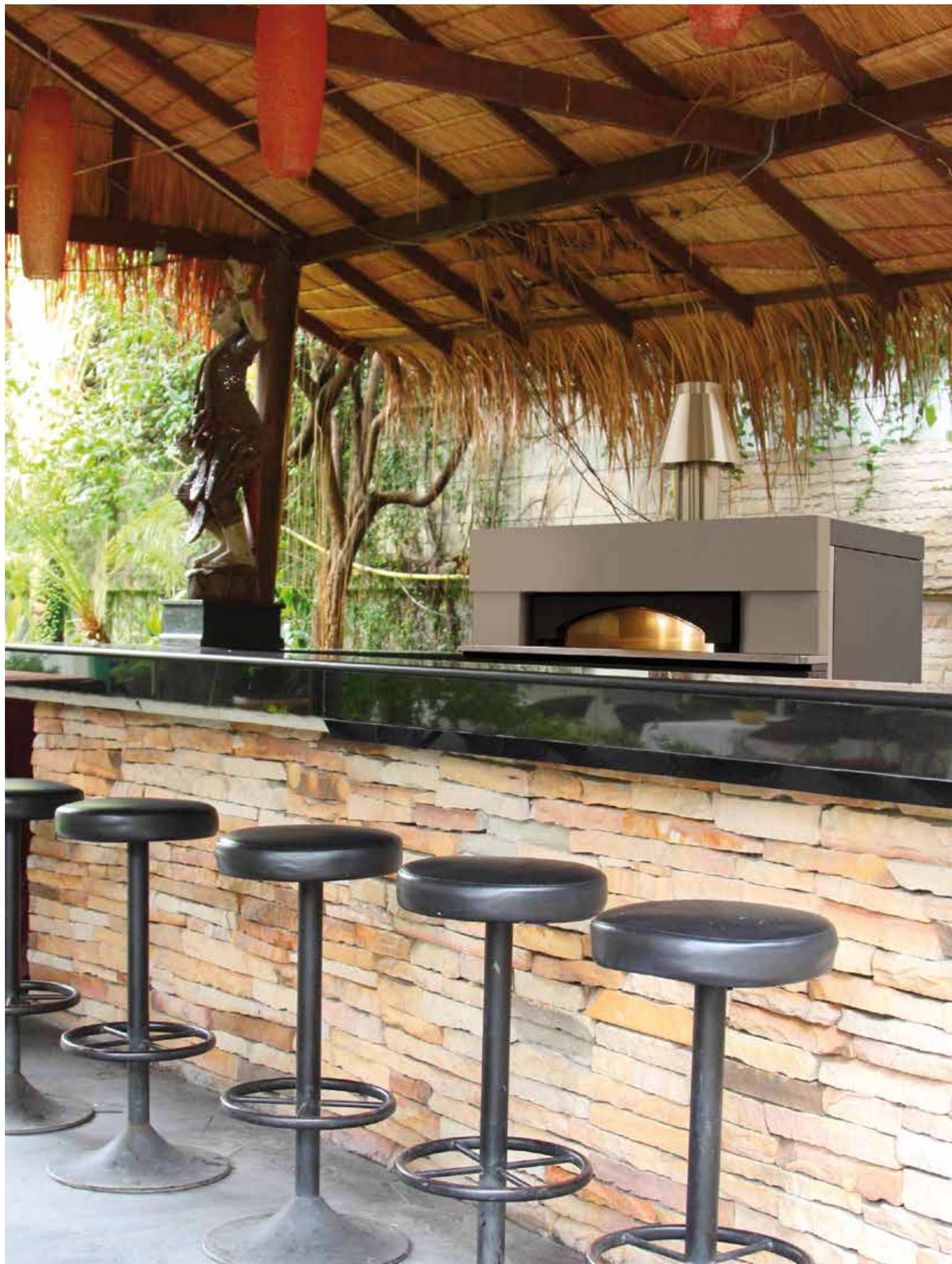



BEAK
VARIETIES, ROASTED & CRUSHED WITH
S, CURD, ROCKET MINT & LEMON
BRISKET, SLOW BRAISED IN
ERSHIRE SAUCE, SPARKENHOE RED
R, WATERCRESS & FRESH HORSE RADISH
ET
S, LINCOLNSHIRE POACHER CHEDDAR

SALAD PLATES
CRUNCHY SHAVED FENNEL
CLEMENTINE & RED GRAYON
CRISP
CRUSHED HAZELNUTS & ROAST GARLIC
GREEN SALAD
SALAD CREAM & HERB DRESSING
RAINBOW COLESLAW
RED LEICESTER, RUSSETS & WALNUTS

VOLTAIRE: IL TUO INGREDIENTE SEGRETO.
VOLTAIRE: YOUR SECRET INGREDIENT.

I dati riportati sul presente documento sono da ritenersi non vincolanti. oem Ali S.p.a. si riserva di apportare modifiche tecniche in qualsiasi momento.
The specifications shown in this document are to be considered not binding. oem Ali S.p.a. reserves the right to make technical changes at any moment.



oem
YOUR PIZZA HUB

Ali
GROUP

OEM Ali Group S.r.l. a Socio Unico - Viale Lombardia 33, Bozzolo, Mantova - Italy
M 0376 920 754 | T 0376 910 511 | F 0376 920 754 | info@oemali.com | www.oemali.com