

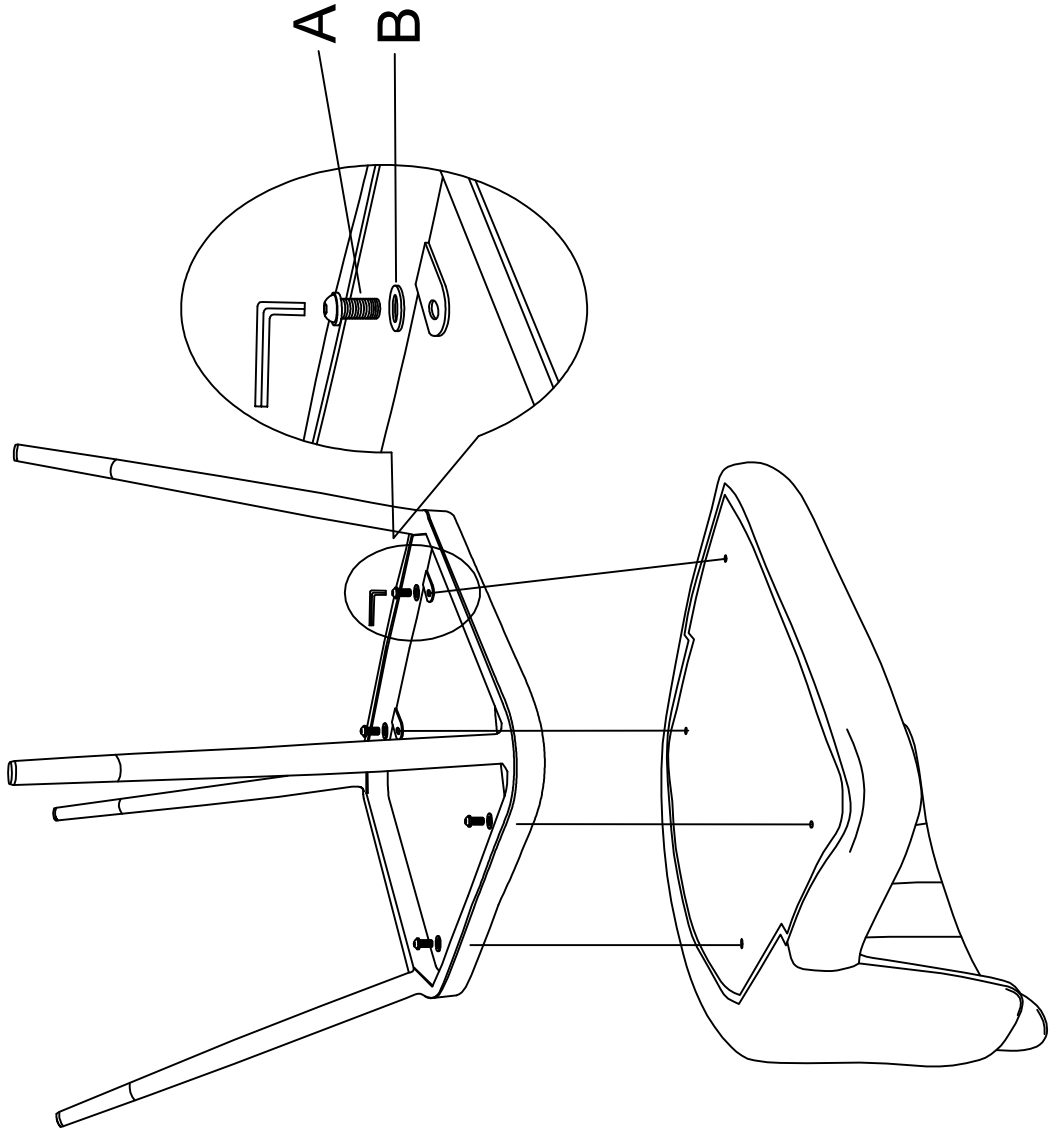

Step:1



A		x4
B		x4

Finish

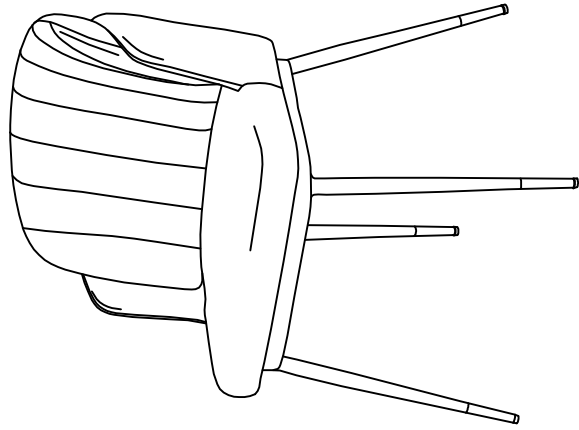

FDC8054

x1

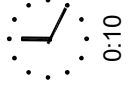
0:10

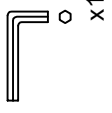
x1