



eternum   
created 1924

2018



Redda

eternum   
created 1924

PATTERN	REFERENCE	COLLECTION	PAGE
Adagio	2090	Eternum Signature	27
Alaska	2080	Eternum Signature	25
Alfa	959	Eternum	47
Alinéa	3020	Eternum Signature	28
Anser	1670	Eternum Signature	35
Anzo	1820	Eternum Signature	22
Appetize	3030	Eternum Signature	20
Arcade	1620	Eternum Signature	29
Artesia	983	Eternum	44
Ascot	3050	Eternum Signature	30
Atlantis	3010	Eternum Signature	24
Atrium	1870	Eternum Signature	32
Aude	1922	Eternum	56
Baguette	1610	Eternum Signature	34
Baguette LM	2610	Eternum	46
Byblos	1840	Eternum Signature	33
Châtelet	1680	Eternum Signature	38
Concorde	1400	Eternum	53
Contour	1800	Eternum Signature	37
Curve	964	Eternum	45
Diva	1721	Eternum	57
Doria	8004	Eternum	50
Ecobaguette	2611	Eternum	55
Élégance	966	Eternum	48
Fjord	1900	Eternum	52
Frida	958	Eternum	58
Galaxy	1720	Eternum	41
Ingres	1700	Eternum	53
Isabelle	2010	Eternum	56
Lipsi	2040	Eternum	54
Louvres	1650	Eternum Signature	36
Lugano	324	Eternum	49
Mahé	1810	Eternum Signature	18
Modena	957	Eternum	60
Neva	985	Eternum	42
Neva mat	986	Eternum	43
New Carmen	315	Eternum	59
Octo	1790	Eternum	57
Opera	968	Eternum	54
Orly	1420	Eternum	49
Oslo	1930	Eternum Signature	26
Pétale	1880	Eternum Signature	16
Rivoli	1921	Eternum	47
Ruban	1640	Eternum Signature	39
Rubis	1890	Eternum Signature	12
Rustic	8005	Eternum	50
Salsa	982	Eternum	51
Slow	3040	Eternum Signature	31
Sonate	977	Eternum	40
Trapez	2400	Eternum	51
Utah	973	Eternum	48
Verona	319	Eternum	59
Vesuve	951	Eternum	60
Vieux-Paris	1300	Eternum	55
X-Lo	3090	Eternum Signature	23
X15	1860	Eternum Signature	14





Content  
Sommaire  
Inhoud  
Inhalt  
Contenuto  
Contenido  
Spis treści  
Содержани  
Περιεχόμενα

## Who are we?

**Hotel reference list** | Références hôtelières | Referentielijst hotels | Hotelreferenzen | Elenco di riferimento hotel | Lista de referencia de hoteles | Lista referencyjna hotelu | Κατάλογος | Отели – наши клиенты | ξενοδοχείων αναφοράς

**Cutlery Eternum Signature** | Couverts Eternum Signature | Bestek Eternum Signature | Besteck Eternum Signature | Marchio Posateria Eternum | Cubertería Eternum Signature | Sztućce Eternum Signature | Столовые приборы Eternum Signature | Μαχαιροπήρουνα Eternum Signature

**Cutlery Eternum** | Couverts Eternum | Bestek Eternum Besteck Eternum | Posateria Eternum | Cubertería Eternum | Sztućce Eternum | Столовые приборы | Eternum | Μαχαιροπήρουνα Eternum

**Tableware Gastronum - Gastronomy luxury** | Articles de table Gastronum - Gastronomy luxury | Tafelartikelen Gastronum - Gastronomy luxury | Tischaccessoires Gastronum - Gastronomy luxury | Marchio Vasellame Gastronum - Gastronomy luxury | Artículos de mesa Firma Gastronum - Gastronomy luxury | Zastawa stołowa Gastronum - Gastronomy luxury | Столовая посуда Gastronum - Gastronomy luxury | Επιτραπέζια σκεύη Gastronum - Gastronomy luxury

**Tableware Gastronum - Catering Casual** | Articles de table Gastronum - Catering Casual | Tafelartikelen Gastronum - Catering Casual | Tischaccessoires Gastronum - Catering Casual Marchio Vasellame Gastronum - Catering Casual | Artículos de mesa Firma Gastronum - Catering Casual | Zastawa stołowa Gastronum - Catering Casual | Столовая посуда Gastronum - Catering Casual | Επιτραπέζια σκεύη Gastronum - Catering Casual

Qui sommes-nous ?  
Wie zijn we?  
Wer sind wir?  
¿Quiénes somos?  
Kim jesteśmy?  
О н а с ?

4

10

12

40

61

77

94

100

106

112

118

124

# Who are we?



Eternum  
Your cutlery  
specialist  
since 1924

Eternum was established in 1924.

Our headquarters are in Gembloux, Belgium, where our Belgian production unit and a warehouse for 3000 pallets are located.

We are a 100% subsidiary of the Norwegian K.A. Rasmussen group ([www.ka-rasmussen.no](http://www.ka-rasmussen.no)), a holding company specialised in the production and sale of noble metals for consumer and industrial markets.

Eternum focuses exclusively on stainless steel cutlery and accessories for table settings and buffets. Thanks to this specialised niche approach and our intensive product development policy we have developed into an important cutlery supplier at the international level.

We have a network of distributors and local representatives in 60 countries and our full selection is deliverable from stock.

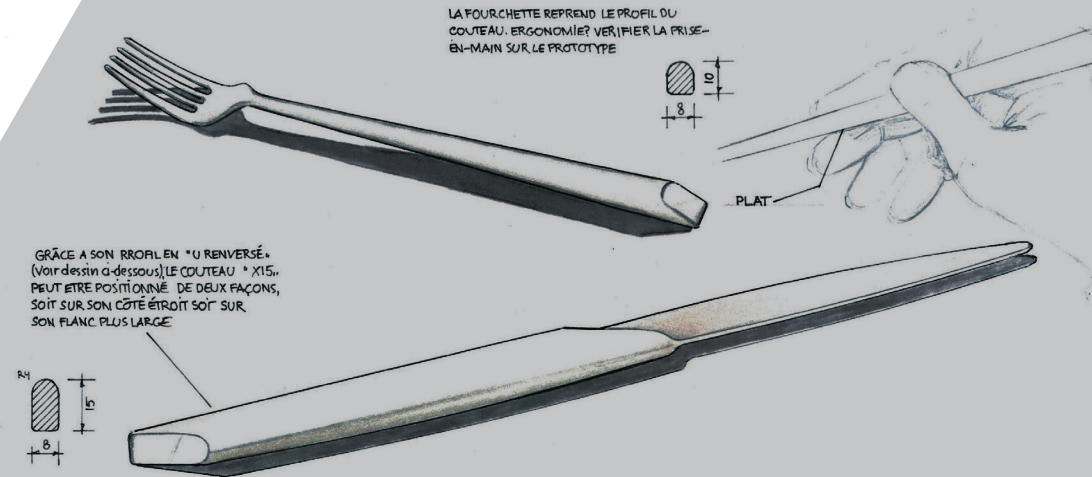

Dear Customer,

Eternum's vision and mission begin with you as customer, and our most important product is customer service.

Service not only in the form of 98% delivery reliability, but supplemented by that extra dimension that you as customer need now more than ever:

- the ability to quickly and flexibly respond to your questions and requirements,
- development of the right new products to increase your turnover and the satisfaction of your customers,
- strict management of our overhead expenses, allowing us to offer you quality at the right price.

We work daily to put this vision into practice in all aspects of the company, so that you can always count on the dedication of the whole Eternum team!

Always at your service,

Frank De Lombaert  
Executive Director

Tore Aasbakken  
Chairman, Board of Directors

# Designers

Belgium, as a small country in the centre of Europe, is a melting pot of various influences, languages and cultures.

Therefore as a Belgian company we work primarily with Belgian designers, some of whom have developed a strong reputation at the international level.



Designer of  
BELGIUM  
the year 2007



Nedda El Asmar  
**DESIGNER**  
[www.nedda.be](http://www.nedda.be)  
**WEB SITE**



Louis de Limburg  
**DESIGNER**  
[www.stirum-design.be](http://www.stirum-design.be)  
**WEB SITE**

Designer of  
BELGIUM  
the year 2008



Stefan Schöning  
**DESIGNER**  
[www.stefanschoning.com](http://www.stefanschoning.com)  
**WEB SITE**



Adrien Ciejak &  
Pierre Duthoit  
**DESIGNER**  
[www.plllus.com](http://www.plllus.com)  
[www.adrienciejak.com](http://www.adrienciejak.com)  
**WEB SITE**



Pierre Collard  
**DESIGNER**  
[www.pierrecollard.com](http://www.pierrecollard.com)  
**WEB SITE**



Louise Charlier  
**DESIGNER**  
[www.louisecharlier.be](http://www.louisecharlier.be)  
**WEB SITE**



Santiago Sevillano  
**DESIGNER**  
[www.santiagosevillano.com](http://www.santiagosevillano.com)  
**WEB SITE**

# Discover our 3 collections

eternum 

The Eternum range fits perfectly into a casual dining environment.

- > 18/10 as well as 18/0 steel is used.
- > New models are designed either by external designers or by our internal design department.

eternum   
*signature*



# gastronum

## DESIGN WITHIN ARMS REACH

Eternum Signature is a high-quality collection for higher level hotels and restaurants.

- > Only 18/10 steel is used.
- > New models are always developed in collaboration with external designers.

The Gastronum range is made up of a collection of tableware designed for:

- > luxurious gastronomy,
- > the catering sector.



We can **personalise**  
your orders  
to fit your needs  
perfectly

Embossing  
WITH OR WITHOUT RE-POLISHING



Etching



Laser engraving



Diamond engraving





Matt re-polishing



Sand blasting



Silver plating

**CUTLERY 33 OR 40 MICRONS  
TABLE WARE 10 OR 15 MICRONS**



Gold plating



PVD coating

**ANTHRACITE**



PVD coating

**GOLD**



**FOOD APPROVED - SCRATCH RESISTANT - MIN. 400 PCS/COLOUR**

**FOOD APPROVED - SCRATCH RESISTANT - MIN. 400 PCS/COLOUR**

# Eternum can be found in many luxury hotels

## AFRICA

Chad	N'Djamena	Kempinski
Kenya	Nairobi	Serena
Libya	Tripoli	Four points by Sheraton
Mauritius	Bel Ombre	Heritage Golf & Spa
Mauritius	Flic en Flac	Sofitel imperial
Morocco	Agadir	Hotel Tikida
Morocco	Casablanca	Mövenpick
Morocco	Essaouira	Sofitel Mogador
Morocco	Marrakech	La Villa des Orangers
Morocco	Marrakech	Les Jardins de la Koutoubia
Morocco	Marrakech	Hotel Nouara Barrière
Morocco	Marrakech	Sofitel Marrakech Lounge & Spa
Morocco	Rabat	Sofitel Rabat Jardin des Roses
Morocco	Casablanca	Sheraton
Morocco	Marrakech	Palmeria Golf Palace
Morocco	Essaouira	M'Gallery Le Medina
Morocco	Fès	Hotel Sahrai
Mozambique	Maputo	Serena Polana
Nigeria	Abuja	Hilton Nicon Noga
Seychelles	Praslin	Lemuria Resort
South Africa	Cape Town	Mount Nelson
South Africa	Johannesburg	Crowne Plaza The Rosebank
South Africa	Magaliesburg	Mount Grace Lodge
Tunisia	Tunis	The Residence
Uganda	Luanda	Talatona Convention hotel

## AMERICA (CENTRAL + CARIBBEAN)

Anguilla		Cap Juluca
Anguilla		CuisinArt Resort & Spa
Anguilla		Malliouhana hotel & Spa
Aruba		Amsterdam Manor Beach Resort
Aruba		Bucuti Beach Resort
Aruba		Divi Resorts
Aruba		Holiday Inn
Aruba		Hyatt Regency
Aruba		Manchebo Beach Resort & Spa
Aruba		Marriott
Aruba		The Mill Resort
Aruba		The Ritz-Carlton
Aruba		Radisson Resort & Spa
Aruba		Occidental Grand
Costa Rica	Playa Conchal	The Westin Golf Resort & Spa
Dominican Republic	Santo Domingo	Casas del XVI
Mexico	Cabo San Lucas	The Resort at Pedregal
Mexico	Cancun	Hyatt Ziva
Mexico	Guadalajara	Hyatt Regency Andares
Mexico	Mexico City	Sheraton Maria Isabel
Mexico	Punta De Mita	Imanta Resorts
Saint-Martin		La Samanna Luxury Resort & Spa
Saint-Martin		Westin Dawn Beach Resort & Spa

## AMERICA (SOUTH)

Colombia	Bogota	Sheraton
Colombia	Cali	Four points by Sheraton
Peru	Lima	Sol de Oro
Suriname		Bergendal Eco & Cultural River Resort
Uruguay	Colonia del Sacramento	Sheraton Colonia Golf & Spa
Uruguay	Punta Del Este	Awa Boutique + Design Hotel

## ASIA

Bhutan	Thimphu	Le Meridien
China	Beijing	Grand Millennium
China	Beijing	Shangri-La
China	Chanksha	Crowne Plaza
China	Chongqing	Holiday Inn
China	Hangzhou	Century Hotel Xiaoshan
China	Sanya	Crown Plaza
China	Sanya	Sanya Resort Intercontinental
China	Shanghai	Crowne Plaza Fudan
China	Shanghai	Four Seasons
China	Shanghai	Guoman Hotel
China	Shanghai	Novotel
China	Shenzhen	Crowne Plaza
China	Shenzhen	Four Points by Sheraton
China	Shenzhen	Intercontinental
China	Wuhan	Novotel
China	Xiamen	Crowne Plaza
Inde	Chennai	Hilton
Inde	Cochin	Le Meridien
Inde	Goa	Park Hyatt
Inde	Hyderabad	Minerva Grand
Inde	Mumbai	Renaissance Mumbai Convention Center Hotel
Inde	Mumbai	Westin
Inde	Sohna	Westin
Inde	Mumbai	JW Marriott Hotel
Inde	Hyderabad	The Westin Hyderabad Mindspace
Inde	Bangalore	Crowne Plaza
Indonesia	Bali	Conrad
Indonesia	Bali	Intercontinental Jimbaran
Indonesia	Bali	W Hotel Seminyak
Indonesia	Jakarta	Fairmont Hotel
Indonesia	Bali	Westin
Indonesia	Jakarta	Le Grandeur Hotel
Indonesia	Bali	Anantara Uluwatu
Japan	Tokyo	Mandarin Oriental
Kazakhstan	Astana	Okan InterContinental
Maldives	Male	Holiday Inn
Maldives	Falhumaafushi	The Residences
Maldives	Nyama	Per AQUUM
Philippines	Manila	City of Dreams Resort Hotel Casino
Singapore		Marriott
Thailande	Bangkok	Mandarin Oriental

## EUROPE (WESTERN AND SOUTHERN)

Austria	Seefeld in Tirol
Belgium	Antwerp
Belgium	Antwerp
Belgium	Antwerp
Belgium	Brussels
Belgium	Brussels
Belgium	Brussels
Belgium	Brussels
Belgium	Brussels
Belgium	Brussels
Belgium	Brussels
Belgium	Kortrijk
Belgium	Spa
Belgium	Zaventem
Belgium	Brussels
Cyprus	Sakarya
Cyprus	Limassol
Cyprus	Limassol
Cyprus	Limassol
Cyprus	Paphos
Denmark	Copenhagen
England	Heathrow
England	Liverpool
Finland	Helsinki
France	Orly
France	Paris
France	Strasbourg
France	Ribeauvillé
France	Nice
France	Nice
France	Mandelieu la Napoule
France	Marseille
Germany	Cologne
Germany	Fleesensee
Germany	Warnemünde
Germany	Murnau
Germany	Hamburg
Greece	Athens
Greece	Athens
Greece	Athens (Kifisia)
Greece	Corfu
Greece	Kos
Greece	Sithonia
Ireland	Cork
Ireland	Galway
Malta	St Julians
Netherlands	Amsterdam
Portugal	Acores
Portugal	Acores
Portugal	Acores
Portugal	Acores
Portugal	Lisbon
Portugal	Madeira
Slovenia	Celje

Hotel Princess Bergfrieden
Corinthia
Hilton
Holiday Inn Crowne Plaza
Hilton Brussels Grand Place
Hotel Palace Crowne Plaza
Husa President Park
Le Plaza
Silken Berlaymont
The Hotel Brussels
d-hotel
Radisson Blu
Crowne Plaza
Pullman Brussels Centre Midi
Intercontinental
Atlantica Group
Four Seasons
Le Meridien
Anassa Hotel
AC Hotel Bella Sky
Radisson Blu
Radisson Blu
Crowne Plaza
Hilton
Hilton
Hilton
Casino Barrière
Hôtel Beau Rivage
Hôtel Negresco
Hôtel Ermitage du Riou
Pullman Marseille Palm Beach
Radisson Blu
Robinson Club
A-Ja Resorts
Alpenhof
Scandic Emporio
Athena Grand Hotel
Melia
Twenty One
Corfu Imperial
Porto Bello Royal
Porto Carras Resort
Cork Airport Hotel
Radisson Blu
Inter-Continental
Softel The Grand
Hotel Avenida
Hotel Do Canal
Hotel Marina Atlantico
Terceira Mar Hotel
Acores Lisboa
Royal Savoy
Hotel Evropa

Spain	Madrid	Inter-Continental
Spain	Madrid (Barajas)	Hilton
Switzerland	Zurich	Park Inn
Turkey	Istanbul	Inter-Continental
Turkey	Konya	Hilton
Turkey	Antalya	Robinson Club Nobilis
Turkey	Fethiye	Hillside Beach Club

#### EUROPE (EASTERN)

Bulgaria	Sofia	Radisson Blu Grand Hotel
Czech Republic	Prague	Hotel Savoy
Hungary	Budapest	Holiday Beach
Hungary	Budapest	Polus Palace
Hungary	Tarcal	Andrassy Rezidencia Wine & Spa
Lithuania	Klaipeda	Radisson Blu
Poland	Warsaw	Radisson Blu
Poland	Wroclaw	Radisson Blu
Poland	Gdańsk	Hilton
Poland	Łódź	Doubletree by Hilton
Poland	Warsaw	Doubletree by Hilton
Poland	Serack	Hotel Warszawianka
Poland	Torún	Hotel Copernicus
Poland	Poznań	Hotel Puro
Poland	Wroclaw	Hotel Puro
Poland	Cracow	Hotel Puro
Poland	Opalenica	Hotel Remes
Poland	Krynica Zdrój	Hotel Czarny Potok
Poland	Płońsk	Hotel Bonifacio
Poland	Busko Zdrój	Hotel Stoneczny Zdrój
Poland	Cracow	Hotel Unicus
Poland	Wadowice	Hotel Młyn Jacka
Poland	Giżycko	Hotel St. Bruno
Poland	Elblag	Hotel Elblag
Poland	Cracow	Hotel Galaxy
Rumania	Bucharest	Hilton
Russia	Ekatarinenburg	Park Inn
Russia	Moscow	Park Inn Sadu
Russia	St-Petersburg	Park Inn Pribaltiskaya
Russia	Murmansk	Park Inn Polyarnie Zori
Russia	Kazan	Park Inn
Russia	Sochi	Park Inn City Center
Russia	Volgograd	Park Inn
Russia	Astrakhan	Park Inn
Russia	Moscow	Radisson Royal Hotel
Russia	Moscow	Radisson Blu Belorusskaya
Russia	Moscow	Radisson Slavyanskaya
Russia	Sochi	Radisson Blu Resort
Russia	Tverskaya obl	Radisson Zavidovo
Slovakia	Bratislava	Radisson Blu
Slovakia	Bratislava	Lindner

#### MIDDLE EAST

Bahrein	Riffa Views	The Royal Golf Club
Oman	Muscat	Radisson Blu
Qatar	Doha	Mercure Grand Hotel
Saudi Arabia	Makkah	Softel
Saudi Arabia	Riyadh	Holiday Inn
Syria	Damascus	Sheraton
UAE	Abu Dhabi	Sheraton
UAE	Al Ain	Hilton
UAE	Dubai	Dubai Creek Golf & Yacht Club
UAE	Dubai	Emirates Hotel
UAE	Dubai	Grand Hyatt
UAE	Dubai	Kempinski Mall of the Emirates
UAE	Dubai	Rotana hotels
UAE	Dubai	Royal Meridien
UAE	Dubai	Taj Palace Hotel
UAE	Fujeirah	Hilton
UAE	Ras Al Khaimah	Hilton
UAE	Ras Al Khaimah	Rak Hotel
UAE	Dubai	Pullman Deira City Centre
UAE	Ras Al Khaimah	Rixos Hotel
UAE	Dubai	Le Meridien Hotel & Conference Centre

#### OCEANIA

Australia	Brisbane	Grand Chancellor Hotel
Australia	Canberra	Rydges Lakeside Canberra Hotel
Australia	Melbourne	Hilton Convention Center
Australia	Melbourne	Softel
Australia	Melbourne	Crown Towers
Australia	Gold Coast	Softel
Australia	Sydney	Shangri La
Australia	Sydney	Pier One Sydney Autograph Collection
Australia	Sydney	Sheraton On The Park
Bora Bora		Le Meridien



Pierre Collard

**DESIGNER**

Rubis

**COLLECTION**

[www.pierrecollard.com](http://www.pierrecollard.com)

**WEB SITE**

Initiated by Dialogue Exhibition



# Rubis



eternum  
signature

1890

10 mm

18 - 10

Article	Description	Length (mm)	Gage (mm)	EAN 13: 5413521+	Master (Pcs)
1890-1	table fork	218	10	890015	120
1890-2	table spoon	218	10	890022	120
1890-5	table knife mono	244	133 gr	890053	120
1890-14	dessert fork	190	8	890145	120
1890-15	desert spoon	189	8	890152	120
1890-6	dessert knife mono	214	89 gr	890060	120
1890-3	tea spoon	140	6,6	890039	300
1890-26	mocca spoon	110	5,1	890268	300
1890-4	cake fork	142	6,8	890046	300
1890-16	fish fork	187	8	890169	300
1890-17	fish knife	218	8	890176	120
1890-33	soup spoon	182	8	890336	120
1890-40	fruit/butter knife	172	78 gr	890404	240

## STEAK KNIVES POM HANDLE NITROX® STEEL

Article	Description	Length (mm)	Gage (mm)	EAN 13: 5413521+	Master (Pcs)
813	steak knife brown	241	-	008137	120
814	steak knife ivory	241	-	008144	120



Louis de Limburg

DESIGNER

X15

COLLECTION

[www.stirum-design.be](http://www.stirum-design.be)

WEB SITE





# X15

STIRUM DESIGN

eternum  
signature

1860

10,0 mm

18 - 10

FORGED - FORGÉ - GESMEED - GESCHMIEDET

Article	Description	Length (mm)	Gage (mm)	EAN 13: 5413521+	Master (Pcs)
1860-1	table fork	218	10	860018	120
1860-2	table spoon	215	10	860025	120
1860-5	table knife mono	242	137 gr	860056	120
1860-14	dessert fork	193	8,5	860148	240
1860-15	dessert spoon	191	8,5	860155	240
1860-6	dessert knife mono	216	93 gr	860063	120
1860-3	tea spoon	143	6,5	860032	600
1860-26	mocca spoon	110	5,5	860261	600
1860-4	cake fork	144	6,5	860049	600
1860-16	fish fork	192	8,5	860162	240
1860-17	fish knife	206	8,5	860179	240
1860-33	soup spoon	189	8,5	860339	120
1860-40	fruit/butter knife	162	46 gr	860407	240
1860-25	cocktail spoon	213	9,5	860254	240
1860-45	steak knife	243	137	860452	120
1860-10	salad sever	300	10	860100	1

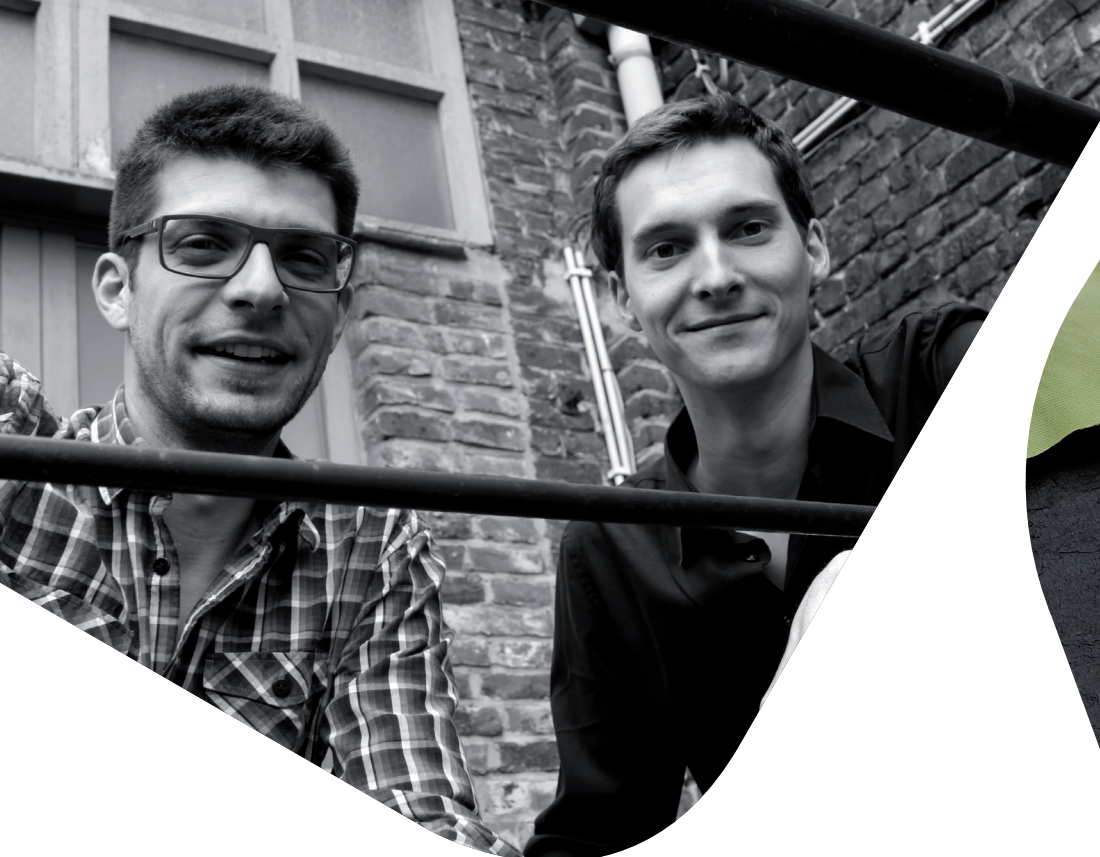

Adrien Ciejak & Pierre Duthoit

**DESIGNER**

Pétale

**COLLECTION**

[www.adrienciejak.com](http://www.adrienciejak.com) / [www.plllus.com](http://www.plllus.com)

**WEB SITE**







# Pétale

PIERRE DUTHOIT & ADRIEN CIEJAK

eternum  
signature

1880 | 5,5 mm | 18 - 10

FORGED - FORGÉ - GESMEED - GESCHMIEDET

Article	Description	Length (mm)	Gage (mm)	EAN 13: 5413521+	Master (Pcs)
1880-1	table fork	215	5,5	880016	120
1880-2	table spoon	215	5,5	880023	120
1880-5	table knife	240	108 gr	880054	120
1880-14	dessert fork	190	5	880146	120
1880-15	dessert spoon	190	5	880153	120
1880-6	dessert knife	215	74 gr	880061	120
1880-3	tea spoon	145	4,5	880030	300
1880-26	mocca spoon	110	3,5	880030	300
1880-4	cake fork	145	4,5	880047	300
1880-16	fish fork	190	5	880160	120
1880-17	fish knife	210	5	880177	120
1880-40	fruit/buter knife	165	48 gr	880405	240
1880-25	cocktail spoon	210	4	880252	300
1880-32	tasting spoon	210	5	880320	120
1880-10	salad server	300	5,5	880108	60



Santiago Sevillano

DESIGNER

Mahé

COLLECTION

[www.santiagosevillano.com](http://www.santiagosevillano.com)

WEB SITE



# Mahé

SANTIAGO SEVILLANO

eternum  
signature

1810

5 mm

18-10



Article	Description	Length (mm)	Gage (mm)	EAN 13: 5413521+	Master (Pcs)
1810-1	table fork	214	5	810013	120
1810-2	table spoon	214	5	810020	120
1810-5	table knife mono	237	123 gr	810051	120
1810-5V	table knife V	235	130 gr	810594	120
1810-14	dessert fork	188	3,2	810143	120
1810-15	dessert spoon	188	3,2	810150	120
1810-6	dessert knife mono	215	90 gr	810068	120
1810-6V	dessert knife V	213	110 gr	810563	120
1810-3	tea spoon	140	2,7	810037	300
1810-26	mocca spoon	110	2,2	810266	300
1810-4	cake fork	155	2,7	810044	300
1810-16	fish fork	184	3,2	810167	120
1810-17	fish knife	204	3,2	810174	120
1810-33	soup spoon	167	3,2	810334	240
1810-40	fruit/butter knife	172	80 gr	810402	240
1810-45	steak knife	237	123 gr	810457	120
1810-12	serving spoon	245	4,3	810129	120
1810-21	serving fork	245	4,3	810211	120

.....  
BELGIUM  
DESIGNER  
OF THE YEAR  
2007  
.....



Nedda El Asmar

DESIGNER

Appetize

COLLECTION

[www.nedda.be](http://www.nedda.be)

WEB SITE





3030-41



3030-34



3030-39

# Appetize

NEDDA EL ASMAR

eternum  
signature

3030

2,5 mm

18 - 10

FORGED - FORGÉ - GESMEED - GESCHMIEDET



















Article	Description	Length (mm)	Gauge (mm)	EAN 13: 5413521+	Master (Pcs)
3030-1	table fork	216	2,5	30015	120
3030-2	table spoon	215	2,5	30022	120
3030-5	table knife mono	238	91 gr	30053	120
3030-14	dessert fork	184	2,5	30145	120
3030-15	dessert spoon	184	2,5	30152	120
3030-6	dessert knife mono	200	63 gr	30060	120
3030-3	tea spoon	141	2	30039	600
3030-26	mocca spoon	105	1,8	30268	600
3030-17	fish knife	209	2,5	30176	120
3030-40	fruit/butter knife	140	51 gr	30404	240
3030-25	cocktail spoon	199	2,5	30251	120
3030-41	combi-stick	228	2,5	30411	300
3030-10	salad server	340	2	30107	1
3030-34	zakouski spoon 18-0	99	2	030343	300
3030-39	zakouski fork 18-0	100	2,5	030398	600

# Anzo

## STIRUM DESIGN

eternum *signature* | 1820 | 4,1 mm | 18 - 10















Article	Description	Length (mm)	Gage (mm)	EAN 13: 5413521+	Master (Pcs)
1820-1	 table fork	212	4,1	820012	300
1820-2	 table spoon	214	4,1	820029	240
1820-5E	 table knife ergo	235	121 gr	820593	120
1820-14	 dessert fork	192	3,1	820142	300
1820-15	 dessert spoon	194	3,1	820159	300
1820-6	 dessert knife mono	215	86 gr	820067	120
1820-6E	 dessert knife ergo	215	88 gr	820562	120
1820-3	 tea spoon	147	2,6	820036	600
1820-26	 mocca spoon	110	2,2	820265	600
1820-4	 cake fork	147	2,6	820043	600
1820-16	 fish fork	192	3,1	820166	300
1820-17	 fish knife	217	3,1	820173	300
1820-33	 soup spoon	184	3,1	820333	300
1820-40	 fruit/butter knife	160	38 gr	820401	300
1820-45E	 steak knife ergo	235	120 gr	820456	120
1820-25	 cocktail spoon	210	3,1	820258	300





X-LO

eternum *signature* : 3090 : 3,5 mm : 18 - 10

Article		Description	Length (mm)	Gauge (mm)	EAN 13: 5413521+	Master (Pcs)
3090-1		table fork	220	3,5	309012	300
3090-2		table spoon	220	3,5	309029	300
3090-5		table knife	244	80 gr	309050	120
3090-14		dessert fork	193	3	309142	300
3090-15		dessert spoon	193	3	309159	300
3090-6		dessert knife	219	58 gr	309067	240
3090-3		tea spoon	144	2,5	309036	600
3090-26		mocca spoon	110	2,5	309265	600
3090-4		cake fork	141,5	2,5	309043	600
3090-16		fish fork	182,5	3	309166	300
3090-17		fish knife	208,5	3	309173	300
3090-33		soup spoon	182	3	309333	300
3090-40		fruit/butter knife	165	6,5 gr	309401	300
3090-45		steak knife	244	8 gr	309456	120

# Atlantis

STIRUM DESIGN

eternum  
*signature*

3010 4,0 mm 18 - 10



Article	Description	Length (mm)	Gage (mm)	EAN 13: 5413521+	Master (Pcs)
3010-1	table fork	212	4	310018	300
3010-2	table spoon	211	4	310025	300
3010-5	table knife mono	234	111 gr	310056	120
3010-5V	table knife mono "vertical"	233	100 gr	310599	120
3010-51	table knife HH	233	-	310513	120
3010-14	dessert fork	187	3	310148	300
3010-15	dessert spoon	185	3	310155	300
3010-6	dessert knife mono	211	78 gr	310063	120
3010-6V	dessert knife mono "vertical"	212	78 gr	310568	120
3010-61	dessert knife HH	213	-	310612	120
3010-3	tea spoon	145	2,5	310032	600
3010-26	mocca spoon	114	2,5	310261	600
3010-4	cake fork	145	2,5	310049	600
3010-16	fish fork	186	3	310162	300
3010-17	fish knife	199	3	310179	300
3010-33	soup spoon	173	3	310339	300
3010-40	fruit/butter knife	163	39 gr	310407	300
3010-45	steak knife	234	108 gr	310452	120
3010-25	cocktail spoon	206	3	310254	300
3010-32	tasting spoon	181	3	310322	300
3010-7	soup ladle	296	3	310070	1
3010-8	cake server	256	4	310087	1
3010-10	salad server	295	4	310100	1
3010-11	gravy ladle	186	4	310117	1
3010-12	serving spoon	224	4	310124	1
3010-21	serving fork	245	3,5	310216	1



# Alaska

STIRUM DESIGN

eternum  
signature

2080

3,5 mm

18 - 10





















Spaghetti cutlery

Article	Description	Length (mm)	Gage (mm)	EAN 13: 5413521+	Master (Pcs)
2080-1	table fork	203	3,5	208018	300
2080-2	table spoon	205	3,5	208025	300
2080-5	table knife mono	226	68 gr	208056	120
2080-14	dessert fork	181	3	208148	300
2080-15	dessert spoon	181	3	208155	300
2080-6	dessert knife mono	203	50 gr	208063	120
2080-3	tea spoon	140	2,5	208032	600
2080-26	mocca spoon	118	2,2	208261	600
2080-4	cake fork	143	2,5	208049	600
2080-16	fish fork	187	3	208162	300
2080-17	fish knife	192	3	208179	300
2080-45	steak knife	225	68 gr	208452	240
2080-25	cocktail spoon	200	3,2	208254	300
2080-35	spaghetti fork	220	3,5	208353	300
2080-36	spaghetti spoon	213	3,5	208360	300
2080-7	soup ladle	165	3,5	208070	1
2080-8	cake server	259	3,5	208087	1
2080-10	salad server	234	3,5	208100	1
2080-11	gravy ladle	173	3,5	208117	1
2080-12	serving spoon	215	3,5	208124	1
2080-33	soup spoon	182	3,2	208339	300
2080-40	fruit / butter knife	160	30	208407	300

# Oslo

STIRUM DESIGN

eternum *signature* 1930 4,0 mm 18 - 10

Article	Description	Length (mm)	Gage (mm)	EAN 13: 5413521+	Master (Pcs)
1930-1	 table fork	210	4	930018	300
1930-2	 table spoon	209	4	930025	240
1930-5	 table knife mono	235	113 gr	930056	120
1930-14	 dessert fork	188	2,8	930148	300
1930-15	 dessert spoon	188	2,8	930155	300
1930-6	 dessert knife mono	215	86 gr	930063	120
1930-3	 tea spoon	145	2,5	930032	600
1930-26	 mocca spoon	116	2,5	930261	600
1930-4	 cake fork	142	2,5	930049	600
1930-16	 fish fork	189	2,8	930162	300
1930-17	 fish knife	210	2,8	930179	300
1930-33	 soup spoon	184	2,8	930339	300
1930-40	 fruit/butter knife	160	45 gr	930407	300
1930-45	 steak knife	242	112 gr	930452	120
1930-7	 soup ladle	276	3	930070	1
1930-8	 cake server	244	3	930087	1
1930-10	 salad server	301	3	930100	1
1930-11	 gravy ladle	168	2,8	930117	1
1930-12	 serving spoon	250	3	930124	1



# Adagio

STIRUM DESIGN











eternum  
*signature*

2090

4,0 mm

18 - 10























Article	Description	Length (mm)	Gage (mm)	EAN 13: 5413521+	Master (Pcs)
2090-1	 table fork	204	4	209015	300
2090-2	 table spoon	205	4	209022	300
2090-5	 table knife mono	224	87 gr	209053	120
2090-51	 table knife HH	224	-	209510	240
2090-14	 dessert fork	183	3	209145	300
2090-15	 dessert spoon	180	3	209152	300
2090-6	 dessert knife mono	202	60 gr	209060	120
2090-61	 dessert knife HH	202	-	209619	240
2090-3	 tea spoon	137	2,5	209039	600
2090-26	 mocca spoon	116	2,5	209268	600
2090-4	 cake fork	140	2,5	209046	600
2090-16	 fish fork	189	3	209169	300
2090-17	 fish knife	201	3	209176	300
2090-40	 fruit/butter knife	162	40 gr	209404	300
2090-7	 soup ladle	281	4	209077	1
2090-8	 cake server	242	4	209084	1
2090-10	 salad server	235	4	209107	1
2090-11	 gravy ladle	174	3,5	209114	1
2090-12	 serving spoon	251	4	209121	1

# Alinea

STIRUM DESIGN

eternum *signature* | 3020 | 4,0 mm | 18 - 10

Article	Description	Length (mm)	Gage (mm)	EAN 13: 5413521+	Master (Pcs)
3020-1	 table fork	208	4	320017	240
3020-2	 table spoon	208	4	320024	240
3020-5	 table knife mono	240	117 gr	320055	120
3020-14	 dessert fork	193	3	320147	300
3020-15	 dessert spoon	191	3	320154	300
3020-6	 dessert knife mono	218	85 gr	320062	120
3020-3	 tea spoon	143	2,5	320031	600
3020-26	 mocca spoon	114	2,2	320260	600
3020-4	 cake fork	149	2,5	320048	600
3020-16	 fish fork	194	3	320161	300
3020-17	 fish knife	208	3	320178	300
3020-33	 soup spoon	184	3	320338	300
3020-40	 fruit/butter knife	159	42 gr	320406	300
3020-45	 steak knife	245	121 gr	320451	120
3020-7	 soup ladle	280	4	320079	1
3020-8	 cake server	258	4	320086	1
3020-10	 salad server	289	4	320109	1
3020-11	 gravy ladle	170	3,5	320116	1
3020-12	 serving spoon	248	4	320123	1
3020-21	 serving fork	248	4	320215	1



# Arcade

STIRUM DESIGN



eternum  
signature

1620

3,5 mm

18 - 10

Article	Description	Length (mm)	Gage (mm)	EAN 13: 5413521+	Master (Pcs)
1620-1	table fork	208	3,5	620018	300
1620-2	table spoon	208	3,6	620025	300
1620-5	table knife mono	238	106 gr	620056	120
1620-51	table knife HH	240	-	620513	240
1620-14	dessert fork	186	2,8	620148	300
1620-15	dessert spoon	185	2,8	620155	300
1620-6	dessert knife mono	214	79 gr	620063	120
1620-61	dessert knife HH	215	-	620612	240
1620-3	tea spoon	142	2,5	620032	600
1620-26	mocca spoon	117	2,2	620261	600
1620-4	cake fork	144	2,3	620049	600
1620-16	fish fork	180	2,8	620162	300
1620-17	fish knife	201	2,8	620179	300
1620-33	soup spoon	173	2,8	620339	300
1620-40	fruit/butter knife	160	36 gr	620407	300
1620-45	steak knife	238	106 gr	620452	120





















The Arcade pattern can be combined with the patterns Ascot (page 30) and Beaubourg (page 31), offering you 70 items to compose any table setting!



# Ascot

STIRUM DESIGN

eternum *signature* 3050 3,0 mm 18 - 10

Article	Description	Length (mm)	Gage (mm)	EAN 13: 5413521+	Master (Pcs)
3050-1	 table fork	207	3	350014	300
3050-2	 table spoon	207	3	350021	240
3050-5	 table knife mono	231	110 gr	350052	120
3050-14	 dessert fork	183	2,5	350144	300
3050-15	 dessert spoon	184	2,5	350151	300
3050-6	 dessert knife mono	208	77 gr	350069	120
3050-3	 tea spoon	146	2,2	350038	600
3050-26	 mocca spoon	115	2	350267	600
3050-4	 cake fork	145	2	350045	600
3050-16	 fish fork	178	2,5	350168	300
3050-17	 fish knife	197	2,5	350175	300
3050-33	 soup spoon	170	2,5	350335	300
3050-40	 fruit/butter knife	158	38 gr	350403	300
3050-19	 oyster fork	136	2,2	350199	600
3050-20	 snail fork	142	2,2	350205	600
3050-45	 steak knife	236	114 gr	350458	120
3050-7	 soup ladle	302	3	350076	1
3050-8	 cake server	231	2,5	350083	1
3050-10	 salad server	286	3	350106	1
3050-11	 gravy ladle	169	2,5	350113	1
3050-12	 serving spoon	245	3	350120	1



# Slow



















eternum  
*signature*

3040

4 mm

18 - 10

Article		Description	Length (mm)	Gage (mm)	EAN 13: 5413521+	Master (Pcs)
3040-1		table fork	216	4	340015	300
3040-2		table spoon	216	4	340022	300
3040-5		table knife	236	100 gr	340053	120
3040-14		dessert fork	190	3	340145	300
3040-15		dessert spoon	190	3	340152	300
3040-6		dessert knife	210	72 gr	340060	240
3040-3		tea spoon	140	2,5	340039	600
3040-26		mocca spoon	105	2,2	340268	600
3040-4		cake fork	145	2,5	340046	600
3040-16		fish fork	186	3	340169	300
3040-17		fish knife	202	3	340176	300
3040-33		soup spoon	181	3	340336	300
3040-40		fruit/butter knife	162	-	340404	240
3040-45		steak knife	236	98 gr	340459	120
3040-25		cocktail spoon	206	2,5	340251	300
3040-10		salad server	290	3,5	340107	20
3040-12		serving spoon	245	4	340121	20

# Atrium

STIRUM DESIGN

eternum  
*signature*

1870

7,0 mm

18 - 10

FORGED - FORGÉ - GESMEED - GESCHMIEDET

Article	Description	Length (mm)	Gage (mm)	EAN 13: 5413521+	Master (Pcs)
1870-1	table fork	209	7	870017	120
1870-2	table spoon	210	7	870024	120
1870-5	table knife mono	233	136 gr	870055	120
1870-14	dessert fork	190	6	870147	120
1870-15	dessert spoon	190	6	870154	120
1870-6	dessert knife mono	213	96 gr	870062	120
1870-3	tea spoon	145	4	870031	300
1870-26	mocca spoon	110	3	870260	300
1870-4	cake fork	145	4	870048	300
1870-16	fish fork	190	6	870161	120
1870-17	fish knife	206	6	870178	120
1870-33	soup spoon	190	6	870338	120
1870-40	fruit/butter knife	161	42 gr	870406	240





# Byblos

eternum  
*signature*

1840

3,5 mm

18 - 10

Article	Description	Length (mm)	Gage (mm)	EAN 13: 5413521+	Master (Pcs)
1840-1	table fork	209	3,5	840010	300
1840-2	table spoon	207	3,5	840027	240
1840-5	table knife	239	144	840058	120
1840-51	table knife HH	239	-	840515	240
1840-14	dessert fork	183	3	840140	300
1840-15	dessert spoon	182	3	840157	300
1840-6	dessert knife	216	95	840065	120
1840-61	dessert knife HH	214	-	840614	240
1840-3	tea spoon	143	2,5	840034	600
1840-26	mocca spoon	116	2,2	840263	600
1840-4	cake fork	146	2,8	840041	600
1840-16	fish fork	178	3,2	840164	300
1840-17	fish knife	197	3,2	840171	300
1840-33	soup spoon	172	3,2	840331	300
1840-40	fruit/butter knife	162	41	840409	180
1840-25	cocktail spoon	192	3,2	840256	300
1840-18	icecream spoon	138	2,7	840188	600
1840-19	oyster fork	136	2,7	840195	600
1840-20	snail fork	143	2,5	840201	600
1840-32	tasting spoon	180	3,2	840324	300
1840-23	carving fork	246	-	840232	1
1840-24	carving knife	287	-	840249	1
1840-27B	butter knife mono	158	2,5	840270	1
1840-27	butter knife HH	204	-	840270	1
1840-28	cheese knife HH	200	-	840287	1
1840-29	cake knife HH	250	-	840294	1
1840-30	fish serving fork	233	-	840300	1
1840-31	fish serving knife	267	-	840317	1



# Baguette

eternum  
signature

1610

3,5 mm

18 - 10



Article	Description	Length (mm)	Gage (mm)	EAN 13: 5413521+	Master (Pcs)
1610-1	table fork	206	3,5	610019	300
1610-2	table spoon	205	3,5	610026	300
2610-5	table knife mono	238	111 gr	261051	120
1610-51	table knife HH	250	-	610514	240
1610-14	dessert fork	184	3	610149	300
1610-15	dessert spoon	187	3	610156	300
2610-6	dessert knife mono	212	84 gr	261068	120
1610-61	dessert knife HH	222	-	610613	240
1610-3	tea spoon	137	2,5	610033	600
1610-26	mocca spoon	111	2	610262	600
1610-4	cake fork	152	2,5	610040	600
1610-16	fish fork	181	3	610163	300
1610-17	fish knife	200	3	610170	300
1610-33	soup spoon	163	2,5	610330	300
1610-40	fruit/butter knife	165	43 gr	610408	300
1610-45	steak knife	236	-	610453	240
1610-25	cocktail spoon	201	3	610255	300
1610-32	tasting spoon	182	2,5	610323	300
1610-7	soup ladle	284	3,5	610071	1
1610-8	cake server	249	3,5	610088	1
1610-10	salad server	200	3,5	610101	1
1610-11	gravy ladle	168	3,5	610118	1
1610-12	serving spoon	251	3,5	610125	1

Article	Description	Length (mm)	Gage (mm)	EAN 13: 5413521+	Master (Pcs)
1670-1	table fork	208	3	670013	300
1670-2	table spoon	207	3	670020	240
1670-5	table knife mono	236	113 gr	670051	120
1670-51	table knife HH	237	-	670518	120
1670-14	dessert fork	183	2,5	670143	300
1670-15	dessert spoon	183	2,5	670150	300
1670-6	dessert knife mono	213	95 gr	670068	120
1670-61	dessert knife HH	215	-	670617	120
1670-3	tea spoon	143	2,2	670037	600
1670-26	mocca spoon	118	2,2	670266	600
1670-4	cake fork	145	2,2	670044	600
1670-16	fish fork	173	2,5	670167	300
1670-17	fish knife	196	2,5	670174	300
1670-33	soup spoon	173	2,5	670334	300
1670-40	fruit/butter knife	160	48 gr	670402	300
1670-45	steak knife	235	113 gr	670457	120
1670-25	cocktail spoon	192	2,5	670259	300
1670-18	icecream spoon	131	2	670181	600
1670-19	oyster fork	136	2,2	670198	600
1670-20	snail fork	142	2	670204	600
1670-32	tasting spoon	182	2,5	670327	300
1670-7	soup ladle	312	2,5	670075	1
1670-8	cake server	257	2,5	670082	1
1670-9	chips server	256	2,5	670099	1
1670-10	salad server	212	2,5	670105	1
1670-11	gravy ladle	182	2,5	670112	1
1670-12	serving spoon	225	2,5	670129	1
1670-21	serving fork	214	2,2	670211	1
1670-23	carving fork	245	-	670235	1
1670-24	carving knife	290	-	670242	1
1670-27	butter knife HH	207	-	670273	1
1670-28	cheese knife HH	200	-	670280	1
1670-29	cake knife HH	249	-	670297	1
1670-30	fish serving fork	235	-	670303	1
1670-31	fish serving knife	265	-	670310	1

# Anser

eternum  
*signature*

1670

3,0 mm

18 - 10



# Louvres

eternum  
signature

1650 3,0 mm 18 - 10



Article	Description	Length (mm)	Gage (mm)	EAN 13: 5413521+	Master (Pcs)
1650-1 S	table fork	207	3	650015	300
1650-2 S	table spoon	206	3	650022	300
1650-5	table knife mono	236	112 gr	650053	240
1650-51	table knife HH	236	-	650510	240
1650-14 S	dessert fork	183	2,5	650145	300
1650-15 S	dessert spoon	183	2,5	650152	300
1650-6	dessert knife mono	213	94 gr	650060	240
1650-61	dessert knife HH	212	-	650619	240
1650-3 S	tea spoon	145	2,5	650039	600
1650-26 S	mocca spoon	116	2,5	650268	600
1650-4	cake fork	142	2	650046	600
1650-16 S	fish fork	181	2,5	650169	300
1650-17 S	fish knife	197	2,5	650176	300
1650-33	soup spoon	166	2,5	650336	300
1650-25	cocktail spoon	193	2,5	650251	300
1650-21	serving fork	214	3	650213	1
1650-23	carving fork	248	-	650237	1
1650-24	carving knife	290	-	650244	1
1650-27B	butter knife mono	162	2,5	650275	1
1650-27	butter knife HH	212	-	650275	1
1650-28	cheese knife HH	212	-	650282	1
1650-29	cake knife HH	234	-	650299	1
1650-30	fish serving fork	240	-	650305	1
1650-31	fish serving knife	271	-	650312	1

# Contour

eternum  
*signature*

1800

3,0 mm

18 - 10

Article	Description	Length (mm)	Gage (mm)	EAN 13: 5413521+	Master (Pcs)
1800-1	table fork	207	3	800014	300
1800-2	table spoon	209	3	800021	300
1800-5	table knife mono	249	120 gr	800052	120
1800-51	table knife HH	244	-	800519	120
1800-14	dessert fork	183	2,5	800144	300
1800-15	dessert spoon	183	2,5	800151	300
1800-6	dessert knife mono	215	84 gr	800069	240
1800-61	dessert knife HH	212	-	800618	240
1800-3	tea spoon	143	2,5	800038	600
1800-26	mocca spoon	116	2,2	800267	600
1800-4	cake fork	144	2,2	800045	600
1800-16	fish fork	181	2,5	800168	300
1800-17	fish knife	198	2,5	800175	300
1800-40	fruit/butter knife	160	45 gr	800403	300
1800-21	serving fork	214	3	800212	1
1800-23	carving fork	248	-	800236	1
1800-24	carving knife	290	-	800243	1
1800-27	butter knife HH	206	-	800274	1
1800-28	cheese knife HH	205	-	800281	1
1800-29	cake knife HH	250	-	800298	1
1800-30	fish serving fork	235	-	800304	1
1800-31	fish serving knife	265	-	800311	1



# Châtelet

eternum  
signature

1680 3,0 mm 18-10



Article	Description	Length (mm)	Gage (mm)	EAN 13: 5413521+	Master (Pcs)
1680-1	table fork	206	3	680012	300
1680-2	table spoon	207	3	680029	300
1680-5	table knife mono	237	110 gr	680050	120
1680-51	table knife HH	238	-	680517	120
1680-14	dessert fork	183	2,5	680142	300
1680-15	dessert spoon	182	2,5	680159	300
1680-6	dessert knife mono	215	104 gr	680067	120
1680-61	dessert knife HH	219	-	680616	120
1680-3	tea spoon	144	2,2	680036	600
1680-4	cake fork	145	2,2	680043	600
1680-16	fish fork	175	2,5	680166	300
1680-17	fish knife	195	2,5	680173	300
1680-40	fruit/butter knife	160	50 gr	680401	300
1680-25	cocktail spoon	193	2,5	680258	300
1680-21	serving fork	214	3	680210	1
1680-23	carving fork	240	-	680234	1
1680-24	carving knife	285	-	680241	1
1680-28	cheese knife HH	200	-	680289	1
1680-29	cake knife HH	245	-	680296	1
1680-30	fish serving fork	235	-	680302	1
1680-31	fish serving knife	265	-	680319	1

# Ruban

eternum  
*signature*

1640

3,0 mm

18 - 10

Article	Description	Length (mm)	Gage (mm)	EAN 13; 5413521+	Master (Pcs)
1640-1	table fork	202	3	640016	300
1640-2	table spoon	206	2,5	640023	300
1640-5	table knife mono	245	124 gr	640054	120
1640-14	dessert fork	182	2,5	640146	300
1640-15	dessert spoon	182	2,5	640153	300
1640-6	dessert knife mono	221	75 gr	640061	240
1640-3	tea spoon	143	2,5	640030	600
1640-26	mocca spoon	117	2,2	640269	600
1640-4	cake fork	145	2,2	640047	600
1640-16	fish fork	175	2,5	640160	300
1640-17	fish knife	194	2,5	640177	300
1640-33	soup spoon	173	2,5	640337	300
1640-25	cocktail spoon	192	2,5	640252	300
1640-7	soup ladle	312	2,5	640078	1
1640-8	cake server	257	2,5	640085	1
1640-9	chips server	256	2,5	640092	1
1640-10	salad server	212	2,5	640108	1
1640-11	gravy ladle	182	2,5	640115	1
1640-12	serving spoon	237	2,5	640122	1



# Sonate

STIRUM DESIGN

eternum

977

3,0 mm

18 - 10



Article	Description	Length (mm)	Gage (mm)	EAN 13: 5413521+	Master (Pcs)
977-1	table fork	199	3	977013	300
977-2	table spoon	198	3	977020	300
977-5	table knife mono	219	76 gr	977051	300
977-14	dessert fork	181	2,2	977143	300
977-15	dessert spoon	175	2,2	977150	300
977-6	dessert knife mono	191	56 gr	977068	300
977-3	tea spoon	143	2	977037	600
977-26	mocca spoon	114	1,8	977266	600
977-4	cake fork	149	2	977044	600
977-16	fish fork	180	2,2	977167	300
977-17	fish knife	206	2,2	977174	300
977-33	soup spoon	176	1,8	977334	300
977-45	steak knife	228	82 gr	977457	120
977-7	soup ladle	260	2,8	977075	1
977-8	cake server	255	2,8	977082	1
977-10	salad server	225	2,8	977105	1
977-11	gravy ladle	170	2,8	977112	1
977-12	serving spoon	243	2,8	977129	1





# Galaxy

STIRUM DESIGN

eternum 1720 : 3,0 mm : 18 - 10 : mirror  
 1723 : 3,0 mm : 18 - 10 : mat

Article	Description	Length (mm)	Gage (mm)	EAN 13: 5413521+	Master (Pcs)
1720-1	table fork	208	3	172012	300
1720-2	table spoon	207	3	172029	300
1720-5	table knife mono	228	75 gr	172050	240
1720-14	dessert fork	190	2,5	172142	300
1720-15	dessert spoon	188	2,5	172159	300
1720-6	dessert knife mono	203	-	172067	300
1720-3	tea spoon	145	2	172036	600
1720-26	mocca spoon	114	1,8	172265	600
1720-4	cake fork	148	2	172043	600
1720-16	fish fork	190	2,5	172166	300
1720-17	fish knife	208	2,5	172173	300
1720-7	soup ladle	267	3	172074	1
1720-8	cake server	255	2,8	172081	1
1720-10	salad server	232	3	172104	1
1720-11	gravy ladle	160	2,8	172111	1
1720-12	serving spoon	248	2,8	172128	1

1723-1	table fork	208	3	1723016	300
1723-2	table spoon	207	3	1723023	300
1723-5	table knife	228	75 gr	1723054	240
1723-3	tea spoon	145	2	1723030	600



# Neva

LOUISE CHARLIER - WWW.MEDIANE.BE

eternum 985 2,5 mm 18 - 10 mirror

Initiated by Dialogue Exhibition



Article	Description	Length (mm)	Gage (mm)	EAN 13: 5413521+	Master (Pcs)
985-1	table fork	214	2,5	985018	300
985-2	table spoon	214	2,5	985025	300
985-5	table knife mono	235	88 gr	985056	120
985-14	dessert fork	188	2,5	985148	300
985-15	dessert spoon	188	2,5	985155	300
985-6	dessert knife mono	208	56 gr	985063	240
985-3	tea spoon	140	2	985032	600
985-26	mocca spoon	101	1,8	985261	600
985-16	fish fork	188	2,5	985162	300
985-17	fish knife	215	2,5	985179	300











# Neva mat

LOUISE CHARLIER - WWW.MEDIANE.BE











eternum 986 2,5 mm 18 - 10 mat

Initiated by Dialogue Exhibition

Article		Description	Length (mm)	Gage (mm)	EAN 13: 5413521+	Master (Pcs)
986-1		table fork	214	2,5	986015	300
9856-2		table spoon	214	2,5	986022	300
986-5		table knife mono	235	88 gr	986053	120
986-14		dessert fork	188	2,5	986145	300
986-15		dessert spoon	188	2,5	986152	300
986-6		dessert knife mono	208	56 gr	986060	240
986-3		tea spoon	140	2	986039	600
986-26		mocca spoon	101	1,8	986268	600

# Artesia

eternum  983 2,5 mm 18 - 10 chiseled mat

Article	Description	Length (mm)	Gage (mm)	EAN 13: 5413521+	Master (Pcs)
983-1	 table fork	210	2,5	983014	300
983-2	 table spoon	210	2,5	983021	300
983-5	 table knife	225	75gr	983052	120
983-14	 dessert fork	190	2,5	983144	300
983-15	 dessert spoon	190	2,5	983151	300
983-6	 dessert knife	205	62gr	983069	240
983-3	 tea spoon	140	2	983038	600
983-26	 mocca spoon	110	2	983267	600
983-4	 cake fork	140	2	983045	600
983-16	 fish fork	183	2,5	983168	300
983-17	 fish knife	198	2,5	983175	300





# Curve

eternum 964 2,5 mm 18 - 10 mirror

Article	Description	Length (mm)	Gage (mm)	EAN 13: 5413521+	Master (Pcs)
964-1	table fork	210	2,5	964013	300
964-2	table spoon	210	2,5	964020	300
964-5	table knife	225	75gr	964037	120
964-14	dessert fork	190	2,5	964143	300
964-15	dessert spoon	190	2,5	964051	300
964-6	dessert knife	205	62gr	964143	240
964-3	tea spoon	140	2	964150	600
964-26	mocca spoon	110	2	964167	600
964-4	cake fork	140	2	964174	600
964-16	fish fork	183	2,5	964068	300
964-17	fish knife	198	2,5	964266	300
964-7	soup ladle	220	3	964075	1
964-8	cake server	260	3	964082	1
964-10	salad server	231	3	964105	1
964-11	gravy ladle	138,5	2,5	964112	1
964-12	serving spoon	245	3	964122	1













# Baguette LM

eternum

2610

2,5 mm

18 - 10

Article	Description	Length (mm)	Gage (mm)	EAN 13: 5413521+	Master (Pcs)
2610-1	 table fork	208	2,5	261013	300
2610-2	 table spoon	208	2,5	261020	300
2610-5	 table knife mono	238	111 gr	261051	120
2610-14	 dessert fork	181	2	261143	300
2610-15	 dessert spoon	180	2	261150	300
2610-6	 dessert knife mono	212	84 gr	261068	120
2610-3	 tea spoon	135	2	261037	600
2610-26	 mocca spoon	112	1,8	261266	600
2610-4	 cake fork	143	2	261044	600
2610-16	 fish fork	174	2	261167	300
2610-17	 fish knife	195	2	261174	300
2610-33	 soup spoon	175	2	261334	300



Article	Description	Length (mm)	Gage (mm)	EAN 13: 5413521+	Master (Pcs)
1921-1	table fork	196	2,5	921016	300
1921-2	table spoon	195	2,5	921023	300
1921-5	table knife mono	210	98 gr	921054	120
1921-14	dessert fork	179	2	921146	300
1921-15	dessert spoon	181	2	921153	300
1921-6	dessert knife mono	188	69 gr	921061	240
1921-3	tea spoon	144	2	921030	600
1921-26	mocca spoon	118	1,8	921269	600
1921-4	cake fork	149	2	921047	600
1921-16	fish fork	181	2	921160	300
1921-17	fish knife	202	2	921177	300
1921-7	soup ladle	290	2,2	921078	1
1921-10	salad server	203	2,5	921108	1
1921-11	gravy ladle	174	2,5	921115	1
1921-12	serving spoon	208	2,2	921122	1



# Rivoli

eternum

1921 | 2,5 mm | 18 - 10



# Alfa

ADRIEN CIEJAK & PIERRE DUTHOIT

eternum

959 | 2,0 mm | 18 - 10

Article	Description	Length (mm)	Gage (mm)	EAN 13: 5413521+	Master (Pcs)
959-1	table fork	205	2	959019	300
959-2	table spoon	205	2	959026	300
959-5	table knife	225	74 gr	959057	240
959-3	tea spoon	140	1,8	959033	600

# Utah

eternum

973 | 2,5 mm | 18 - 10



# Elégance

eternum

966 | 2,5 mm | 18 - 10



Article	Description	Length (mm)	Gage (mm)	EAN 13: 5413521+	Master (Pcs)
1921-1	table fork	196	2,5	921016	300
1921-2	table spoon	195	2,5	921023	300
1921-5	table knife mono	210	98 gr	921054	120
1921-14	dessert fork	179	2	921146	300
1921-15	dessert spoon	181	2	921153	300
1921-6	dessert knife mono	188	69 gr	921061	240
1921-3	tea spoon	144	2	921030	600
1921-26	mocca spoon	118	1,8	921269	600
1921-4	cake fork	149	2	921047	600
1921-16	fish fork	181	2	921160	300
1921-17	fish knife	202	2	921177	300
1921-7	soup ladle	290	2,2	921078	1
1921-10	salad server	203	2,5	921108	1
1921-11	gravy ladle	174	2,5	921115	1
1921-12	serving spoon	208	2,2	921122	1

Article	Description	Length (mm)	Gage (mm)	EAN 13: 5413521+	Master (Pcs)
966-1	table fork	194	2,5	966017	300
966-2	table spoon	194	2,5	966024	300
966-5	table knife mono	218	69 gr	966055	300
966-14	dessert fork	175	2	966147	300
966-15	dessert spoon	177	2	966154	300
966-6	dessert knife mono	190	56 gr	966062	300
966-3	tea spoon	128	2	966031	600
966-26	mocca spoon	113	1,8	966260	600
966-4	cake fork	148	2	966048	600
966-16	fish fork	173	2,5	966161	300
966-17	fish knife	196	2,5	966178	300
966-7	soup ladle	303	2,5	966079	1
966-8	cake server	240	2,5	966086	1
966-9	chips server	222	2,5	966093	1
966-10	salad server	196	2,5	966109	1
966-11	gravy ladle	167	2,5	966116	1
966-12	serving spoon	227	2,5	966123	1



Article	Description	Length (mm)	Gage (mm)	EAN 13: 5413521+	Master (Pcs)
973-1	table fork	194	2,5	973015	300
973-2	table spoon	199	2,5	973022	300
973-5	table knife mono	215	90 gr	973053	120
973-14	dessert fork	177	2	973145	300
973-15	dessert spoon	175	2	973152	300
973-6	dessert knife mono	198	69 gr	973060	300
973-3	tea spoon	147	2	973039	600
973-26	mocca spoon	121	1,8	973268	600
973-4	cake fork	147	2	973046	600
973-45	steak knife	225	82 gr	973459	240
973-34	zakouski spoon	123	2	973343	1

Article	Description	Length (mm)	Gage (mm)	EAN 13: 5413521+	Master (Pcs)
1420-1	table fork	192	2,5	420014	300
1420-2	table spoon	194	2,5	420021	300
1420-5	table knife mono	213	66 gr	420052	300
1420-3	tea spoon	139	2	420038	600
1420-26	mocca spoon	115	1,7	420267	600
1420-4	cake fork	144	1,7	420045	600
1420-17	fish knife	210	2	420175	300
1420-33	soup spoon	177	2	420335	300
1420-34	zakouski spoon	125	2	420342	1
1420-7	soup ladle	311	2,8	420076	1
1420-8	cake server	25	2,5	420083	1
1420-9	chips server	250	2,5	420090	1
1420-10	salad server	205	3	420106	1
1420-11	gravy ladle	170	2,5	420113	1
1420-12	serving spoon	226	2,5	420120	1



# Lugano

eternum

324 | 2,2 mm | 18 - 10 | mirror



# Only

eternum

1420 | 2,5 mm | 18 - 10

# Rustic

eternum

8005 | Forged | 18



Article	Description	Length (mm)	Gage (mm)	EAN 13: 5413521+	Master (Pcs)
8005-1	table fork	199	-	805019	240
8005-2	table spoon	198	-	805026	240
8005-5	table knife mono	225	-	805057	240
8005-3	tea spoon	142	-	805033	300
8005-26	mocca spoon	112	-	805262	300
8005-4	cake fork	150	-	805040	300
8005-45	steak knife	225	-	805453	240





# Doria













eternum

8004 | forged | 18 - 0



Article	Description	Length (mm)	Gage (mm)	EAN 13: 5413521+	Master (Pcs)
8004-1	table fork	193	-	804012	240
8004-2	table spoon	193	-	804029	240
8004-5	table knife mono	211	63 gr	804050	240
8004-3	tea spoon	152	-	804036	300
8004-26	mocca spoon	125	-	804265	300
8004-4	cake fork	152	-	804043	300
8004-45	steak knife	209	58 gr	804456	240
8004-46	steak fork	192	-	804463	240
8004-8	cake server	255	-	804081	1
8004-11	gravy ladle	184	-	804111	1

Article	Description	Length (mm)	Gage (mm)	EAN 13: 5413521+	Master (Pcs)
2004-1	 table fork	200	2,3	240018	300
2004-2	 table spoon	200	2,3	240025	300
2004-3	 tea spoon	140	1,9	240032	300
2004-45	 steak knife	229	49 gr	240452	240

Article	Description	Length (mm)	Gage (mm)	EAN 13: 5413521+	Master (Pcs)
982-1	 table fork	204	2,5	982017	300
982-2	 table spoon	202	2,5	982024	300
982-5	 table knife mono	220	77 gr	982055	240
982-14	 dessert fork	185	2	982147	300
982-15	 dessert spoon	183	2	982154	300
982-6	 dessert knife mono	202	59 gr	982062	240
982-3	 tea spoon	140	1,8	982031	600
982-26	 mocca spoon	114	1,5	982260	600
982-4	 cake fork	140	1,8	982048	600
982-17	 fish knife	199	2	982178	300
982-40	 fruit/butter knife	159	41 gr	982406	300
982-10	 salad server	235	2,5	982109	1



# Trapez

eternum

2400 | ABS | 18 - 0



# Salsa

eternum

| 982 | 2,5 mm | 18 - 0













# Fjord

eternum

1900

2,5 mm

18 - 0

Article	Description	Length (mm)	Gage (mm)	EAN 13: 5413521+	Master (Pcs)
1900-1	 table fork	211	2,5	900011	300
1900-2	 table spoon	209	2,5	900028	300
1900-5	 table knife mono	235	71 gr	900059	120
1900-14	 dessert fork	186	1,8	900141	300
1900-15	 dessert spoon	185	1,8	900158	300
1900-6	 dessert knife mono	208	52 gr	900066	240
1900-3	 tea spoon	138	2	900035	600
1900-26	 mocca spoon	100	1	900264	1200
1900-17	 fish knife	211	1,8	900172	300
1900-25	 cocktail spoon	197	2	900257	300
1900-34	 zakouski spoon	120	1,8	900349	1
1900-10	 salad server	230	2,5	900103	1



Article	Description	Length (mm)	Gage (mm)	EAN 13: 5413521+	Master (Pcs)
1400-1	table fork	192	2,5	400016	300
1400-2	table spoon	193	2,5	400023	300
1400-5	table knife mono	212	66 gr	400054	300
1400-3	tea spoon	139	1,8	400030	600
1400-4	cake fork	142	2	400047	600
1400-17	fish knife	290	2	400177	300
1400-7	soup ladle	311	2,8	400078	1
1400-8	cake server	256	2,5	400085	1
1400-9	chips server	250	2,5	400092	1
1400-10	salad server	205	3	400108	1
1400-11	gravy ladle	170	2,5	400115	1
1400-12	serving spoon	226	2,5	400122	1



# Concorde

eternum

1400 | 2,5 mm | 18 - 0



# Ingres

eternum

1700 | 2,5 mm | 18 - 0

Article	Description	Length (mm)	Gage (mm)	EAN 13: 5413521+	Master (Pcs)
1700-1	table fork	209	2,5	170018	300
1700-2	table spoon	210	2,5	170025	300
1700-5	table knife mono	235	97 gr	170056	120
1700-14	dessert fork	184	2,5	170148	300
1700-15	dessert spoon	184	2,5	170155	300
1700-6	dessert knife mono	211	70 gr	170063	240
1700-3	tea spoon	144	2	170032	600
1700-26	mocca spoon	118	2	170261	600
1700-4	cake fork	148	2	170049	600
1700-16	fish fork	181	2,5	170162	300
1700-17	fish knife	194	2,5	170179	300
1700-25	cocktail spoon	195	2	170254	300
1700-19	oyster fork	134	2	170193	600
1700-20	snail fork	144	2	170209	600
1700-7	soup ladle	305	2,5	170070	1
1700-8	cake server	248	2,5	170087	1
1700-9	chips server	248	2,5	170094	1
1700-11	gravy ladle	169	2,5	170117	1
1700-12	serving spoon	233	2,5	170124	1

# Lipsi

eternum

2040 | 2,5 mm | 18 - 0



Article	Description	Length (mm)	Gage (mm)	EAN 13: 5413521+	Master (Pcs)
2040-1	table fork	206	2,5	204010	300
2040-2	table spoon	200	2,5	204027	300
2040-5	table knife mono	228	85 gr	204058	240
2040-14	dessert fork	190	2,5	204140	300
2040-15	dessert spoon	185	2,5	204157	300
2040-6	dessert knife mono	210	77 gr	204065	240
2040-3	tea spoon	141	2	204034	600
2040-26	mocca spoon	118	2	204263	600
2040-4	cake fork	150	2	204041	600
2040-16	fish fork	188	2,5	204164	300
2040-17	fish knife	199	2,5	204171	300
2040-8	cake server	251	2,5	204089	1
2040-9	chips server	247	2,5	204096	1
2040-11	gravy ladle	165	2,5	204119	1
2040-12	serving spoon	205	2,5	204126	1

# Opera

eternum

968 | 2,5 mm | 18 - 0



Article	Description	Length (mm)	Gage (mm)	EAN 13: 5413521+	Master (Pcs)
968-1	table fork	209	2,5	968011	300
968-2	table spoon	208	2,5	968028	300
968-5	table knife mono	233	81 gr	968059	240
968-14	dessert fork	186	2,5	968141	300
968-15	dessert spoon	185	2,5	968158	300
968-6	dessert knife mono	203	56 gr	968066	240
968-3	tea spoon	143	2	968035	600
968-26	mocca spoon	118	2	968264	600
968-4	cake fork	146	2	968042	600
968-16	fish fork	174	2,5	968165	300
968-17	fish knife	196	2,5	968172	300
968-45	steak knife	223	84 gr	968455	240



# Ecobaguette

eternum

2611 | 2,5 mm | 18 - 0



# Vieux-Paris

eternum

1300 | 2,5 mm | 18 - 0

Article	Description	Length (mm)	Gage (mm)	EAN 13: 5413521+	Master (Pcs)
2611-1	table fork	208	2,5	611016	300
2611-2	table spoon	208	2,5	611023	300
2610-5	table knife mono	238	90 gr	611054	120
2611-14	dessert fork	182	2	611146	300
2611-15	dessert spoon	180	2	611153	300
2610-6	dessert knife mono	212	62 gr	611061	120
2611-3	tea spoon	138	1,8	611030	600
2611-26	mocca spoon	111	1,8	611269	600
2611-4	cake fork	145	1,8	611047	600
2611-16	fish fork	174	2	611160	300
2611-17	fish knife	195	2	611177	300
2611-5	table knife mono	238	90 gr	611054	120
2611-6	dessert knife mono	212	62 gr	611061	120

Article	Description	Length (mm)	Gage (mm)	EAN 13: 5413521+	Master (Pcs)
1300-1	table fork	210	2,5	130012	300
1300-2	table spoon		-	130029	300
1300-5	table knife mono	231	87 gr	130050	240
1300-14	dessert fork	184	2,2	130142	300
1300-15	dessert spoon	182	2,2	130159	300
1300-6	dessert knife mono	210	68 gr	130067	240
1300-3	tea spoon	145	2	130036	600
1300-26	mocca spoon	117	2,2	130265	600
1300-16	fish fork	185	2,2	130166	300
1300-17	fish knife	198	2,2	130173	300
1300-25	cocktail spoon	193	2,5	130258	300

# Isabelle

eternum

2010 | 2,2 mm | 18 - 0



Article	Description	Length (mm)	Gage (mm)	EAN 13: 5413521+	Master (Pcs)
2010-1	table fork	205	2,2	201019	300
2010-2	table spoon	198	2,2	201026	300
2010-5	table knife mono	228	71 gr	201057	240
2010-14	dessert fork	195	2,2	201149	300
2010-15	dessert spoon	188	2,2	201156	300
2010-6	dessert knife mono	208	67 gr	201064	300
2010-3	tea spoon	142	1,8	201033	600
2010-4	cake fork	148	1,8	201040	600
2010-16	fish fork	191	2,2	201163	300
2010-17	fish knife	201	2,2	201170	300
2010-19	oyster fork	136	1,8	201194	600
2010-20	snail fork	141	1,8	201200	600
2010-8	cake server	262	2,5	201088	1
2010-9	chips server	254	2,5	201095	1
2010-10	salad server	196	2,2	201101	1
2010-11	gravy ladle	172	2,5	201118	1

# Aude

eternum

1922 | 2,2 mm | 18 - 0



Article	Description	Length (mm)	Gage (mm)	EAN 13: 5413521+	Master (Pcs)
1922-1	table fork	196	2,2	922013	300
1922-2	table spoon	198	2,2	922020	300
1922-5	table knife mono	230	81 gr	922051	240
1922-14	dessert fork	177	1,8	922143	300
1922-15	dessert spoon	178	1,8	922150	300
1922-6	dessert knife mono	202	60 gr	922068	300
1922-3	tea spoon	144	1,8	922037	600
1922-26	mocca spoon	116	1,5	922266	600
1922-4	cake fork	147	1,8	922044	600
1922-16	fish fork	180	1,8	922167	300
1922-17	fish knife	203	1,8	922174	300
1922-25	cocktail spoon	195	2	922259	300
1922-7	soup ladle	287	2	922075	1
1922-8	cake server	235	2	922082	1
1922-10	salad server	199	2	922105	1
1922-12	serving spoon	208	2	922129	1
1922-21	serving fork	200	2	922211	1



Article	Description	Length (mm)	Gage (mm)	EAN 13: 5413521+	Master (Pcs)
1790-1	table fork	197	2,2	790018	300
1790-2	table spoon	195	2,2	790025	300
1790-5	table knife mono	231	91 gr	790056	120
1790-14	dessert fork	190	2,2	790148	300
1790-15	dessert spoon	179	2,2	790155	300
1790-6	dessert knife mono	213	79 gr	790063	240
1790-3	tea spoon	138	1,8	790032	600
1790-26	mocca spoon	108	1,8	790261	600
1790-4	cake fork	144	1,8	790049	600
1790-16	fish fork	190	2,2	790162	300
1790-17	fish knife	199	2,2	790179	300
1790-25	cocktail spoon	189	1,8	790254	300
1790-19	oyster fork	132	1,8	790193	600
1790-20	snail fork	137	1,8	790209	600
1790-7	soup ladle	285	2,5	790070	1
1790-8	cake server	243	2,5	790087	1
1790-9	chips server	250	2,5	790094	1
1790-11	gravy ladle	180	2,5	790117	1



# Octo

eternum

1790 | 2,2 mm | 18 - 0

Article	Description	Length (mm)	Gage (mm)	EAN 13: 5413521+	Master (Pcs)
1721-1	table fork	207	2	721012	300
1721-2	table spoon	205	2	721029	300
1721-3	tea spoon	147	1,2	721036	600
1721-26	mocca spoon	110	1	721265	600
1721-45	steak knife	229	64 gr	721456	240
1721-25	cocktail spoon	200	2	721258	300



# Diva

eternum

1721 | 2,0 mm | 18 - 0

# Frida

eternum

958

2,2 mm

18-0



Article	Description	Length (mm)	Gage (mm)	EAN 13: 5413521+	Master (Pcs)
958-1	table fork	201	2,2	958012	300
958-2	table spoon	194	2	958029	300
958-5S	table knife mono	227	64 gr	958050	300
958-14	dessert fork	166	2	958142	300
958-15	dessert spoon	168	2	958159	300
958-6S	dessert knife mono	194	40 gr	958067	300
958-3	tea spoon	135	1,8	958036	600
958-26	mocca spoon	121	1,8	958265	600
958-4	cake fork	143	1,8	958043	600
958-16	fish fork	196	2	958166	300
958-17	fish knife	205	2	958173	300
958-45	steak knife	233	61 gr	958456	300
958-25	cocktail spoon	199	1,8	958258	300
958-18	icecream spoon	137	1,8	958180	600
958-19	oyster fork	135	1,8	958197	600
958-20	snail fork	143	1,8	958203	600
958-7	soup ladle	310	2,8	958074	1
958-8	cake server	250	2,5	958081	1
958-9	chips server	250	2,5	958098	1
958-10	salad server	195	2	958104	1
958-11	gravy ladle	162	2,5	958111	1
958-12	serving spoon	246	2,5	958128	1
958-21	serving fork	208	2	958210	1
958-27B	butter knife mono	170	2	958272	1
958-39	zakouski fork	117	1,8	958395	600



# New Carmen

eternum

315 | 2,0 mm | 18 - 0

Article	Description	Length (mm)	Gage (mm)	EAN 13: 5413521+	Master (Pcs)
315-1	table fork	189	2	315013	300
315-2	table spoon	188	2	315020	300
315-5	table knife mono	210	57 gr	315051	300
315-3	tea spoon	134	1,5	315037	600
315-26	mocca spoon	114	1,5	315266	600
315-4	cake fork	137	1,5	315044	600
315-25	cocktail spoon	173	1,5	315259	300



# Verona

eternum

319 | 2,2 mm | 18 - 0

Article	Description	Length (mm)	Gage (mm)	EAN 13: 5413521+	Master (Pcs)
319-1	table fork	197	2,2	319011	300
319-2	table spoon	189	2	319028	300
319-5	table knife mono	212	62 gr	319059	240
319-3	tea spoon	133	1,5	319035	600
319-26	mocca spoon	108	1,5	319264	600
319-14	dessert fork	173	1,8	319141	300
319-15	dessert spoon	174	1,8	319158	300
319-6	dessert knife	195	34gr	319066	300





Tumble polish with additional side polish

# Modena

eternum 

957 | 2,0 mm | 18 - 0



Article	Description	Length (mm)	Gage (mm)	EAN 13: 5413521+	Master (Pcs)
957-1	 table fork	189	2	957015	300
957-2	 table spoon	186	1,8	957022	300
957-5	 table knife mono	211	40 gr	957053	300
957-3	 tea spoon	137	1,5	957039	600
957-26	 mocca spoon	115	1,2	957268	600







Tumble polish

# Vesuve

eternum 

951 | 2,0 mm | 18 - 0



Article	Description	Length (mm)	Gage (mm)	EAN 13: 5413521+	Master (Pcs)
951-1	 table fork	186	2	951013	300
951-2	 table spoon	188	1,8	951020	300
951-5	 table knife mono	209	40 gr	951051	300
951-3	 tea spoon	137	1,5	951037	600
951-26	 mocca spoon	113	1,5	951266	600
951-4	 cake fork	143	1,5	951044	600
951-25	 cocktail spoon	199	1,5	951259	300

Tumble polish

# gastro☕num



*Nedda*

Nedda



Coffee / Tea

65

77



Serving plates

67

81



Tableware

68

82



Bar

72

86



Special cutlery

75

87

Gastronomy Luxury	Catering Casual
63	-
65	77
67	81
68	82
72	86
75	87

# How to read the data?

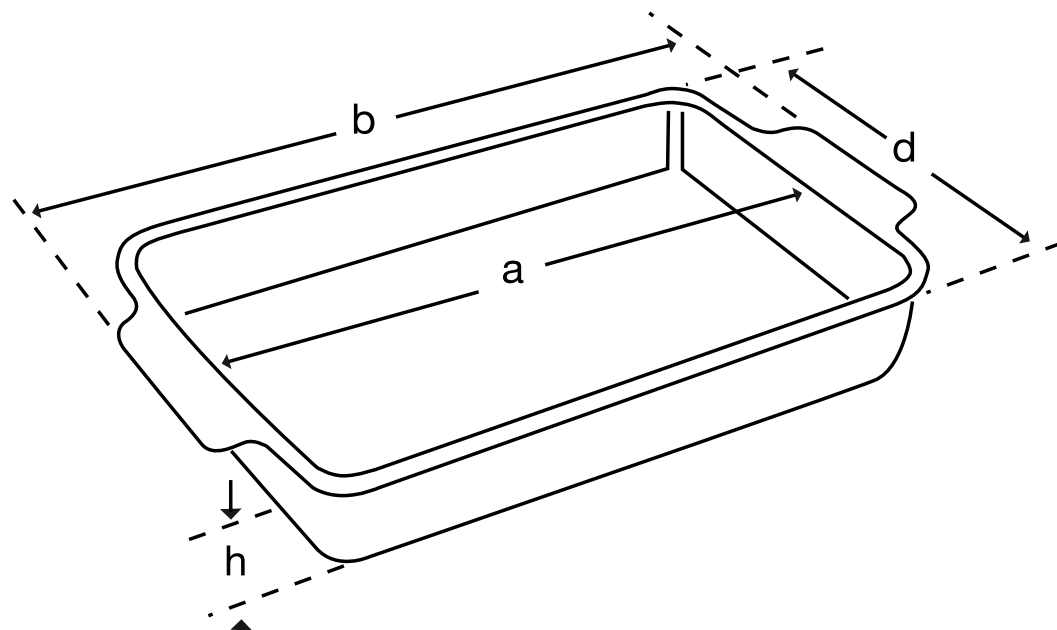

## Code

**a (mm)** = interior length  
longueur intérieure  
binnenlengte  
Innenmass  
lunghezza interna  
longitud interior  
**długość wewnętrzna**  
**внутренняя длина**  
**εσωτερικό μήκος**

**b (mm)** = exterior length  
longueur extérieure  
buitenlengte  
Aussenmass  
lunghezza esterna  
longitud exterior  
**długość zewnętrzna**  
**внешняя длина**  
**εξωτερικό μήκος**

**d (mm)** = width  
largeur  
breedte  
Breite  
larghezza  
anchura  
**szerokość**  
**ширина**  
**πλάτος**

**h (mm)** = height  
hauteur  
hoogte  
Höhe  
altezza  
altura  
**wysokość**  
**высота**  
**ύψος**

**i (cl)** = capacity  
capacité  
inhoud  
Inhalt  
capacità  
capacidad  
**pojemność**  
**вместимость**  
**χωρητικότητα**

**e (mm)** = thickness  
épaisseur  
dikte  
Materialstärke  
spessore  
espesor  
**grubość**  
**толщина**  
**πάχος**



## Champagne Bucket

Seau à champagne • Champagnekoeler • Sektkühler • Secchiello per champagne • Cubo de champán • Wiaderko na szampiana • Ведёрко для шампанского • Σαμπανιέρα

Ref	Int. length (a)	Ext. length (b)	Width (d)	Height (h)	Capacity (i)	Thickness (e)	gr	Master (Pcs)	Steel	EAN 5413521+
7908	171	213	212	206	0	1,3	1650	8	18/10	079083

## Tea pot

Théière • Theepot • Teekanne • Teiera • Tetera • Czajniczek do herbaty • Чайник • Τσαγιέρα

Ref	Int. length (a)	Ext. length (b)	Width (d)	Height (h)	Capacity (i)	Thickness (e)	gr	Master (Pcs)	Steel	EAN 5413521+
7340	72	176	107	75	40	0,8	396	32	18/10	073401
7240	72	181	107	75	40	0,8	396	32	18/10	072404



## Round Tray

Plateau Rond • Ronde Schaal • rundes Tablett • Vassoio Rotondo • Bandeja Redonda • Τάσα οκράγα • Круглый поднос • Στρογγυλός δίσκος

Ref	Int. length (a)	Ext. length (b)	Width (d)	Height (h)	Capacity (i)	Thickness (e)	gr	Master (Pcs)	Steel	EAN 5413521+
7835	320	350	350	24	0	1	1266	9	18/10	078352

# Coffee Pot / Tea Pot

Cafetière • Koffiepot • Kaffeekanne • Caffettiera • Cafetera •  
Czajniczek do kawy • Кофейник • Καφετιέρα

Ref	Int. length (a)	Ext. length (b)	Width (d)	Height (h)	Capacity (i)	Thickness (e)	gr	Master (Pcs)	Steel	EAN 5413521+
7060	71	175	114	114	60	1	505	20	18/10	070608
7035	62	98	77	97	35	1	355	40	18/10	070356



# Milk Jug

Crémier • Melkpot • Milchkanne • Bricchetto per panna • Casaro Lechera •  
Dzbanek na śmietankę • Кувшинчик для сливок • Σκεύος κρέμας γάλακτος

Ref	Int. length (a)	Ext. length (b)	Width (d)	Height (h)	Capacity (i)	Thickness (e)	gr	Master (Pcs)	Steel	EAN 5413521+
7435	62	154	98	86	35	1	297	40	18/10	074354
7415	50	76	72	66	15	0,8	115	80	18/10	074156

# Sugar Bowl

Sucrier • Suikerpot • Zuckerdose • Zuccheriera • Azucarero •  
Cukiernica • Сахарница • Ζαχαριέρα

Ref	Int. length (a)	Ext. length (b)	Width (d)	Height (h)	Capacity (i)	Thickness (e)	gr	Master (Pcs)	Steel	EAN 5413521+
7615	50	72	61	66	15	0,8	117	64	18/10	076150







## Coffee pot "classic"

Cafetière • Koffiepot • Kaffeekanne • Caffettiera • Cafetera •  
Czajniczek do kawy • Кофейник • Кафетієра

Ref	Int. length (a)	Ext. length (b)	Width (d)	Height (h)	Capacity (i)	Thickness (e)	gr	Master (Pcs)	Steel	EAN 5413521+
6035	58			145	35	1,3	328	36	18/10	060357
6050	65			168	50	1,5	443	24	18/10	060500
6090	77			190	90	1,5	592	12	18/10	060906
6160	95			230	160	1,5	860	12	18/10	061606

## Tea pot "classic"

Cafetière • Koffiepot • Kaffeekanne • Caffettiera • Cafetera •  
Czajniczek do kawy • Кофейник • Кафетієра

Ref	Int. length (a)	Ext. length (b)	Width (d)	Height (h)	Capacity (i)	Thickness (e)	gr	Master (Pcs)	Steel	EAN 5413521+
6235	65			128	35	1,3	347	36	18/10	062351
6260	76			148	60	1,5	478	24	18/10	062603



## Milk jug "classic"

Cafetière • Koffiepot • Kaffeekanne • Caffettiera • Cafetera •  
Czajniczek do kawy • Кофейник • Кафетієра



Ref	Int. length (a)	Ext. length (b)	Width (d)	Height (h)	Capacity (i)	Thickness (e)	gr	Master (Pcs)	Steel	EAN 5413521+
6423	62			90	23	1,0	171	48	18/10	064232
6435	58			117	35	1,3	275	36	18/10	064355
6460	65			137	60	1,5	366	24	18/10	064607

## Sugar pot "classic"

Sucrier • Suikerpot • Zuckerdose • Zuccheriera • Azucarero •  
Cukiernica • Сахарница • Ζαχαριέρα

Ref	Int. length (a)	Ext. length (b)	Width (d)	Height (h)	Capacity (i)	Thickness (e)	gr	Master (Pcs)	Steel	EAN 5413521+
6628	68			115	28	1,0	279	48	18/10	066281



## Coffee pot "luxe"

Cafetière • Koffiepot • Kaffeekanne • Caffettiera • Cafetera •  
Czajniczek do kawy • Кофейник • Καφετιέρα

Ref	Int. length (a)	Ext. length (b)	Width (d)	Height (h)	Capacity (i)	Thickness (e)	gr	Master (Pcs)	Steel	EAN 5413521+
4035	57			100	35	1,0	308	48	18/10	040359
4060	68			119	60	1,0	423	40	18/10	040601
4100	81			148	100	1,0	682	20	18/10	041004
4180	100			180	180	1,0	852	12	18/10	041806

## Milk jug "luxe"

Crémier • Melkpot • Milchkanne • Bricchetto per panna •  
Casaro Lechera • Dzbaneek na śmietankę • Кувшинчик для  
сливок • Σκεύος κρέμας γάλακτος

Ref	Int. length (a)	Ext. length (b)	Width (d)	Height (h)	Capacity (i)	Thickness (e)	gr	Master (Pcs)	Steel	EAN 5413521+
4415	48			64	15	1,0	116	12/144	18/10	044159
4435	65			84	35	1,0	262	12/72	18/10	044357





## Tea pot "luxe"

Théière • Theepot • Teekanne • Teiera • Tetera •  
Czajniczek do herbaty • Чайник • Τσαγιέρα

Ref	Int. length (a)	Ext. length (b)	Width (d)	Height (h)	Capacity (l)	Thickness (e)	gr	Master (Pcs)	Steel	EAN 5413521+
4235	69			90	35	1,0	340	36	18/10	042353
4260	81			100	60	1,0	418	24	18/10	042605

## Round tray

Plateau Rond • Ronde Schaal • rundes Tablett • Vassoio Rotondo • Bandeja Redonda •  
Τασα οκράγα • Круглый поднос • Στρογγυλός δίσκος

Ref	Int. length (a)	Ext. length (b)	Width (d)	Height (h)	Capacity (l)	Thickness (e)	gr	Master (Pcs)	Steel	EAN 5413521+
230	250	300		21		1,0	560	10/40	18/10	002302
237	310	370		21		1,0	920	10/20	18/10	002371
241	355	410		21		1,0	1500	5/15	18/10	002418



# Rectangular tray

Plateau Rectangulaire • Rechthoekige Schaal • Rechteckiges Tablett • Vassaoio rettangolare • Bandeja Rectangular • Таса прoтoкaтнa • Прямоугольный Поднос • οσθoγώνιος δίσκος

Ref	Int. length (a)	Ext. length (b)	Width (d)	Height (h)	Capacity (i)	Thickness (e)	gr	Master (Pcs)	Steel	EAN 5413521+
325	215	252	196	16	0	1,0	376	10/40	18/10	003255
331	245	311	238	21	0	1,0	614	10/20	18/10	003316
337	315	370	270	23	0	1,0	840	10/20	18/10	003378
341	333	412	315	23	0	1,2	1280	5/10	18/10	003415
346	373	463	356	23	0	1,2	1600	4/8	18/10	003460
351	425	510	390	23	23	1,2	2000	4/8	18/10	003514

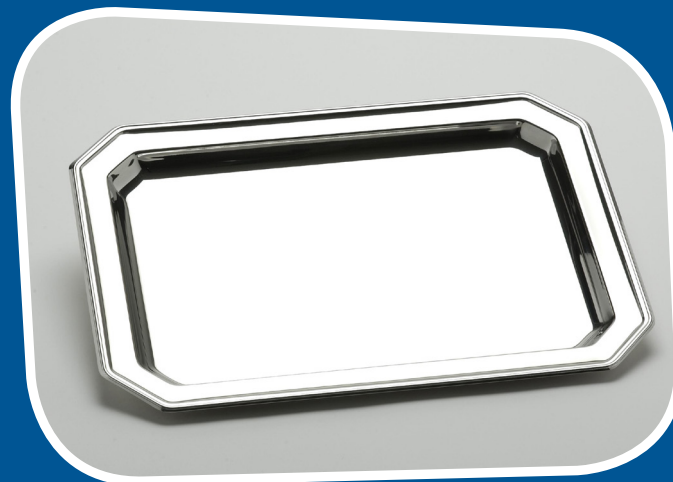

# Butter dish

Beurrier • Boterschaal • Butterschale • Portaburro • Mantequera • Pojemnik na maslo • Маслѐнка • Βουτυριέρα

Ref	Int. length (a)	Ext. length (b)	Width (d)	Height (h)	Capacity (i)	Thickness (e)	gr	Master (Pcs)	Steel	EAN 5413521+
507	57	90		75		1,0	208	1/54	18/10	005075

# Gravy boat

Saucière • Sauskom • Sauciere • Salsiera • Salsera • Sosjerka • Соусник • -Σαλτσιέρα

Ref	Int. length (a)	Ext. length (b)	Width (d)	Height (h)	Capacity (i)	Thickness (e)	gr	Master (Pcs)	Steel	EAN 5413521+
306		157	73	87	15	1,0	140	12/96	18/10	003064
303		192	82	96	30	1,0	210	12/72	18/10	003033





## Dome cover

Cloche de table • Tafelklok • Speisehauben • Coprivivande • Campana de mesa •  
Klosz do przykrywania potraw • баранчик • Θόλος καλύψεως

Ref	Int. length (a)	Ext. length (b)	Width (d)	Height (h)	Capacity (i)	Thickness (e)	gr	Master (Pcs)	Steel	EAN 5413521+
522	218	228				1,5	800	5/20	18/10	005228
524	240	255				1,5	960	5/20	18/10	005242
526	255	265				1,5	1020	5/20	18/10	005266

## Dome cover

Cloche de table • Tafelklok • Speisehauben • Coprivivande • Campana de mesa •  
Klosz do przykrywania potraw • баранчик • Θόλος καλύψεως

Ref	Int. length (a)	Ext. length (b)	Width (d)	Height (h)	Capacity (i)	Thickness (e)	gr	Master (Pcs)	Steel
522M	218	228				1,5	800	5/20	18/10
524M	240	255				1,5	960	5/20	18/10
526M	255	265				1,5	1020	5/20	18/10



## Buffet spoon



Ref	Int. length (a)	Ext. length (b)	Width (d)	Height (h)	Capacity (i)	Thickness (e)	gr	Master (Pcs)	Steel	EAN 5413521+
3040-10c		290				3,5		120	18/10	340138

# Finger bowl

Rince-doigts • Vingerkom • Fingerschale • Ciotola lava-dita • Lavadedos •  
Miseczka do mycia palców • Миска для ополаскивания пальцев •  
Μπολ χεριών

Ref	Int. length (a)	Ext. length (b)	Width (d)	Height (h)	Capacity (i)	Thickness (e)	gr	Master (Pcs)	Steel	EAN 5413521+
580		110		35	25	1,5	134	10/100	18/10	005808



# Ice cream cup

Coupe à glace • Ijsbeker • Eisbecher • Coppetta da gelato • Copa helado •  
Pucharek do lodów • Вазочка для мороженого • Κούπα παγωτού

Ref	Int. length (a)	Ext. length (b)	Width (d)	Height (h)	Capacity (i)	Thickness (e)	gr	Master (Pcs)	Steel	EAN 5413521+
3020	106			87	20	1,5	183	10/80	18/10	030206

# Napkin rings (set of 4)

Ronds de serviette • Serviettenring • Serviettenring •  
Portatovaglioli • Anillos de servilleta • Pierścienie na serwetki •  
Кольца для салфеток (4 шт.) • δαχτυλίδια πετσέτας

Ref	Int. length (a)	Ext. length (b)	Width (d)	Height (h)	Capacity (i)	Thickness (e)	gr	Master (Pcs)	Steel	EAN 5413521+
15924		50	39			1,0	160	24	18/10	159242



# Snail dish

Plat à escargots • Slakkenschotel • Schneckensteller • Piatto per lumache • Fuente para caracoles • Talerz na ślimaki • блюдо для улиток • Πιάτο σαλιγκαριών



Ref	Int. length (a)	Ext. length (b)	Width (d)	Height (h)	Capacity (i)	Thickness (e)	gr	Master (Pcs)	Steel	EAN 5413521+
406	125	172		10		0,8	182	12/72	18/10	004061
412	165	230		10		0,8	204	12/72	18/10	004122

# Snail tong

Pince à escargot • Slakkentang • Schneckenzange • Pinza per lumache • Pinza caracoles • Szczypce Do Ślimaków • Щипцы для улиток • Πιάτο σαλιγκαριών



Ref	Int. length (a)	Ext. length (b)	Width (d)	Height (h)	Capacity (i)	Thickness (e)	gr	Master (Pcs)	Steel	EAN 5413521+
2946							42	12/240	18/10	029460



# Lobster Cracker

Pince à homard • Kreeftenschaar • Hummerschere • Pinza per aragosta • Kinza bogavante • Szczypce do homarów • Щипцы для омара • Σπαστήρας αστακού

Ref	Int. length (a)	Ext. length (b)	Width (d)	Height (h)	Capacity (i)	Thickness (e)	gr	Master (Pcs)	Steel	EAN 5413521+
3011	180						132	12/288	18 Cr	030114

# Champagne bucket

Seau à champagne • Champagnekoeler • Sektkühler • Secchiello per champagne • Cubo de champán • Wiaderko na szampana • Ведёрко для шампанского • Σαμπανιέρα

Ref	Int. length (a)	Ext. length (b)	Width (d)	Height (h)	Capacity (i)	Thickness (e)	gr	Master (Pcs)	Steel	EAN 5413521+
2908	213			210	600	0,9	1100	4	14/1	029088



# Champagne bucket stand

Pied pour seau • Voet voor koeler • Ständer für Kühler • Base per secchiello champagne • Pie de champanero • Podstawka pod wiaderko do szampana • Подставка для ведра для шампанского • Πόδι σαμπανιέρας

Ref	Int. length (a)	Ext. length (b)	Width (d)	Height (h)	Capacity (i)	Thickness (e)	gr	Master (Pcs)	Steel	EAN 5413521+
2900	180	218	300	595		1,0	2150	4	18 Cr	029002

# Ice bucket

Seau à glace • Ijsemmer • Eiskühler • Secchiello per il ghiaccio • Cubo de hielo • Wiaderko na lód • Ведерко для льда • Παγωνιέρα

Ref	Int. length (a)	Ext. length (b)	Width (d)	Height (h)	Capacity (i)	Thickness (e)	gr	Master (Pcs)	Steel	EAN 5413521+
2910	107	125		120	100	1,0	392	30	18/10	029101







## Coaster (set of 2)

Sous-bouteille • Onderzetter • Untersetzer • Sotto • Posa •  
Podstawka - Подставки для стакана и бутылки • Σουβέρ

Ref	Int. length (a)	Ext. length (b)	Width (d)	Height (h)	Capacity (i)	Thickness (e)	gr	Master (Pcs)	Steel	EAN 5413521+	EAN 5413521+
for bottle	15920	85	113		10		0,6	120	12/72		159204

## Crum scoop

Ramasse-miettes • Kruimeldief • Tischbesen • Togli briciole - Recogemigas •  
Zestaw do okruszków • Скребок для уборки стола • Εργαλείο απομάκρυνσης ψίχουλων

Ref	Int. length (a)	Ext. length (b)	Width (d)	Height (h)	Capacity (i)	Thickness (e)	gr	Master (Pcs)	Steel	EAN 5413521+
770		152	29			1,0	39	12/600	18/10	007703



# Ice tong

Pince à glace • Ijstang • Eiszange • Pinza da ghiaccio • Pinza hielo •  
Szczyrce do lodu • Щипцы для льда • Λαβίδα πάγου

Ref	Int. length (a)	Ext. length (b)	Width (d)	Height (h)	Capacity (i)	Thickness (e)	gr	Master (Pcs)	Steel	EAN 5413521+
2927	180					1,0	45	60/240	18 Cr	029279



# Shaker

Shaker • Shaker • Shaker • Shaker • Coctelera • Шокер • Шейкер • Σέικερ

Ref	Int. length (a)	Ext. length (b)	Width (d)	Height (h)	Capacity (i)	Thickness (e)	gr	Master (Pcs)	Steel	EAN 5413521+
2912				240	70		430	48	18/10	029125

# Liqueur ladle

Louche à liqueur • Likeurlepel • Likörleffel • Mestolo per liquore  
• Cucharón de licor • Chocheika do likieru • Ложка для соуса/  
ликера • Κουτάλα λικέρ

Ref	Int. length (a)	Ext. length (b)	Width (d)	Height (h)	Capacity (i)	Thickness (e)	gr	Master (Pcs)	Steel	EAN 5413521+
780		300				4,0	60	100	18/10	007802





## Zakouski spoon

Cuillère zakouski • Zakouskilepel • Zakouskilöffel • Cucchiaio zakouski • Cuchara zakouski • Łyżka do zakąsek • Ложка для закусок • Κουτάλι ορεκτικών «Zakouski»

	Length (mm)	Gage (mm)	Master (Pcs)	Steel	EAN : 5413521+
1920-34	117	2,5	300	18/10	920347

## Steak knife - Forged - Professional Steel

	Length (mm)	Gage (mm)	Master (Pcs)	Steel	EAN : 5413521+
773	231	-	6/120	X50Cr-MoV15	007734



## Steak knife & fork laminated wood

Couteau steak • Steakmes • Steakmesser • Coltello da bistecca • Cuchillo de carne • Nóż do steków • Нож для стейка • Μαχαίρι Μπριζόλας

Fourchette steak • Steakvork • Steakgabel • Forchetta da bistecca • Tenedor de carne • Widelec do steków • Вилка для стейка • Πιρούνι μπριζόλας



	Length (mm)	Gage (mm)	Master (Pcs)	Steel	EAN : 5413521+
764	225	-	12	13/0	007642
	Length (mm)	Gage (mm)	Master (Pcs)	Steel	EAN : 5413521+
766	225	-	12	18/10	007666

## Steak knife "pistol"

Couteau steak • Steakmes • Steakmesser • Coltello da bistecca • Cuchillo de carne •  
Nóż do steków • Нож для стейка • Μαχαίρι Μπριζόλας

	Length (mm)	Gage (mm)	Master (Pcs)	Steel	EAN : 5413521+
999-45	233	-	12/240	18/10 + 13/0	999459



## Lobster fork

Curette à homard • Kreeftvork • Hummergabel • Forchetta per  
aragosta • Tenedor bogavante • Widelec do homarów •  
Вилочка для омара • Προύνη αστακού

Ref	Length (mm)	Gage (mm)	Master (Pcs)	Steel	EAN : 5413521+
782	204	2,5	12/300	18/10	007826
781	190	2,0	12/300	18/10	007819



## Spaghetti cutlery

Couverts spaghetti • Spaghettesteck • Spaghettesteck • Posateria spaghetti • Cub. espaguetis •  
Sztućce do spaghetti • Столовые приборы для спагетти • Μαχαροπήρουνα μακαρονιών

	Length (mm)	Gage (mm)	Master (Pcs)	Steel	EAN : 5413521+
2080-35	219	3,5	12/300	18/10	208353
2080-36	215	3,5	12/300	18/10	208360



# Coffee pot

Cafetière • Koffiepot • Kaffeekanne • Caffettiera • Cafetera •  
Czajniczek do kawy • Кофейник • Кафетієр



Ref	Int. length (a)	Ext. length (b)	Width (d)	Height (h)	Capacity (l)	Thickness (e)	gr	Master (Pcs)	Steel	EAN 5413521+
9-212	65			110	35	1,0	186	60	18/10	092129
9-208	78			130	60	1,0	291	36	18/10	092082
9-206	90			150	100	1,0	440	24	18/10	092068
9-203	100			190	150	1,0	566	24	18/10	092037
9-217	110			210	200	1,0	651	12	18/10	092174

# Tea pot

Théière • Theepot • Teekanne • Teiera • Tetera •  
Czajniczek do herbaty • Чайник • Тσαγιέρα



Ref	Int. length (a)	Ext. length (b)	Width (d)	Height (h)	Capacity (l)	Thickness (e)	gr	Master (Pcs)	Steel	EAN 5413521+
9-213	74			107	35	1,0	186	60	18/10	092136
9-209	87			112	60	1,0	291	36	18/10	092099

# Coffee pot "long spout"

Cafetière • Koffiepot • Kaffeekanne • Caffettiera • Cafetera •  
Czajniczek do kawy • Кофейник • Кафетієра



Ref	Int. length (a)	Ext. length (b)	Width (d)	Height (h)	Capacity (l)	Thickness (e)	gr	Master (Pcs)	Steel	EAN 5413521+
9-231P	65			110	35	1,0	208	12/48	18/10	092310
9-232P	78			130	60	1,0	337	6/36	18/10	092327
9-233P	90			150	100	1,0	404	30	18/10	092334
9-234P	100			190	150	1,0	647	12	18/10	092341
9-235P	110			210	200	1,0	700	12	18/10	092358

## Tea pot "long spout"

Théière • Theepot • Teekanne • Teiera • Tetera • Czajniczek do herbaty • Чайник • Τσαγιέρα

Ref	Int. length (a)	Ext. length (b)	Width (d)	Height (h)	Capacity (i)	Thickness (e)	gr	Master (Pcs)	Steel	EAN 5413521+
9-236P	74			107	35	1,0	208	12/48	18/10	092365
9-237P	87			112	60	1,0	337	6/48	18/10	092372



## Milk jug

Crémier • Melkpot • Milchkanne • Bricchetto per panna • Lechera • Dzbaneł na śmietankę • Кувшинчик для сливок • Σκεύος κρέμας γάλακτος

Ref	Int. length (a)	Ext. length (b)	Width (d)	Height (h)	Capacity (i)	Thickness (e)	gr	Master (Pcs)	Steel	EAN 5413521+
9-240	53			60	15	0,8	74	100	18/10	092402
9-214	65			90	35	1,0	132	60	18/10	092143
9-210	78			105	60	1,0	209	36	18/10	092105
9-205	90			125	100	1,0	278	24	18/10	092051
9-204	100			165	150	1,0	494	24	18/10	092044

## Jug with ice guard

Cruche • Kruik • Krug • Brocca • Jarra • Dzbaneł • Кувшин • Κανάτα

Ref	Int. length (a)	Ext. length (b)	Width (d)	Height (h)	Capacity (i)	Thickness (e)	gr	Master (Pcs)	Steel	EAN 5413521+
9-219	110			180	200	1,0	550	12	18/10	092198





## Sugar pot

Sucrier • Suikerpot • Zuckerdose • Zuccheriera • Azucarero •  
CukierNICA • Сахарница • Ζαχαριέρα

Ref	Int. length (a)	Ext. length (b)	Width (d)	Height (h)	Capacity (i)	Thickness (e)	gr	Master (Pcs)	Steel	EAN 5413521+
898	94			85	35	0,7	218	10/80	18/10	008984
9-201L	87			70	23	0,7	143	24/144	18/10	092013

## Milk jug

Crémier • Melkpot • Milchkanne • Bricchetto per panna • Lechera • DzbaneK na śmietankę •  
Кувшинчик для сливок • Σκεύος κρέμας γάλακτος

Ref	Int. length (a)	Ext. length (b)	Width (d)	Height (h)	Capacity (i)	Thickness (e)	gr	Master (Pcs)	Steel	EAN 5413521+
2400PO.03					3	0,6	15	10/240	18/10	024007
2400PO.10					10	0,6	33	10/200	18/10	240001



## Sugar tong

Pince à sucre • Suikertang • Zuckerzange • Molla zucchero •  
Pinzas de azúcar • Szczypce do cukru • Щипчики для сахара •  
Λαβίδα Ζάχαρης



Ref	Int. length (a)	Ext. length (b)	Width (d)	Height (h)	Capacity (i)	Thickness (e)	gr	Master (Pcs)	Steel	EAN 5413521+
940-13		122	18			1	23	300		940130

## Tea infuser

Cuillère à thé • Theelepел • Teelöffel • Infusore per tè • Cuchara para té •  
 łyżeczka do herbaty • Ложка для заваривания чая • Συσκευή διήθησης  
 τσαγιού

Ref	Int. length (a)	Ext. length (b)	Width (d)	Height (h)	Capacity (i)	Thickness (e)	gr	Master (Pcs)	Steel	EAN 5413521+
3116		150				0,5	38	24	18/10	031166



## Lemon squeezer

Presse-citrons • Citroenpers • Zitronenpresse • Spremiagrami • Exprimelimonas •  
 Wyciskacz do cytryn • Соковыжималка для лимона • Λεμονοστύφτης

Ref	Int. length (a)	Ext. length (b)	Width (d)	Height (h)	Capacity (i)	Thickness (e)	gr	Master (Pcs)	Steel	EAN 5413521+
2928		80	50	34			34	12/600	18/10	029286

## Vegetable bowl

Légumier • Groentenschotel • Gemüseschale • Insalatiera •  
 Plato de verduras • Naczynie do serwowania warzyw •  
 Салатница • Μπολ λαχανικών

Ref	Int. length (a)	Ext. length (b)	Width (d)	Height (h)	Capacity (i)	Thickness (e)	gr	Master (Pcs)	Steel	EAN 5413521+
112	125	145		50	40	0,7	81	12/240	18/10	001121







## Rond de serviette

Ref	Master	Steel	EAN : 5413521+
41208	12/240	18/10	412088

## Serving tray

Plateau de service • Serveerschotel • Serviertablett • Vassoio da portata • Bandeja • Таса • Раздаточный поднос • Δίσκος σερβιρίσματος



Ref	Int. length (a)	Ext. length (b)	Width (d)	Height (h)	Capacity (i)	Thickness (e)	gr	Master (Pcs)	Steel	EAN 5413521+
540	350	400		32		0,5	500	24	14/1	005402

## Condiment sets

Sets à condiments • Kruiden sets • Gewürzsets • Set per condimenti • Servicio de condimentos • Zestaw do przypraw • Наборы для специй • Σετ αρτιμάτων



Ref	Int. length (a)	Ext. length (b)	Width (d)	Height (h)	Capacity (i)	Thickness (e)	gr	Master (Pcs)	Steel	EAN 5413521+	EAN 5413521+
salt - pepper - mustard	566/758		82	77	130			340	60	18 Cr	566583
oil - vinegar	566/761		52	112	215			560	12/48	18 Cr	566613
salt - pepper	566/768		36	77	130			215	12/72	18 Cr	566682

# Butter dish

Beurrier • Boterschaal • Butterschale • Portaburro • Mantequera •  
Pojemnik na masł • Маслѣнка • Βουτιριέρα

Ref	Int. length (a)	Ext. length (b)	Width (d)	Height (h)	Capacity (i)	Thickness (e)	gr	Master (Pcs)	Steel	EAN 5413521+
508	55	90		75		0,6	208	54	18/10	005082



# Soup bowl

Bol à potage • Soepkom • Suppenschale • Zuppiera • Sopa de contenedores •  
Mieszka Na Zupę • Миска для супа • Μπολ σούπας

Ref	Int. length (a)	Ext. length (b)	Width (d)	Height (h)	Capacity (i)	Thickness (e)	gr	Master (Pcs)	Steel	EAN 5413521+
730	130	150		65	45	1,0	161	10/100	18/10	007307
730-E	130	150		65	45	1,0	169	10/100	14/1	300071

# Gravy boat

Saucière • Sauskom • Sauciere • Salsiera • Salsera •  
Sosjerka • Соусник • Σαλτσιέρα

Ref	Int. length (a)	Ext. length (b)	Width (d)	Height (h)	Capacity (i)	Thickness (e)	gr	Master (Pcs)	Steel	EAN 5413521+
401		190	87	52	22	0,7	79	24/192	18/10	004016



# Gravy boat

Saucière • Sauskom • Sauciere • Salsiera • Salsera • Sosjerka • Соусник • Σαλτατέρα



Ref	Int. length (a)	Ext. length (b)	Width (d)	Height (h)	Capacity (i)	Thickness (e)	gr	Master (Pcs)	Steel	EAN 5413521+
1514		170	75	78	14	0,7	137	12/96	18/10	015142
1522		220	95	90	22	0,7	380	10/60	14/1	015227

# Bowl

Ramequin • Schaaltje • Schale • Ciotola • Ramekin • Miseczka • Миска/ салатник • Мпол



Ref	Int. length (a)	Ext. length (b)	Width (d)	Height (h)	Capacity (i)	Thickness (e)	gr	Master (Pcs)	Steel	EAN 5413521+
2940		100		40	15 cl	1,0	91	50/200	18/10	029408



# Ice cream cup

Coupe à glace • Ijsbeker • Eisbecher • Coppetta da gelato • Copa helado • Pucharek do lodów • Вазочка для мороженого • Κούπα παγωτού

Ref	Int. length (a)	Ext. length (b)	Width (d)	Height (h)	Capacity (i)	Thickness (e)	gr	Master (Pcs)	Steel	EAN 5413521+
3010	100	104		52		0,8	76	20/160	18/10	030107
3010-E	100	104		52		0,8	84	20/160	14/1	100305

# Egg cup

Coquetier • Eierdopje • Eierbecher • Portauovo • Huevero • Kieliszek do jaj • Подставка для яйца • Αυγουλιέρα

Ref	Int. length (a)	Ext. length (b)	Width (d)	Height (h)	Capacity (i)	Thickness (e)	gr	Master (Pcs)	Steel	EAN 5413521+
2300	49	50		52		0,5	28	60/600	14/1	023000



# Sugar dispenser

Sucrier doseur • Suikerdoseerder • Zuckerstreuer • Dosatore zucchero • Azucarero dosificador • Dozownik do cukru • Дозатор для сахара • Δοσομετρητής ζάχαρης

Ref	Int. length (a)	Ext. length (b)	Width (d)	Height (h)	Capacity (i)	Thickness (e)	gr	Master (Pcs)	Steel	EAN 5413521+
3125		130	70	135	18		209	60	18 Cr	031258

# Bottle coaster

Sous-bouteille • Fles onderzetter • Flaschenuntersetzer • Sottobottiglia • Posa botella • Podstawka pod butelkę • Подставка для бутылки • Σουβέρ για μπουκάλια

Ref	Int. length (a)	Ext. length (b)	Width (d)	Height (h)	Capacity (i)	Thickness (e)	gr	Master (Pcs)	Steel	EAN 5413521+
1801	110	130		6		0,6	62	60/240	18/10	018013





## Table cloth clip (set of 4)

Attaches-nappe • Tafelkleed clip • Tischtuchhalter • Fermatovaglia • Tie mantel • Klips Do Obrusów • Зажим для скатерти • Κλιπ τραπεζομάντηλου

Ref	Int. length (a)	Ext. length (b)	Width (d)	Height (h)	Capacity (i)	Thickness (e)	gr	Master (Pcs)	Steel	EAN 5413521+
793							60	12/192	18 Cr	007932

## Seafood plate stand

Support plateau fruits de mer • Staander zeevruchtenschotel • Meeresfrüchte Plattenständer • SUPPorto per piatto di frutti di mare • Soporte bandeja de mariscos • Aca na owoce morz • Подставка для блюда с морепродуктами • Βάση πιάτου θαλασσινών



Ref	Int. length (a)	Ext. length (b)	Width (d)	Height (h)	Capacity (i)	Thickness (e)	gr	Master (Pcs)	Steel	EAN 5413521+
3400	195	285		200			300	64	chromed	034006



## Mussel dish

Plat à moules • Mosselschotel • Muschelteller • Piatto per mitil • Fuente para mejillones • Talerz na małże • Блюдо для мидий • Πιάτο μυδιών

Ref	Int. length (a)	Ext. length (b)	Width (d)	Height (h)	Capacity (i)	Thickness (e)	gr	Master (Pcs)	Steel	EAN 5413521+
425	220	250		10		1,0	440	10/50	18/10	004252

# Lobster cracker

Pince à homard • Kreeftenschaar • Hummerschere • Pinza per aragosta •  
Pinza bogavante • Szczypce do homarów • Щипцы для омаров •  
Σπαστρας αστακού

Ref	Int. length (a)	Ext. length (b)	Width (d)	Height (h)	Capacity (i)	Thickness (e)	gr	Master (Pcs)	Steel	EAN 5413521+
3015	157						102	50		030152



# Champagne bucket

Seau à champagne • Champagnekoeler • Sektkühler • Secchiello per champagne •  
Cubo de champán • Wiaderko na szampana • Ведёрко для шампанского • Σαμπανιέρα

Ref	Int. length (a)	Ext. length (b)	Width (d)	Height (h)	Capacity (i)	Thickness (e)	gr	Master (Pcs)	Steel	EAN 5413521+
2905	198			210	400	0,4	560	24	14/1	029057

# Champagne bucket

Seau à champagne • Champagnekoeler • Sektkühler • Secchiello per champagne •  
Cubo de champán • Wiaderko na szampana • Ведёрко для шампанского • Σαμπανιέρα

Ref	Int. length (a)	Ext. length (b)	Width (d)	Height (h)	Capacity (i)	Thickness (e)	gr	Master (Pcs)	Steel	EAN 5413521+
2904	190			190	325	1,0	540	5/30	18 Cr	029040





## Sugar bowl "bistrot"

Sucrier • Suikerpot • Zuckerdose • Zuccheriera • Azucarero • Cukiernica • Сахарница • Ζαχαριέρα

Ref	Int. length (a)	Ext. length (b)	Width (d)	Height (h)	Capacity (i)	Thickness (e)	gr	Master (Pcs)	Steel	EAN 5413521+
899	127			145		0,5	347	24	18/10	008991

## Ashtray

Cendrier • Asbak • Aschenbecher • Portacenere • Cenicero • Popielniczka • Пепельница • Τασάκι



Ref	Int. length (a)	Ext. length (b)	Width (d)	Height (h)	Capacity (i)	Thickness (e)	gr	Master (Pcs)	Steel	EAN 5413521+
608		80		29		1,5	111	12/120	18/10	006089



## Paring & bread knife

Couteau à éplucher / à pain • groenten & broodmes • gemüse & Brotmesser • Coltello da cucina & pane • recortes y cuchillo de pan • Νόζ do obierania/do chleba • Нож для очистки овощей; нож для хлеба • Μαχαίρι Ξεφλουδίσματος & Ψωμού

	Length (mm)	Gage (mm)	Master (Pcs)	Steel	EAN : 5413521+
5320	200	-	1	13 Cr	053205
5307	70	-	1	13 Cr	053076

## Spaghetti tong

Pince à spaghetti • Spaghettitang • Spaghetztange • Pinza per spaghetti • Pinza espaguetsis • Szczyrce do spaghetti • Щипцы для спагетти • Λαβίδα μακαρονιών

Ref	Int. length (a)	Ext. length (b)	Width (d)	Height (h)	Capacity (i)	Thickness (e)	gr	Master (Pcs)	Steel	EAN 5413521+
2926	210					0,8	84	144	18 cr.	029262



## Utility tong

Pince • Tang • Zange • Pinza • Pinza • Szczyrce • Щипцы универсальные • Λαβίδα

Ref	Int. length (a)	Ext. length (b)	Width (d)	Height (h)	Capacity (i)	Thickness (e)	gr	Master (Pcs)	Steel	EAN 5413521+
3117	230					0,5	50	144	18 Cr	031173
3117S	230					0,5	77	12/300	18 Cr	031173
3119	400					0,8	126	24/144	18 Cr	031197

## Basting spoon

Cuillère à ragout • Groentenlepel • Ragoutlöffel • Cucchiaio da ragout • Cuchara servir • Łyżka do gulaszu • Ложка для подливки • Κουτάλι περιχύσεως

Ref	Int. length (a)	Ext. length (b)	Width (d)	Height (h)	Capacity (i)	Thickness (e)	gr	Master (Pcs)	Steel	EAN 5413521+
785	315					2,0	120	12/144	18 Cr	007857
785P	315					2,0	119	12/144	18 Cr	078512





## Waffle fork

Fourchette à gaufre • Wafelvork • Waffelgabel • Forchetta per wafel • Banda de waffle • Widelec do gofrów • Вилка для вафель • Πιρούνι Wafel

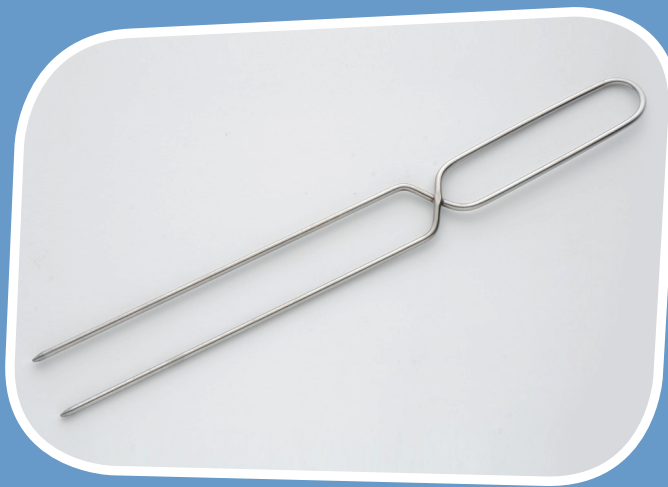

Ref	Int. length (a)	Ext. length (b)	Width (d)	Height (h)	Capacity (i)	Thickness (e)	gr	Master (Pcs)	Steel	EAN 5413521+
792		350				4,0	55	100	18/10	007925

## Cake tong

Pince à gâteau • Gebakjestang • Gebäckzange • Pinza per dolci • Pinza pastel • Szczypce do ciastek • Щипцы для торта • Λαβίδα γλυκού



Ref	Int. length (a)	Ext. length (b)	Width (d)	Height (h)	Capacity (i)	Thickness (e)	gr	Master (Pcs)	Steel	EAN 5413521+
3115		195				1,5	77	24/240	18 Cr	031159

Antifreeze  
ice cream scoop

Portionneur à glace • Ijschepper • Eisportionierer • Cucchiaio dosatore per gelato • Racionador • Dozownik do lodu • Ложка для мороженого • Κουτάλι σερβιρίσματος παγωτού

Ref	Int. length (a)	Ext. length (b)	Width (d)	Height (h)	Capacity (i)	Thickness (e)	gr	Master (Pcs)	Steel	EAN 5413521+
3001	175						136	12/144	Alu	030015

# Ice cream scoop

Portionneur à glace • Ijschepper • Eisportionierer • Cucchiaino dosatore per gelato • Racionador • Dozownik do lodu • Ложка для мороженого • Κουτάλι αερβιρίσματος παγωτού

Ref	Int. length (a)	Ext. length (b)	Width (d)	Height (h)	Capacity (i)	Thickness (e)	gr	Master (Pcs)	Steel	EAN 5413521+
3002-45	45				35	1,0	123	24/144	18/10	530027
3002-50	50				40	1,0	133	24/144	18/10	030022
3002-56	56				53	1,0	154	24/144	18/10	630024



# Zakouski spoon

	Length (mm)	Gage (mm)	Master (Pcs)	Steel	EAN : 5413521+
1900-34	118	1,8	300	18 Cr	900349
1420-34	117	2,0	300	18/10	420342
973-34	124	2,0	300	18/10	973343

# Zakouski fork

	Length (mm)	Gage (mm)	Master (Pcs)	Steel	EAN : 5413521+
958-39	117	1,8	12/600	18 Cr	958395



# Steak knife

Couteau steak • Steakmes • Steakmesser • Coltello Da Bistecca • Cuchillo de carne •  
Νόζ do steków • Нож для стейка (ручка из ABS) • Μαχαίρι Μπιριζόλας



	Length (mm)	Gage (mm)	Master (Pcs)	Steel	EAN : 5413521+
761	223	-	12/240	13 Cr	007611
763	215	-	12/72/504	13 Cr	007635

# Tapas

	Length (mm)	Gage (mm)	Master (Pcs)	Steel	EAN : 5413521+
2111731	200	2,0	12/300	18 Cr	117310
391059	99	2,0	12/300	18 Cr	910591
207059	102	1,0	12/300	18 Cr	070592



# Tapas

	Length (mm)	Gage (mm)	Master (Pcs)	Steel	EAN : 5413521+
291161	121	1,5	12/300	18 Cr	911611
104192	98	1,2	12/300	18 Cr	041929

# Tapas

	Length (mm)	Gage (mm)	Master (Pcs)	Steel	EAN : 5413521+
207760	125	1,2	12/300	18 Cr	077607
291162	124	1,5	12/300	18 Cr	911628
207765	111	1,2	12/300	18 Cr	077652



## Periwinkle skewers (set of 12)

Piques à bigorneaux • Kreukelprikkers • Strandschnecken spiesser • Spiedini • Recoge bigaros • widelec do ślimaków • Шампурчики для моллюсков (набор из 12 шт) • Διαλέγει θάλασσα σαλιγκάρια

	Length (mm)	Gage (mm)	Master (Pcs)	Steel	EAN : 5413521+
3017	71	-	167	18 Cr	030176



## Lobster fork (set of 12)

Curette à homard • kreeftvork • hummergabel • forchetta per aragosta • Tenedor bogavante • Widelec do homarów • Вилочка для омара • Πιρούλι αστακού

	Length (mm)	Gage (mm)	Master (Pcs)	Steel	EAN : 5413521+
783	187	2,0	50	18 Cr	007833





## Grapefruit spoon

Cuillère à agrumes • Citrusvruchtenlepel • Zitrusfrüchtelöffel • Cucchiaio per pompelmo •  
Cuch. para cítricos • Łyżeczka do cytrusów • Ложка для грейпфрута • Κουτάλι  
γκρέιφρουτ

	Length (mm)	Gage (mm)	Master (Pcs)	Steel	EAN : 5413521+
784	145	2,0	12/600	18 Cr	007840

## Absinth spoon

Cuillère à absinthe • Absintlepel • Absinthlöffel • Cucchiaio per assenzio • Pala a absenta •  
Łopatkka do absyntu • Ложка для абсента • Κουτάλι αψεντιού

	Length (mm)	Gage (mm)	Master (Pcs)	Steel	EAN : 5413521+
771	167	1,0	12/600	18/10	007710



## Eternum Liquid

Cleaning fluid stainless steel

Nettoyant liquide acier inox • Vloeibare Reiniger Roestvrijstaal •  
Flüssiges Reinigungsmittel rostfreier stahl • Limpiador liquido  
acero inoxidable • Mleczko do czyszczenia stali nierdzewnej

	Capacity (l)	Master (Pcs)	gr	EAN : 5413521+
9999	250	12	340	099999

# Qui sommes-nous ?



Eternum,  
votre spécialiste  
en couverts  
depuis 1924

Eternum a été fondée en 1924.

Notre siège principal est établi à Gembloux (Belgique), où se situent également notre unité de production belge ainsi qu'un entrepôt de 3 000 palettes.

Nous sommes une filiale à 100% du groupe norvégien K.A.Rasmussen ([www.ka-rasmussen.no](http://www.ka-rasmussen.no)), un holding spécialisé dans la production et la vente de métaux précieux destinés au marché des biens de consommation et l'industrie.

Eternum se concentre exclusivement sur les couverts et accessoires en inox pour la table et les buffets. Cette approche spécialisée, combinée à une stratégie de design intensive, nous a permis de devenir un des fournisseurs de couverts les plus en vue sur la scène internationale.

Nous sommes présents dans 60 pays à travers notre réseau de distributeurs et d'agents locaux, et tous nos articles sont livrables de stock.

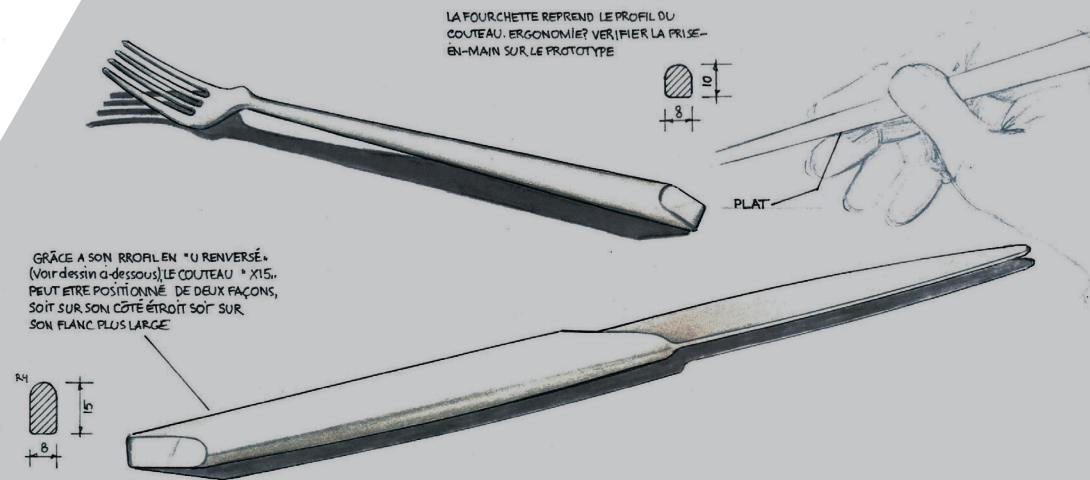

*Cher client,*

*Chez Eternum, le service clientèle est le plus important des produits. Votre satisfaction est au cœur de notre vision et de notre mission.*

*Ce service ne se limite pas à un taux de fiabilité des livraisons supérieur à 98 %, mais prend cette dimension supplémentaire dont, aujourd'hui plus que jamais, vous avez besoin :*

- des réponses rapides et flexibles à vos questions et à vos besoins ;*
- le choix de nouveaux designs qui doperont à la fois votre chiffre d'affaire et la satisfaction de vos clients ;*
- une gestion rigoureuse de nos frais généraux afin de pouvoir vous offrir la qualité au juste prix.*

*Cette vision, nous nous efforçons de la mettre en pratique au quotidien, à chaque niveau de l'entreprise, de façon à ce que vous puissiez à tout moment compter sur l'enthousiasme et le dévouement de toute l'équipe d'Eternum.*

*À votre service,*

*Frank De Lombaert  
Administrateur délégué*

*Tore Aasbakken  
Président du Conseil  
d'administration*

# Designers

Petit pays situé en plein cœur de l'Europe, la Belgique est un melting-pot d'influences, de langues et de cultures diverses.

En tant qu'entreprise belge, nous avons donc choisi de collaborer principalement avec des designers belges, dont certains se sont déjà forgé une réputation internationale.



Designer of  
BELGIUM  
the year 2007



Nedda El Asmar  
**DESIGNER**  
[www.nedda.be](http://www.nedda.be)  
**WEB SITE**



Louis de Limburg  
**DESIGNER**  
[www.stirum-design.be](http://www.stirum-design.be)  
**WEB SITE**

Designer of  
BELGIUM  
the year 2008



Stefan Schöning  
**DESIGNER**  
[www.stefanschoning.com](http://www.stefanschoning.com)  
**WEB SITE**



Adrien Ciejak &  
Pierre Duthoit  
**DESIGNER**  
[www.plllus.com](http://www.plllus.com)  
[www.adrienciejak.com](http://www.adrienciejak.com)  
**WEB SITE**



Pierre Collard  
**DESIGNER**  
[www.pierrecollard.com](http://www.pierrecollard.com)  
**WEB SITE**



Louise Charlier  
**DESIGNER**  
[www.louisecharlier.be](http://www.louisecharlier.be)  
**WEB SITE**



Santiago Sevillano  
**DESIGNER**  
[www.santiagosevillano.com](http://www.santiagosevillano.com)  
**WEB SITE**

# Découvrez nos 3 collections

eternum 

La gamme Eternum est idéale pour des ambiances plus décontractées.

- > Utilisation d'acier 18/10 et 18/0.
- > Les nouveaux modèles sont créés soit par des designers externes, soit par notre département design interne.

eternum   
*signature*





# gastronum

## LE DESIGN À PORTÉE DE MAIN

Eternum Signature est une collection de qualité supérieure destinée aux meilleurs hôtels et restaurants.

- > Utilisation exclusive d'acier 18/10.
- > Les nouveaux modèles sont systématiquement créés en collaboration avec des designers externes.

La gamme Gastronum regroupe une collection d'accessoires de table destinée :

- > à la gastronomie luxueuse,
- > aux activités de catering.



Nous personnalisons vos commandes pour vous fournir les couverts parfaitement adaptés à vos besoins.

Poinçonnage  
AVEC OU SANS REPOLISSAGE



Électrolyse



Gravure au laser



Gravure au diamant



Repolissage mat



Sablage



Argenture

**COUVERTS 33 OU 40 MICRONS  
VAISSELLE 10 OU 15 MICRONS**



Dorure



Revêtement PVD

**ANTHRACITE**



Revêtement PVD

**OR**



**USAGE ALIMENTAIRE - ANTI-RAYURES - MIN. 400 PCS/COULEUR**

**USAGE ALIMENTAIRE - ANTI-RAYURES - MIN. 400 PCS/COULEUR**

# Wie zijn we?



Eternum  
Uw bestekspecialist  
sinds 1924

Eternum werd opgericht in 1924.

Ons hoofdkwartier is gevestigd in Gembloux, België, waar zich ook onze Belgische productie-unit en een warehouse voor 3000 palletten bevindt.

Wij zijn een 100% dochterbedrijf van de Noorse K.A.Rasmussen groep ([www.ka-rasmussen.no](http://www.ka-rasmussen.no)), een holding gespecialiseerd in de productie en verkoop van edele metalen voor consumenten- en industriële markten.

Eternum focust zich uitsluitend op roestvrijstalen bestek en accessoires voor de gedekte tafel en buffetten. Dankzij deze gespecialiseerde niche-aanpak en ons intensief productontwikkelingsbeleid zijn wij uitgegroeid tot een belangrijke bestekleverancier op internationaal niveau.

Wij beschikken over een netwerk van distributeurs en lokale agenten in 60 landen en ons volledig assortiment is leverbaar uit voorraad.

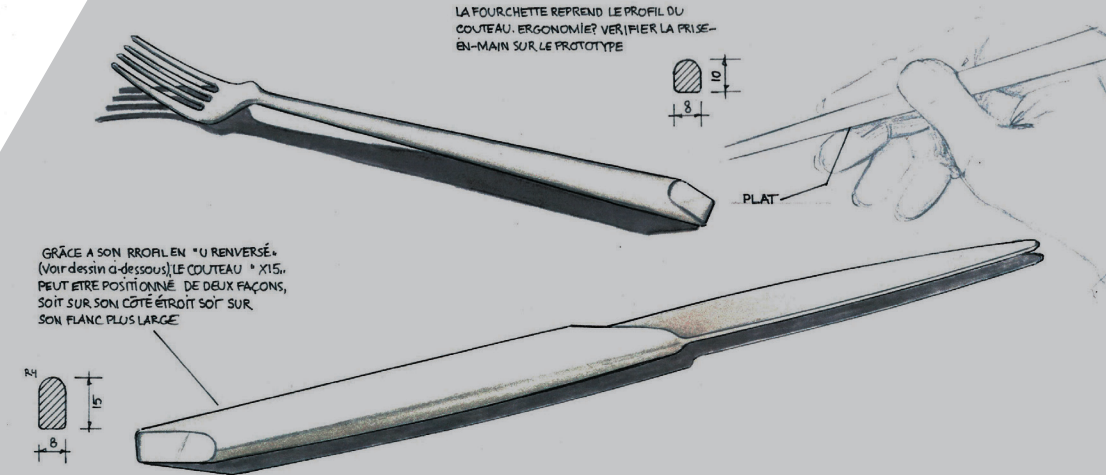

Beste Klant,

Eternum's visie en missie begint bij U als klant en ons belangrijkste product is klantenservice.

Service niet enkel in de vorm van 98% leverbetrouwbaarheid, maar versterkt met die extra dimensie die U als klant vandaag meer dan ooit nodig hebt:

- snel en flexibel op Uw vragen en behoeften kunnen inspelen,
- de juiste nieuwe producten ontwikkelen zodat U Uw omzet en de tevredenheid van Uw klanten ziet toenemen,
- strenge beheersing van onze overheadkosten om U kwaliteit te kunnen aanbieden tegen een correcte prijs.

Dagelijks werken wij aan het in de praktijk brengen van deze visie in alle lagen van de onderneming, zodat U permanent kan rekenen op de inzet van het ganse Eternum team!

Steeds tot Uw dienst,

Frank De Lombaert      Tore Aasbakken  
Gedelegeerd bestuurder      Voorzitter Raad van Bestuur

# Designers

België, als klein land in het centrum van Europa, is een smeltkroes van diverse invloeden, talen en culturen.

Daarom werken wij als Belgische firma voornamelijk met Belgische ontwerpers, waarvan sommigen een sterke reputatie hebben opgebouwd op internationaal vlak.



Designer of  
BELGIUM  
the year 2007



Nedda El Asmar  
**DESIGNER**  
[www.nedda.be](http://www.nedda.be)  
**WEB SITE**



Louis de Limburg  
**DESIGNER**  
[www.stirum-design.be](http://www.stirum-design.be)  
**WEB SITE**

Designer of  
BELGIUM  
the year 2008



Stefan Schöning  
**DESIGNER**  
[www.stefanschoning.com](http://www.stefanschoning.com)  
**WEB SITE**



Adrien Ciejak &  
Pierre Duthoit  
**DESIGNER**  
[www.plllus.com](http://www.plllus.com)  
[www.adrienciejak.com](http://www.adrienciejak.com)  
**WEB SITE**



Pierre Collard  
**DESIGNER**  
[www.pierrecollard.com](http://www.pierrecollard.com)  
**WEB SITE**



Louise Charlier  
**DESIGNER**  
[www.louisecharlier.be](http://www.louisecharlier.be)  
**WEB SITE**



Santiago Sevillano  
**DESIGNER**  
[www.santiagosevillano.com](http://www.santiagosevillano.com)  
**WEB SITE**

# Ontdek onze 3 collecties

eternum 

Het Eternum assortiment past perfect in een casual dining omgeving.

- > Zowel 18/10 als 18/0 staal worden gebruikt.
- > Nieuwe modellen worden ofwel ontworpen door externe designers ofwel door onze interne designafdeling.

eternum   
*signature*



# gastronum

## DESIGN BINNEN HANDBEREIK

Eternum Signature is een hoogwaardige collectie voor de betere hotels en restaurants.

- > Enkel 18/10 staal wordt gebruikt.
- > Ontwikkeling van nieuwe modellen gebeurt steeds in samenwerking met externe designers.

Het Gastronum-gamma bevat een verzameling tafelaccessoires bestemd voor:

- > de luxueuze gastronomie,
- > cateringactiviteiten.



We kunnen uw bestellingen personaliseren om perfect aan uw behoeften te voldoen.

Stempelen  
MET OF ZONDER OVERPOLIJSTING



Etsen (Elektrolyse)



Graveren laser



Graveren diamant





Matte overpolijsting



Zandstralen



Verzilveren

**BESTEK 33 OF 40 MICRON  
TAFELARTIKELN 10 OF 15 MICRON**



Vergulden



PVD coating

**ANTRACIET**



PVD coating

**GOUD**



# Wer sind wir?



Eternum  
Ihr Fachmann  
für Besteck  
seit 1924

Eternum wurde 1924  
gegründet.

Unsere Zentrale befindet sich  
in Gembloux in Belgien, wo auch  
unsere belgische Produktionsan-  
lage und das Lager für 3.000 Pal-  
etten gelegen ist.

Wir sind eine 100%ige Tochtergesells-  
chaft des norwegischen K.A.Rasmussen-  
Konzerns ([www.ka-rasmussen.no](http://www.ka-rasmussen.no)), einer  
Holding, die auf die Produktion und den  
Verkauf von Edelmetallen für Verbraucher- und  
industrielle Märkte spezialisiert ist.

Eternum konzentriert sich ausschließlich auf  
Besteck und Accessoires für den gedeckten Tisch  
und Büffets aus rostfreiem Stahl. Dank dieses spezial-  
isierten Nischenansatzes und unserer intensiven Produk-  
tentwicklungspolitik haben wir uns zu einem bedeutenden  
Bestecklieferant auf internationalem Niveau entwickelt.

Wir verfügen über ein Netzwerk von Vertriebspartnern und  
lokalen Vertretern in 60 Ländern, und unser vollständiges Sorti-  
ment ist ab Lager lieferbar.

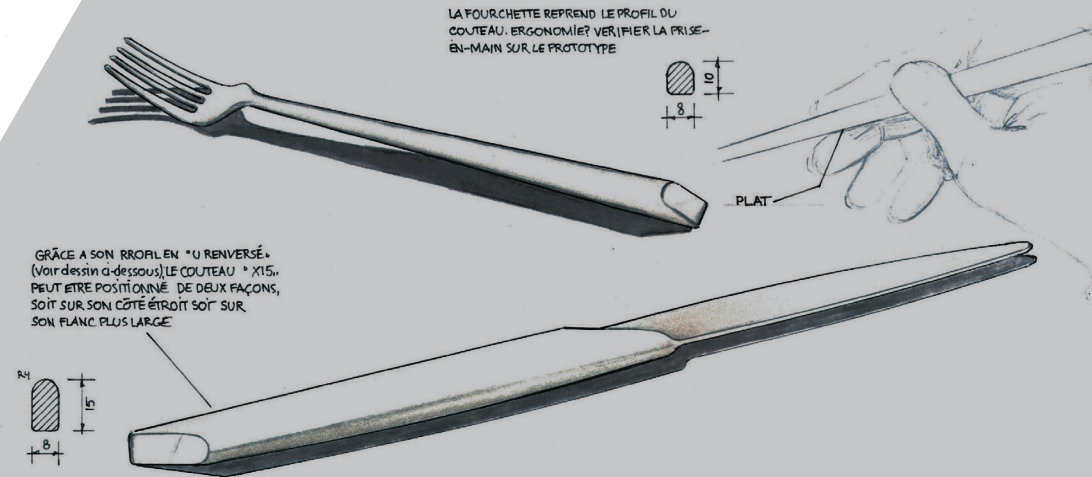

**Sehr geehrter Kunde,**

**Die Vision und Mission von Eternum beginnt bei Ihnen als Kunden, und unser wichtigstes Produkt ist Kundenservice.**

**Service nicht nur in Form von 98% Liefertreue, sondern verstärkt mit der extra Dimension, die Sie als Kunde heute mehr als je zuvor benötigen:**

- **schnell und flexibel auf Ihre Fragen und Bedürfnisse eingehen zu können,**
- **die richtigen neuen Produkte zu entwickeln, sodass Ihr Umsatz und die Zufriedenheit Ihrer Kunden steigt,**
- **strenge Kontrolle unserer Gemeinkosten, um Ihnen Qualität zu einem korrekten Preis bieten zu können.**

**Täglich arbeiten wir an der Umsetzung dieser Vision auf allen Ebenen des Unternehmens, sodass Sie sich permanent auf den Einsatz des gesamten Eternum-Teams verlassen können!**

**Stets zu Ihren Diensten.**

**Frank De Lombaert**  
Geschäftsführender Vorstand

**Tore Aasbakken**  
Vorstandsvorsitzender

# Designers

Belgien - als kleines Land im Zentrum Europas - ist ein Schmelztiegel verschiedener Einflüsse, Sprachen und Kulturen.

Deshalb arbeiten wir als belgisches Unternehmen hauptsächlich mit belgischen Designern, von denen einige eine starke internationale Reputation aufgebaut haben.



Designer of  
BELGIUM  
the year 2007



Nedda El Asmar  
**DESIGNER**

[www.nedda.be](http://www.nedda.be)  
**WEB SITE**



Louis de Limburg  
**DESIGNER**

[www.stirum-design.be](http://www.stirum-design.be)  
**WEB SITE**

Designer of  
BELGIUM  
the year 2008



Stefan Schöning  
**DESIGNER**

[www.stefanschoning.com](http://www.stefanschoning.com)  
**WEB SITE**



Adrien Ciejak &  
Pierre Duthoit  
**DESIGNER**

[www.plllus.com](http://www.plllus.com)  
[www.adrienciejak.com](http://www.adrienciejak.com)  
**WEB SITE**



Pierre Collard  
**DESIGNER**

[www.pierrecollard.com](http://www.pierrecollard.com)  
**WEB SITE**



Louise Charlier  
**DESIGNER**

[www.louisecharlier.be](http://www.louisecharlier.be)  
**WEB SITE**



Santiago Sevillano  
**DESIGNER**

[www.santiagosevillano.com](http://www.santiagosevillano.com)  
**WEB SITE**

# Entdecken Sie unsere 3 Kollektionen

## eternum

Das Eternum-Sortiment passt perfekt in eine ungezwungene gastronomische Umgebung.

- > Sowohl 18/10- als auch 18/0-Stahl werden verwendet.
- > Neue Modelle werden entweder von externen Designern oder von unserer internen Designabteilung entworfen.

## eternum signature



## DESIGN IN REICHWEITE

Eternum Signature ist eine hochwertige Kollektion für die besseren Hotels und Restaurants.

- > Es wird ausschließlich 18/10-Stahl verwendet.
- > Die Entwicklung neuer Modelle erfolgt stets in Kooperation mit externen Designern.

Das Sortiment Gastronum umfasst eine Kollektion von Accessoires für den gedeckten Tisch:

- > für die Luxus-Gastronomie,
- > für Aktivitäten im Catering.



Wir können Ihre  
Bestellungen  
personalisieren,  
damit sie völlig  
Ihren Bedürfnissen  
entsprechen.

Prägung

MIT ODER OHNE ERNEUTEM POLIEREN



Ätzung (Elektrolyse)



Lasergravur



Diamantgravur



Erneutes polieren matt



Sandstrahlen



Versilberung

**BESTECK 33 ODER 40 MIKRON  
TISCHACCESSOIRES 10 ODER 15 MIKRON**



Vergoldung



PVD-Beschichtung

**ANTHRAZIT**



PVD-Beschichtung

**GOLD**



**LEBENSMITTELSICHER - KRATZFEST - MIND. 400 STÜCK/FARBE** **LEBENSMITTELSICHER - KRATZFEST - MIND. 400 STÜCK/FARBE**

# ¿Quiénes somos?

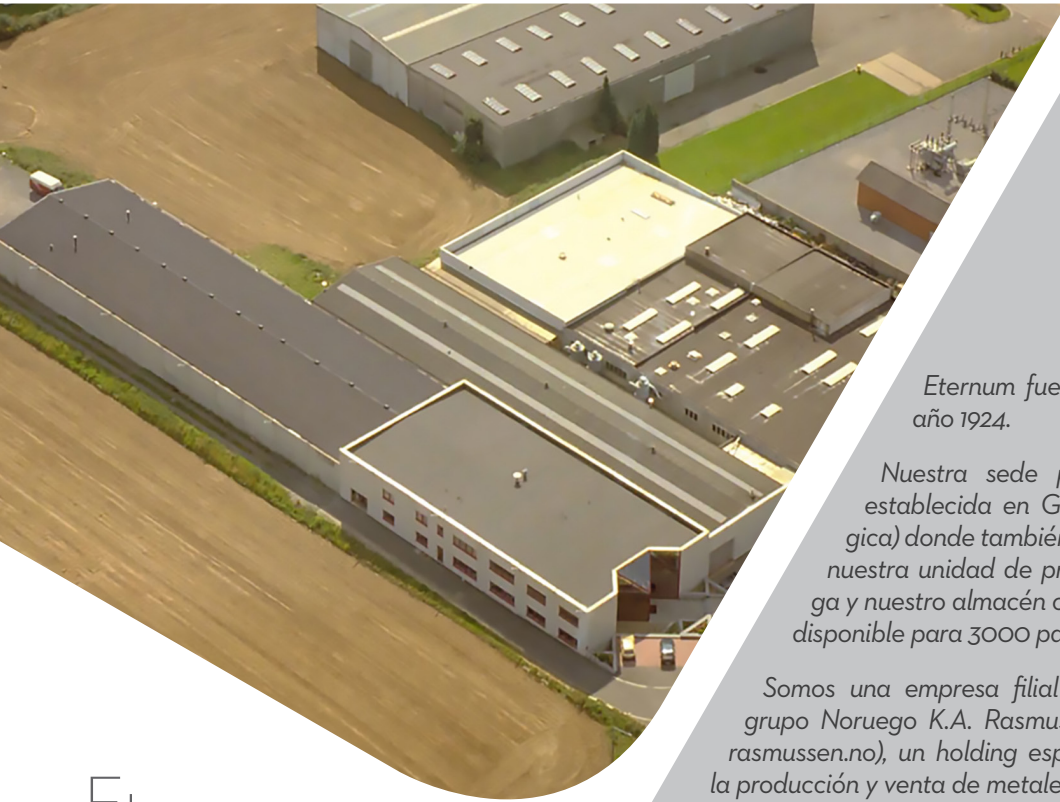

Eternum  
Su especialista  
en cubiertos  
desde 1924

112

Eternum fue creada en el año 1924.

Nuestra sede principal está establecida en Gembloux (Bélgica) donde también se encuentra nuestra unidad de producción Belga y nuestro almacén con un espacio disponible para 3000 palets.

Somos una empresa filial al 100% del grupo Noruego K.A. Rasmussen ([www.karasmussen.no](http://www.karasmussen.no)), un holding especializado en la producción y venta de metales nobles tanto para el consumidor directo como para los mercados industriales.

Eternum está centrado exclusivamente en la fabricación de cubiertos y accesorios en aceros inoxidables para la mesa y buffets. Esta especialización combinada con una estrategia de una gran variedad de diseños, nos ha permitido convertirnos en un proveedor a escala internacional.

Estamos presentes en 60 países a través de nuestra red de distribuidores y agentes locales y todos nuestros artículos están disponibles en nuestros almacenes.

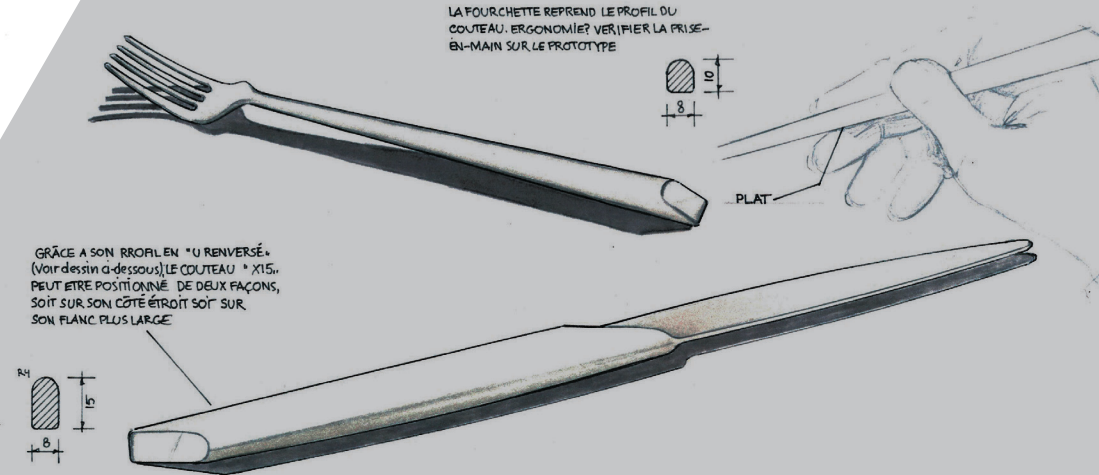

Estimado/a cliente/a:

La visión y la misión de Eternum comienza con usted como cliente y nuestro producto más importante es el servicio al cliente.

Servicio, no sólo en términos numéricos, con un 98% de fiabilidad a la hora de realizar las entregas, sino un servicio reforzado con los detalles que usted como cliente necesita hoy más que nunca:

- rapidez y flexibilidad para responder a sus preguntas y necesidades;
- desarrollo de los productos nuevos adecuados para que usted vea aumentar tanto sus beneficios como la satisfacción de sus clientes;
- alto dominio de nuestros gastos indirectos para poder ofrecerle calidad a un precio correcto.

Nuestro trabajo diario se centra en llevar a la práctica esta visión en todos los niveles de la sociedad para que usted pueda contar con la dedicación de todo el equipo Eternum.

Siempre a su servicio,

Frank De Lombaert  
Administrador Delegado

Tore Aasbakken  
Presidente del Consejo  
de Administración



# Designers

Como país pequeño en el centro de Europa, Bélgica es un crisol de influencias, idiomas y culturas.

Por eso, como empresa belga, trabajamos principalmente con diseñadores belgas, de los cuales algunos de ellos han alcanzado una gran reputación a escala internacional.



Designer of  
BELGIUM  
the year 2007



Nedda El Asmar  
**DESIGNER**  
[www.nedda.be](http://www.nedda.be)  
**WEB SITE**



Louis de Limburg  
**DESIGNER**  
[www.stirum-design.be](http://www.stirum-design.be)  
**WEB SITE**

Designer of  
BELGIUM  
the year 2008



Stefan Schöning  
**DESIGNER**  
[www.stefanschoning.com](http://www.stefanschoning.com)  
**WEB SITE**



Adrien Ciejak &  
Pierre Duthoit  
**DESIGNER**  
[www.plllus.com](http://www.plllus.com)  
[www.adrienciejak.com](http://www.adrienciejak.com)  
**WEB SITE**



Pierre Collard  
**DESIGNER**  
[www.pierrecollard.com](http://www.pierrecollard.com)  
**WEB SITE**



Louise Charlier  
**DESIGNER**  
[www.louisecharlier.be](http://www.louisecharlier.be)  
**WEB SITE**



Santiago Sevillano  
**DESIGNER**  
[www.santiagosevillano.com](http://www.santiagosevillano.com)  
**WEB SITE**

# Descubre nuestras 3 colecciones

## eternum

La gama Eternum encaja perfectamente en un entorno de cena informal.

- > Se utiliza tanto acero 18/10 como 18/0.
- > El diseño de los modelos nuevos se lleva a cabo de la mano de diseñadores externos o de nuestro departamento interno de diseño.

## eternum *signature*



# gastronum

## DISEÑO AL ALCANCE DE LA MANO

Eternum Signature es una colección de alta calidad para hoteles y restaurantes de nivel más alto.

- > Sólo se utiliza acero 18/10.
- > El diseño de los modelos nuevos siempre se lleva a cabo de la mano de diseñadores externos.

La gama Gastronum se compone de una colección de artículos de mesa destinada:

- > a la alta cocina,
- > al catering.



Podemos personalizar  
sus pedidos para  
satisfacer plenamente sus  
necesidades

Grabado en relieve  
**CON O SIN REPULIDO**



Grabado al ácido (Electrolisis)



Grabado con láser



Grabado con diamante



Repulido mate



Chorro de arena



Plateado

**CUBERTERÍA DE 33 Ó 40 MICRÓMETROS ARTÍCULOS DE MESA DE 10 Ó 15 MICRÓMETROS**



Chapado en oro



Capa de PVD

**ANTRACITA**



Capa de PVD

**ORO**



# Kim jesteśmy?



Eternum  
Państwa specjalista  
w kreowaniu  
sztućców  
od 1924 r.

118

Dysponujemy siecią dystrybutorów oraz lokalnych agentów w 60 krajach, a nasz cały asortyment dostarczamy ze stałych zapasów magazynowych.

Firma Eternum została założona w 1924 r.

Nasza siedziba główna mieści się w belgijskiej miejscowości Gembloux, gdzie znajduje się również nasz belgijski oddział produkcyjny oraz magazyn na 3000 palet.

W 100% stanowimy spółkę-córkę norweskiej grupy K.A.Rasmussen ([www.karasmussen.no](http://www.karasmussen.no)), holdingu specjalizującego się w produkcji i sprzedaży metali szlachetnych dla rynku konsumenckiego i przemysłowego.

Eternum koncentruje się wyłącznie na wyrobie sztućców i akcesoriów ze stali nierdzewnej do nakrycia stołu oraz bufetów. Dzięki takiemu niszowemu podejściu i naszej polityce intensywnego rozwijania produktów staliśmy się ważnym dostawcą sztućców na międzynarodowym poziomie.

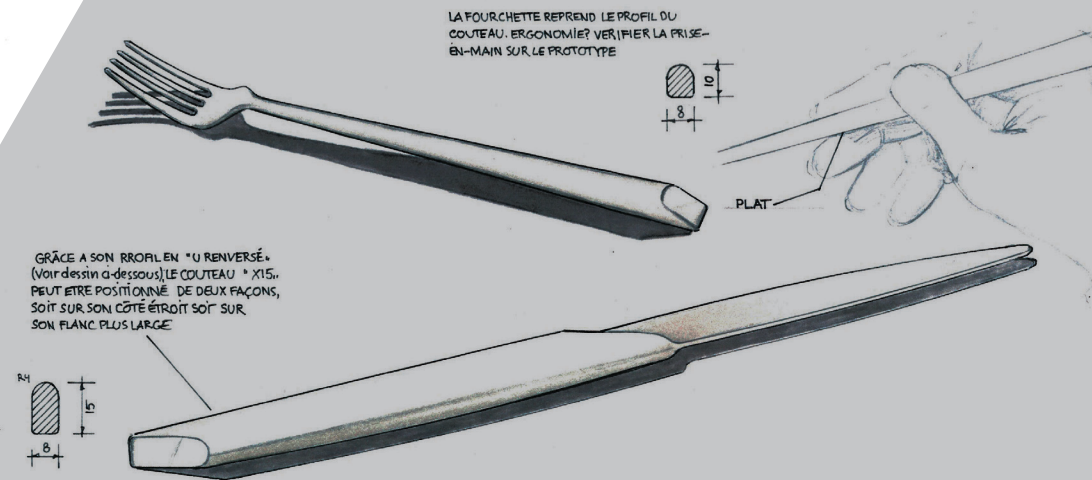

Szanowni Klienci,

Wizja i misja Eternum zaczyna się od Państwa, jako naszych klientów, a naszym najważniejszym produktem jest obsługa klienta.

Obsługa ta wyraża się nie tylko w niezawodności w dostawach na poziomie 98%. Wzmacniają ją dodatkowe wartości, których Państwo, jako klienci, potrzebują dziś szczególnie. Są to:

- szybka i elastyczna reakcja na Państwa pytania i potrzeby;
- projektowanie odpowiednich nowych produktów tak, aby zwiększyć Państwa zyski i zadowolenie Państwa klientów;
- solidne zarządzanie naszymi kosztami ogólnymi, by móc zaoferować Państwu jakość za rozsądną cenę.

Każdego dnia staramy się urzeczywistnić naszą wizję na każdym poziomie przedsiębiorstwa tak, aby zawsze mogli Państwo liczyć na zaangażowanie całego zespołu Eternum!

Zawsze do Państwa dyspozycji,

Frank De Lombaert  
Delegowany członek  
zarządu

Tore Aasbakken  
Prezes zarządu

# Designers

Będąc niewielkim krajem w sercu Europy, Belgia stanowi tygiel różnych wpływów, języków i kultur.

Dlatego jako belgijska firma pracujemy w głównej mierze z belgijskimi projektantami, wśród których są osoby cieszące się doskonałą reputacją na szczeblu międzynarodowym.



Designer of  
BELGIUM  
the year 2007



Nedda El Asmar  
**DESIGNER**

[www.nedda.be](http://www.nedda.be)  
**WEB SITE**



Louis de Limburg  
**DESIGNER**

[www.stirum-design.be](http://www.stirum-design.be)  
**WEB SITE**

Designer of  
BELGIUM  
the year 2008



Stefan Schöning  
**DESIGNER**

[www.stefanschoning.com](http://www.stefanschoning.com)  
**WEB SITE**



Adrien Ciejak &  
Pierre Duthoit  
**DESIGNER**

[www.plllus.com](http://www.plllus.com)  
[www.adrienciejak.com](http://www.adrienciejak.com)  
**WEB SITE**



Pierre Collard  
**DESIGNER**

[www.pierrecollard.com](http://www.pierrecollard.com)  
**WEB SITE**



Louise Charlier  
**DESIGNER**

[www.louisecharlier.be](http://www.louisecharlier.be)  
**WEB SITE**



Santiago Sevillano  
**DESIGNER**

[www.santiagosevillano.com](http://www.santiagosevillano.com)  
**WEB SITE**

# Odkryj nasze trzy kolekcje

eternum 

Linie Eternum doskonale sprawdzą się w restauracji typu "casual dining".

- > Do produkcji używa się stali zarówno 18/10 jak i 18/0.
- > Nowe modele są projektowane zarówno przez projektantów zewnętrznych jak również przez nasz Dział Projektowania.

eternum   
*signature*





## DESIGN NA WYCIĄgniĘCIE DŁONI

Eternum Signature to wysokiej jakości kolekcja dla hoteli i restauracji, o wysokich standardach.

- > Wykorzystywana jest wyłącznie stal 18/10.
- > Projektowanie nowych modeli odbywa się w ciągłej współpracy z projektantami z zewnątrz.



Możemy dostosować  
zamówienia do Państwa  
potrzeb

Wytłaczanie

**Z PONOWNYM POLEROWANIEM LUB BEZ POLEROWANIA**



Wytrawianie (Elektroliza)



Grawerowanie laserowe



Grawerowanie diamentem



Ponowne polerowanie matowe



Piaskowanie



Platerowanie srebrem

**SZTUĆCE 33 LUB 40 MIKRONY ZASTAWA STOŁOWA  
10 LUB 15 MIKRONÓW**



Platerowanie złotem



Powłoka PVD

**ANTRACYT**



Powłoka PVD

**ZŁOTO**



**DOPUSZCZONE DO KONTAKTU Z ŻYWNOŚCIĄ - ODPORNE NA ZARYSOWANIA -  
MIN. 400 SZTUK/KOLOR**

**DOPUSZCZONE DO KONTAKTU Z ŻYWNOŚCIĄ - ODPORNE NA ZARYSOWANIA -  
MIN. 400 SZTUK/KOLOR**

# О нас?



Eternum  
Ваш эксперт в  
области столо-  
вой посу-  
ды с 1924 года.

Наша штаб-квартира находится в бельгийском городе Гемблoux, где также расположен производственный цех и склад на 3000 паллет.

Мы являемся 100% дочерним предприятием норвежской группы компаний K.A.Rasmussen ([www.ka-rasmussen.no](http://www.ka-rasmussen.no)), холдинга, специализирующегося на производстве и реализации высокосортных металлов для потребительского и промышленного рынков.

Eternum специализируется исключительно на столовой посуде и аксессуарах из нержавеющей стали для ресторанов и кафе. Благодаря такой узкой направленности и ориентировании на интенсивную разработку новой продукции мы стали крупным поставщиком столовых приборов международного уровня.

Мы располагаем дистрибьюторской и агентской сетью, которая охватывает 60 стран, а вся продукция поставляется непосредственно со склада.

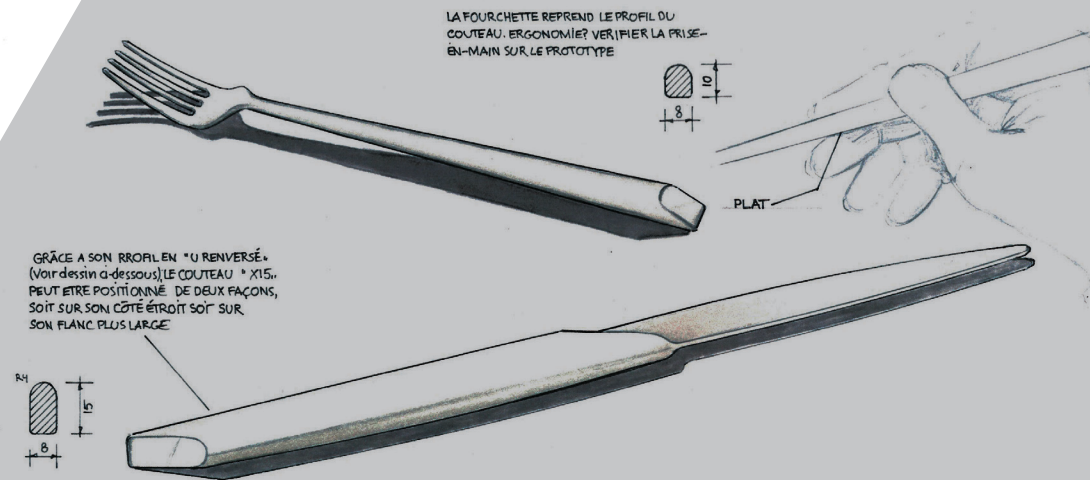

Уважаемый Клиент!

Миссия компании Eternum начинается с Вас, нашего клиента, а важнейшим элементом нашей деятельности является обслуживание клиентов.

Такое обслуживание не только подразумевает надежность поставок на уровне 98%, но и те дополнительные преимущества, которые сегодня как никогда нужны нашим клиентам:

- быстрое и гибкое решение Ваших вопросов и проблем,
- разработка именно такой продукции, благодаря которой Вы сможете увеличить свой оборот и в еще большей степени удовлетворить своих клиентов,
- строгий контроль наших накладных расходов, что дает нам возможность предложить Вам высокое качество по доступной цене.

Мы повседневно работаем над воплощением этих принципов на всех уровнях предприятия для того, чтобы Вы во всем и полностью могли положиться на профессиональный коллектив компании Eternum!

Всегда к Вашим услугам,

Франк Де Ломбарт  
Полномочный директор

Tore Aasbakken  
Председатель  
Правления

# Designers

Бельгия - небольшая страна в сердце Европы - является своеобразным котлом, в котором смешиваются различные течения, языки и культуры.

Поэтому, будучи бельгийской фирмой, мы работаем преимущественно с бельгийскими дизайнерами, некоторые из которых имеют отличную репутацию и на международной арене.



Designer of  
BELGIUM  
the year 2007



Nedda El Asmar  
**DESIGNER**  
[www.nedda.be](http://www.nedda.be)  
**WEB SITE**



Louis de Limburg  
**DESIGNER**  
[www.stirum-design.be](http://www.stirum-design.be)  
**WEB SITE**

Designer of  
BELGIUM  
the year 2008



Stefan Schöning  
**DESIGNER**  
[www.stefanschoning.com](http://www.stefanschoning.com)  
**WEB SITE**



Adrien Ciejak &  
Pierre Duthoit  
**DESIGNER**  
[www.plllus.com](http://www.plllus.com)  
[www.adrienciejak.com](http://www.adrienciejak.com)  
**WEB SITE**



Pierre Collard  
**DESIGNER**  
[www.pierrecollard.com](http://www.pierrecollard.com)  
**WEB SITE**



Louise Charlier  
**DESIGNER**  
[www.louisecharlier.be](http://www.louisecharlier.be)  
**WEB SITE**



Santiago Sevillano  
**DESIGNER**  
[www.santiagosevillano.com](http://www.santiagosevillano.com)  
**WEB SITE**

# Discover our 3 collections

eternum 

Коллекция Eternum отлично подойдет для неофициальной обстановки.

> Используется сталь 18/10 и 18/0.

> Новые модели разрабатываются либо с привлечением дизайнеров извне, либо нашим собственным дизайнерским отделом.

eternum   
*signature*



# gastronum

Роскошный дизайн всегда под рукой  
Eternum Signature – роскошная коллекция для дорогих  
отелей и ресторанов.

- > Используется только сталь 18/10.
- > Разработка новых моделей обязательно происходит с привлечением дизайнеров извне.

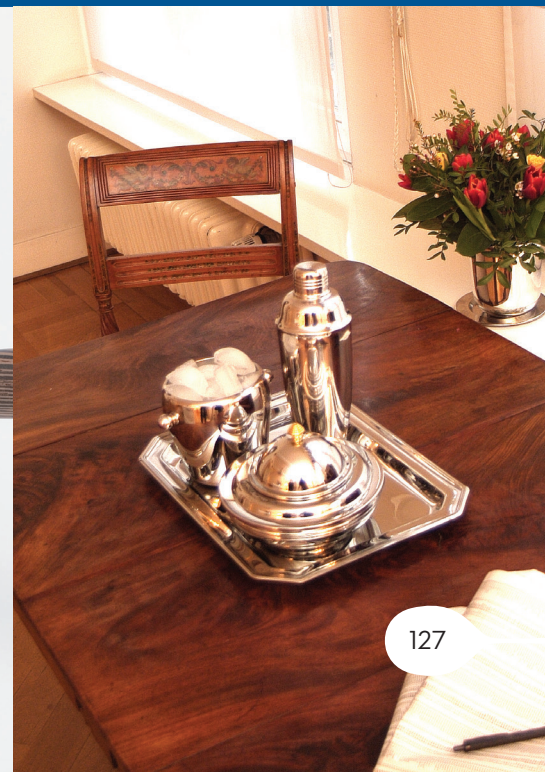

Мы поставим Вам  
именно такие товары,  
которые наиболее  
полно отвечают Вашим  
требованиям

### Тиснение

*С или без повторной полировки*



### Гравировка травлением (Электролиз)



### Лазерная гравировка



### Алмазная гравировка





## Матовая полировка



## Пескоструйная обработка



## Серебрение

Стальные приборы :33 или 40 микрон.



## Золочение



## Покрyтие, нанесённое осаждением паров (PVD) Антрацит













## Покрyтие, нанесённое осаждением паров (PVD) Золото



Допускается контакт с пищевыми продуктами- Устойчивое к царапинам-Мин. 400 моек в посудомоечной машине.

Допускается контакт с пищевыми продуктами- Устойчивое к царапинам-Мин. 400 моек в посудомоечной машине.



1		table fork	fourchette table	tafelvork	Tafelgabel	forchetta da tavola	tenedor de mesa	widelec	столовая вилка	επιτραπέζιο πιρούνι
2		table spoon	cuillère table	tafellepel	Tafellöffel	cucchiaio da tavola	cuchara de mesa	łyżka stołowa	столовая ложка	επιτραπέζιο κουτάλι
5		table knife SH	couteau table MB	tafelmes monobloc	Tafelmesser monobloc	coltello da tavola impugnatura piena	cuchillo de mesa	nóż stołowy z litą rączką	столовый нож с массивной ручкой	επιτραπέζιο μαχαίρι με συμπαγή λαβή
51		table knife HH	couteau table MC	tafelmes holheft	Tafelmesser HH	coltello da tavola a manico cavo	cuchillo de mesa MH	nóż stołowy z pustą rączką	столовый нож ПР	επιτραπέζιο μαχαίρι με κοίλη λαβή
14		dessert fork	fourchette dessert	dessertvork	Dessertgabel	forchetta da dolce	tenedor de postre	widelczyk deserowy	десертная вилка	πιρούνι επιδορπίου
15		dessert spoon	cuillère dessert	dessertlepel	Dessertlöffel	cucchiaio da dolce	cuchara de postre	łyżeczka deserowa	десертная ложка	κουτάλι επιδορπίου
6		dessert knife SH	couteau dessert MB	dessertmes monobloc	Dessertmesser monobloc	coltello da dolce impugnatura piena	cuchillo de postre	nóż deserowy z litą rączką	десертный нож с массивной ручкой	μαχαίρι επιδορπίου με συμπαγή λαβή
61		dessert knife HH	couteau dessert MC	dessertmes holheft	Dessertmesser HH	coltello da dolce a manico cavo	cuchillo de postre MH	nóż deserowy z pustą rączką	десертный нож ПР	μαχαίρι επιδορπίου με κοίλη λαβή
3		tea spoon	cuillère à café	koffielepel	kaffeelöffel	cucchiaio da tè	cuchara de café	łyżeczka do kawy	набор для раздачи рыбы (вилка)	κουτάλι τσαγιού
26		mocca spoon	cuillère moka	mokkalepel	Mokkalöffel	cucchiaio da caffè	cuchara de moka	łyżeczka do mokki	Чайная ложка	κουτάλι demi-tasse
4		cake fork	fourchette gâteau	taartvorkje	Kuchengabel	forchetta da torta	tenedor de pastel	widelczyk do ciasta	вилка для торта	πιρούνι γλυκού
16		fish fork	fourchette poisson	visvork	Fischgabel	forchetta da pesce	tenedor pescado	widelec do ryby	вилка для рыбы	πιρούνι ψαριού
17		fish knife	couteau poisson	vismes	Fischmesser	coltello da scalco	cuchillo pescado	nóż do ryby	нож для рыбы	μαχαίρι ψαριού
33		soup spoon	cuillère à consommé	bouillonlepel	Kraftbrüheleffel	cucchiaio da brodo	cuchara consomé	łyżka do bulionu	супная ложка	κουτάλι ζωμού
40		fruit/butter knife	couteau fruit/beurre	fruit/botermes	Früchte/Buttermesser	coltello per burro/frutta	cuchillo de frutas/mantequilla	nóż do owoców/masła	Ложка для супа	μαχαίρι φρούτου/βούτύρου
45		steak knife	couteau steak	steakmes	Steakmesser	coltello da bistecca	cuchillo de carne	nóż do steków	нож для бифштекса	μαχαίρι μπριζόλας
25		cocktail spoon	cuillère cocktail	cocktaillepel	Limonadenleffel	cuchiaino da cocktail	cuchara de còctel	łyżeczka do koktajlu	ложка для коктейля	κουτάλι κοκτέιλ
18		ice cream spoon	pelle à glace	ijslepeltje	Eisleffel	cucchiaio da gelato	cuchara helados	łyżka do lodów	ложка для мороженого	κουτάλι παγωτού
19		oyster fork	fourchette à huîtres	oestervork	Austerngabel	forchetta da ostrica	tenedor de ostra	widelec do ostryg	вилка для устриц	πιρούνι στρειδιών
20		snail fork	fourchette à escargots	slakkenvork	Schnecken-gabel	forchetta per lumache	tenedor caracol	widelczyk do ślimaków	вилка для улиток	πιρούνι σαλιγκαριών
32		tasting spoon	cuillère à dégustation	degustatielepel	Gourmetleffel	cucchiaio da assaggio	cuchara degustación	łyżeczka do degustacji	гастрономическая ложка	κουτάλι γευστηγώσιας
34		zakouski spoon	cuillère zakouski	zakouskilepel	Zakouskilöffel	cucchiaio zakouski	cuchara zakouski	łyżka do zakąsek	ложка для закусок	κουτάλι ορεκτικών Zakouski
7		soup ladle	louche	pollepel	Suppenschöpfer	mestolo per zuppa	cucharón	chochla	поварешка	κουτάλα σούπας
8		cake server	pelle à tarte	taartschep	Tortenheber	paletta per dolce	pala de tarta	łopatka do ciasta	Половник	σπάτουλα για τάρτες
9		chips server	pelle à frites	frittenschep	Frittenleffel	paletta per patatine fritte	cuchara para fritas	łopatka do frytek	ложка для раздачи чипсов	φτυαράκι για τηγανητές πατάτες
10		salad server	service salade	slabestek	Salatbesteck	posate per insalata	servicio ensalada	złuziáce do salaty	набор для салата	σετ σερβιρίσματος σαλάτας
11		gravy ladle	cuillère à sauce	sauslepel	Saucenleffel	mestolo per salse	cazo de salsa	łyżka do sosu	ложка для подливки	κουτάλα σάλτσας
12		serving spoon	cuillère service	opdienlepel	Servierleffel	cucchiaio da servizio	cuchara servicio	łyżka wazowa	раздаточная ложка	κουτάλι σερβιρίσματος
21		serving fork	fourchette service	opdienvork	Aufschnittgabel	forchetta da servizio	tenedor servicio	widelec do serwowania	раздаточная ложка	πιρούνι σερβιρίσματος
23		carving fork	fourchette à découper	voorsnijvork	Tranchiergabel	forchettone	tenedor para trincar	widelec do mięs	вилка для разделки	πιρούνι κοψίματος κρέατος
24		carving knife	couteau à découper	voorsnijmes	Tranchiermesser	coltello da scalco	cuchillo para trincar	nóż do mięs	нож для разделки	μαχαίρι κοψίματος κρέατος
27b		butter knife	couteau beurre	botermes	Buttermesser monobloc	coltello da burro	cuchillo mantequilla	nóż do masła z litą rączką	нож для масла с массивной ручкой	μαχαίρι βούτύρου με συμπαγή λαβή
27		butter knife HH	couteau tartineur MC	botersmeermes	Buttermesser	coltello da burro con impugnatura piena	cuchillo mantequilla MH	nóż do masła z pustą rączką	нож для масла с полпой ручкой (ПР)	μαχαίρι βούτύρου
28		cheese knife	couteau fromage	kaasmes	Käsemesser	coltello da formaggio a manico cavo	cuchillo queso MH	nóż do sera z pustą rączką	нож для сыра ПР	μαχαίρι τυριού με κοίλη λαβή
29		cake knife	couteau tarte	taartmes	Tortenmesser	coltello da torta a manico cavo	cuchillo pastel MH	nóż do ciast z pustą rączką	нож для торта ПР	μαχαίρι γλυκού με κοίλη λαβή
30		fish serving fork	fourchette service poisson	visserveervork	Fischservice (Gabel)	forchetta per servire il pesce	tenedor de servicio pescado	widelec do serwowania ryby	набор для раздачи рыбы (вилка)	πιρούνι σερβιρίσματος ψαριού
31		fish serving knife	couteau service poisson	visserveermes	Fischservice (Messer)	coltello per servire il pesce	cuchillo de servicio pescado	nóż do serwowania ryby	набор для раздачи рыбы (нож)	μαχαίρι σερβιρίσματος ψαριού



eternum   
created 1924



19, rue de la Posterie  
5030 Gembloux  
Belgium  
Tel.: +32 (0)81-61 25 32  
Fax: +32 (0)81-61 33 00  
[www.eternum.com](http://www.eternum.com)

