



Martellato



Le tue specialità, la nostra passione.



LA STORIA	THE HYSTORY	Pg 2
PERSONALIZZAZIONI	CUSTOMIZATION	Pg 4
CIOCCOLATO E ACCESSORI	CHOCOLATE AND ACCESSORIES	Pg 6
STAMPI SEMIFREDDO E COTTURA	MOULDS FOR SEMIFREDDOS AND BAKING	Pg 138
GELATO E ACCESSORI	ICE-CREAM AND ACCESSORIES	Pg 184
ATTREZZATURA E ACCESSORI PER PASTICCERIA	EQUIPMENT AND ACCESSORIES FOR PASTRY	Pg 210
DECORAZIONI E COLORANTI	DECORATIONS AND COLOURS	Pg 290
MONOUSO E TAKE AWAY	DISPOSABLE AND TAKE AWAY	Pg 316
CONTENITORI ISOTERMICI e PLASTICA	CONTAINERS ISOTHERMAL and PLASTIC	Pg 346
DISPLAY E CATERING	DISPLAYS AND CATERING	Pg 354
ALZATE PER DOLCI E SALATI	CAKE STANDS FOR SWEET AND SAVOURY FOODS	Pg 390
INDICE	INDEX	Pg 418

AN ITALIAN HISTORY FROM THE 70S

Martellato: l'innovazione al servizio della passione e della creatività nella gastronomia.

Martellato è un'impresa italiana specializzata nella produzione e distribuzione di strumenti professionali per pasticceri, panettieri e gelatai. Nel tempo la gamma si è arricchita fino a comprendere soluzioni dedicate al settore Horeca e al cake design.

Stampi in plastica e silicone, alzate porta torta, stampi e attrezzature per la lavorazione del cioccolato, del pane e della pasta zucchero... **con oltre settemila articoli**, molti dei quali in pronta consegna e personalizzabili, c'è davvero l'imbarazzo della scelta.



Martellato: innovation supporting passion and creativity in cooking.

Martellato is an Italian company specialized in the production and distribution of professional equipment for pastry chefs, bakers and ice-cream makers. The product range has been expanded over the time to include solutions for the Horeca sector, cake designers and homemade pastry lovers.

Silicone moulds, cake stands, processing equipment for bread, pasta and chocolate, etc... **with more than seven thousand products**, most of them offering prompt delivery and customized solutions, there is really an embarrassing wealth of options.



Tra i fattori che hanno decretato il successo di Martellato vi sono il design, la qualità, l'innovazione e l'assortimento. L'Ufficio Commerciale opera in sinergia con il Dipartimento Ricerca & Sviluppo per diversificare ed estendere la gamma, proponendo regolarmente soluzioni inedite che anticipano i trend del mercato. Quasi tutti gli articoli vengono prodotti internamente, **a garanzia della loro qualità e sicurezza.**

Among the factors that contribute to Martellato's success are design, quality, innovation and product assortment. The Sales Department actively collaborates with the Research & Development one in order to diversify and broaden the product range, thus offering new solutions that anticipate market trends.

All the products are manufactured in-house and this is a **guarantee of quality and safety.**

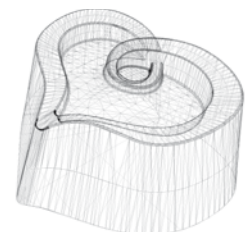

L'azienda nasce più di trent'anni fa come una piccola attività familiare, per affermarsi presto in Europa, Nord Africa, Americhe e Medio Oriente, grazie anche ad una diffusa rete di distributori.

Prestigiose industrie del settore alimentare hanno trovato in Martellato un partner d'eccellenza per la fornitura di soluzioni ad hoc perfettamente integrabili nella struttura produttiva.

The company was established more than thirty years ago as a family-run business and it has soon made its name known in Europe, North Africa, Americas and Middle East, also thanks to an extensive distribution network.

Many renowned companies of the food industry consider Martellato a partner of excellence for the supply of customized equipment which can perfectly be integrated into existing industrial production.



DESIGN E QUALITÀ ITALIANI

Scegliere Martellato significa contare per anni e anni su attrezzature affidabili, che vi ripagheranno presto dell'investimento.

Per noi, il "Made in Italy" va oltre l'estetica, significa innovazione, è l'identità che esprime i valori del territorio e quella particolare attenzione verso "il buon vivere" che lo contraddistingue.

ITALIAN DESIGN AND QUALITY

Choosing Martellato means counting on reliable products for years and years: your initial investment will be repaid early.



For us, the "Made in Italy" label goes beyond aesthetics, it means innovation, it is the identity that expresses the values of the country and that particular attention to "living well" that sets it apart.

CUSTOM EQUIPMENT, DESIGNED ACCORDING TO CUSTOMER'S NEEDS

Scegli un messaggio indelebile, dona ai tuoi clienti un oggetto utile e funzionale: **si ricorderanno di te.**

"La bellezza attira gli occhi ma il carattere cattura il cuore".

7000 sono i prodotti a catalogo, ma non ci accontentiamo, perché ogni cliente è unico e merita una soluzione su misura.

I nostri asset produttivi ci consentono di apportare, su richiesta, qualsiasi tipo di customizzazione: forma, dimensione, grafica, colore e molto altro.

Realizziamo articoli personalizzati dai più classici e di largo consumo, come i sac à poche, i raschietti e le spatole - sui quali stampiamo il vostro logo -, a quelli più complessi, come gli stampi in 3D per la produzione di soggetti di cioccolato. Questi ultimi possono essere modellati in ogni dettaglio, così da soddisfare tutti coloro che non si accontentano dell'offerta standardizzata e desiderano dare forma, la propria forma, alla qualità.

Combinando il nostro know-how con la conoscenza del settore del cliente, siamo in grado di progettare dei prodotti che rispecchiano l'identità di ogni specifica azienda.

Varie anime, una sola mente. Il nostro principale valore aggiunto risiede nella sinergia tra tecnici e creativi: la contaminazione dei saperi moltiplica le opportunità e ci permette di analizzare le richieste del cliente da varie sfaccettature. Dalla definizione del concept alla produzione, il committente può sempre contare su uno scambio/dialogo costruttivo con l'Ufficio tecnico che, dopo lo studio di fattibilità e i test sul campo, concretizza le sue idee in un articolo funzionale e di grande pregio estetico.

Le possibilità di personalizzazione sono vaste come la vostra fantasia: stampa serigrafica o in rilievo, incisione del logo al laser, realizzazione di stampi e altre attrezzature su progetto del cliente. E ancora lucidatura, satinatura, incisioni a laser, colorazione, stampa tampografica e stampa a caldo, nonché confezionamenti personalizzati.

Parafrasando la citazione, possiamo affermare che la qualità del prodotto attira il cliente, la sua identità lo fidelizza.

Contattateci, saremo lieti di creare il prodotto che meglio vi rappresenta.

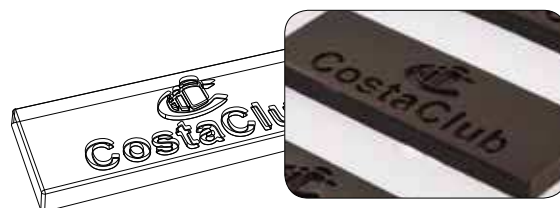

Choose an unforgettable message, give your customers a functional and useful product: they will remember you.

"Beauty attracts the eye but personality captures the heart".

There are 7,000 products in our catalogue, yet we are not satisfied, because every customer is unique and deserves a bespoke solution.

Our productive assets allow us to offer you any kind of customization upon request: shape, size, layout, colour and much more.

We personalise any product, from the most traditional and widespread, such as pastry bags, scrapers and spatulas -on which we print your logo- to the most advanced, e.g. three-dimensional moulds for the production of chocolate figures. The latter can be shaped in every detail in order to satisfy all of those who are not pleased with standardised offers and want to give shape, their own shape, to quality.

By combining our know-how with the customer's knowledge of his/her field, we are able to design products that specifically reflect the company's identity.

Different souls, a single mind: our main added value lies in the collaboration between technicians and creative talents. The combination of specialist knowledge multiplies the opportunities and allows us to analyse the customer's needs from different perspectives. From concept definition to production, the customer can always count on a constructive exchange of ideas/dialogue with the Technical department that, after the feasibility study and on-field tests, turn his/her ideas into functional and aesthetically pleasing products.

The customization possibilities with us are as vast as your imagination allows: screen and embossed printing, logo laser engraving and the production of moulds and other equipment based on the customer's project. In addition, pad printing, satinising, hot printing, laser engraving, colouring and also customised packaging.

To paraphrase the quotation, we can say that the quality of the product attracts customers, while its identity fidelizes him/her.

Feel free to contact us: we will be pleased to create the product that best represents you.

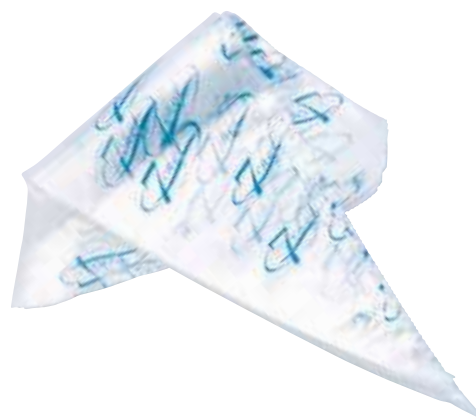

PROFESSIONAL MELTERS

MELTINCHOC ANALOGICI

I Meltinchoc sono degli strumenti indispensabili per la lavorazione del cioccolato.

Precisione, design, semplicità e ingombro ridotto sono i principali vantaggi di questi dispositivi in grado di soddisfare anche i pasticceri più esigenti.

Gli scioglitori a secco analogici sono dotati di una pratica vasca in acciaio inox removibile con scocca e coperchio in plastica.

Il termostato manuale permette di regolare e mantenere il cioccolato alla temperatura desiderata.

Realizzati in materiale plastico termoresistente, gli scioglitori per cioccolato hanno capienze comprese tra 0,8 e 13 litri.

ANALOGUE MELTINCHOC

The Meltinchoc are essential tools for chocolate processing.

Precision, design, ease of use and compactness are the main advantages of these devices, designed to meet the requirements of even the most demanding confectioners.

Dry heat analogue melters are equipped with a practical and removable stainless steel tank with plastic lid and chassis.

The manual thermostat allows you to adjust and maintain chocolate at the desired temperature.

Made with heat-resistant plastic, the chocolate melters can hold from 0,8 to 13 liters.



MeltinChoc

 MADE IN ITALY

Su richiesta disponibili scioglitori con cablaggio GB / USA / GIAPPONE / AUSTRALIA / CINA.
UK / US / JAPAN / AUSTRALIA / CHINA wirings available upon request.

0,8x3 L

Misure - Size:
39,5x26,5 h13,5cm
Vasca - Basin:
15x8,3 h10cm

Cod. **MC107**



1,5 L

Misura - Size:
24x26 h13,5cm
Vasca - Basin:
15,5x14 h10cm

Cod. **MC105**



1,5x2 L

Misura - Size:
26x42 h13,5cm
Vasca - Basin:
15,5x14 h10cm

Cod. **MC108**



1,5x3 L

Misura - Size:
26x61 h13,5cm
Vasca - Basin:
15,5x14 h10cm

Cod. **MC100**



1,5x4 L

Misura - Size:
79x26 h13,5cm
Vasca - Basin:
15,5x14 h10cm

Cod. **MC106**



3,6 L

Misura - Size:
40x24 h13,5cm
Vasca - Basin:
32,5x18 h10cm

Cod. **MC101**



6 L

Misura - Size:
40x33 h13,5cm
Vasca - Basin:
32x26,5 h10cm

Cod. **MC102**



9 L

Misura - Size:
45x39,5 h13,5cm
Vasca - Basin:
35,3x32 h10cm

Cod. **MC103**



13,7 L

Misura - Size:
62x39,5 h13,5cm
Vasca - Basin:
53x32,5 h10cm

Cod. **MC104**



MINI MELTERS

Lo scioglitore a secco per cioccolato MINI-MELTIN-CHOC può essere utilizzato sia in laboratorio per piccole produzioni di praline e soggetti di cioccolato che in gelateria per la copertura di gelati e dessert su stecco.

Il design raffinato incentiva l'esposizione dello scioglitore in negozio favorendone l'utilizzo anche di fronte al pubblico.

Realizzato in robusto materiale plastico antiurto. Vaschetta estraibile in alluminio anodizzato.

MINI-MELTINCHOC dry heat chocolate melters can be used for small productions of pralines and chocolate shapes, as well as in the ice-cream shops for the decorations of ice creams.

Because of its modern design, the melter can be used also in the shop in front of the customers.

Made of durable impact resistant plastic.

Removable basin made of anodized aluminium.



Mini MeltinChoc

MADE IN ITALY



Consigli per il temperaggio del cioccolato con il Mini MeltinChoc

Impostare la massima temperatura sul Mini MeltinChoc e sciogliere il 70% del cioccolato mescolando frequentemente.

Quando il cioccolato è perfettamente fuso e ha raggiunto la temperatura di 40-45°C abbassare a 30°C il termostato del Mini MeltinChoc e aggiungere il restante 30% di cioccolato a temperatura ambiente. Mescolare per amalgamare e raffreddare fino al raggiungimento della temperatura di "temperaggio" consigliata dal produttore del cioccolato (la temperatura di temperaggio è indicativamente di 31°C per il cioccolato fondente, di 30°C per il cioccolato al latte e di 29°C per il cioccolato bianco).

Questa tecnica è definita "temperaggio per inseminazione" e serve a stabilizzare i cristalli del burro di cacao. Per un temperaggio preciso consigliamo di misurare la temperatura con il termometro digitale Martellato per cioccolato (cod. 50T001).

Il cioccolato ben temperato si sforma facilmente dagli stampi e ha un aspetto invitante, lucido e croccante, al contrario se il cioccolato non è temperato, è difficile da sformare e oltre a essere opaco e molle potrebbe presentare venature biancastre.

Suggestions for chocolate tempering with the Mini MeltinChoc

Set the maximum temperature on the Mini MeltinChoc and melt the 70% of chocolate, stirring frequently.

When chocolate is completely melted and has reached a temperature of 40-45 °C, lower the thermostat of the Mini MeltinChoc to 30° C and add remaining 30% of chocolate at room temperature.

Stir to mix and cool down to the "tempering" temperature recommended by the chocolate manufacturer (tempering temperature is approximately 31 °C for dark chocolate, 30 °C for milk chocolate and 29 °C for white chocolate).

This technique is called "tempering for insemination" and it is useful to stabilize the crystals of cocoa butter. For a precise tempering, it is recommended to measure the temperature with Martellato digital thermometer for chocolate (cod. 50T001).

Well-tempered chocolate can be easily removed from the moulds; it is crispy and looks shiny and attractive. On the contrary, not-tempered chocolate is difficult to unmould and it may have whitish veins, besides being soft and opaque.

1,8 L

Misure - Size:
26x26 h16 cm
Vasca - Basin:
Ø18,5 h10,7 cm
Cap. 1,8 LT



Cod. **MC09G**
Grigio - Gray



Cod. **MC09L**
Lilla - Lilac



Cod. **MC09R**
Rosso - Red



Cod. **MC09V**
Verde - Green

Cod. **MC000305**
Vaschetta in alluminio anodizzato.
Basin made of anodized aluminium.
Basin: Ø18,5 h10,7 cm
Cap. 1,8 LT



DIGITAL MELTERS

Realizzato in materiale plastico termoresistente, con vasca e coperchio in acciaio inox removibile. Il termostato digitale e la speciale sonda siliconica posizionata all'interno della vasca e immersa nel prodotto, permettono di impostare e mantenere con precisione la temperatura desiderata. 220 V o 110 V.

Made of thermoresistant plastic material. Removable stainless steel basin and lid with digital thermostat and a special auger, which is placed inside the basin and dip into the chocolate, it is possible to set the temperature and check it constantly. 220 V or 110 V.

3,6 L

Misura - Size:
46x23 h13,5cm
Vasca - Basin:
32,5x18 h10cm

Cod. **MCD01**



6 L

Misura - Size:
50x33 h13,5cm
Vasca - Basin:
32x26,5 h10cm

Cod. **MCD02**



9 L

Misura - Size:
46x38 h13,5cm
Vasca - Basin:
35,3x32 h10cm

Cod. **MCD03**



13,7 L

Misura - Size:
68x38 h13,5cm
Vasca - Basin:
53x32,5 h10cm

Cod. **MCD04**



CHOCOLATE FOUNTAINS

Fontana professionale in grado di produrre una scenografica colata di morbido cioccolato. Facile da usare e pulire, è l'ideale per catering, feste e matrimoni, oltre a rappresentare un suggestivo complemento d'arredo per le pasticcerie.

Professional fountain capable to produce a spectacular "waterfall" of soft chocolate. Easy to use and clean, it is the ideal solution for caterings, parties and weddings. Besides, it is a visually-striking furniture item for pastry shops.



Fontane per cioccolato realizzate in acciaio inox, temperatura regolabile
Fountain made of stainless steel, adjustable temperature



Cod. CHOCOFONT

Ø 210mm h390mm
220 - 240V - 50 Hz
Amps 0,77A - 170W

Realizzata in acciaio inox.
Perno centrale in materiale plastico resistente ad alte temperature.
Mantiene la cioccolata alla temperatura di 36/39°C.
Facile da usare e da pulire.

Made of stainless steel.
The auger is made of heat resistant plastic.
To keep chocolate at 36/39°C.
Easy to use and clean.



Cod. CHOCOBIG

Ø380 h800 mm
230V - 50 Hz
Amps 1.6A - 370W

Realizzata in acciaio inox.
Perno centrale in acciaio, resistente ad alte temperature.
Mantiene la cioccolata alla temperatura di 36/39°C.
Facile da usare e da pulire.

Made of stainless steel.
The auger is made of stainless steel.
To keep chocolate at 36/39°C.
Easy to use and clean.



Cod. 20-4000

Ø 440 h1000 mm
Capacità Vasca : circa 9 litri
230V - 50/60 Hz
Amps : 2,5A - 450W

Realizzata in acciaio inox.
Perno centrale in acciaio, resistente ad alte temperature.
Mantiene la cioccolata alla temperatura di 36/39°C.
Facile da usare e da pulire.

Made of stainless steel.
The auger is made of stainless steel.
To keep chocolate at 36/39°C.
Easy to use and clean.



Cod. CHOCORING

Rosso - Red

Cod. CHOCORING06

Satinato - Glazed

Ø 520mm x h 160mm
per/for CHOCOFONT.

Copri fontana con comodi ripiani portacoppette.
In plexiglass forma rotonda.

Ring cover for Chocofont with useful displayers.
Round shaped plexiglass shelves.

Cod. CHOCOBIGRING

Rosso - Red

Cod. CHOCOBIGRING06

Satinato - Glazed

Ø650 mm x h 170mm
per/for CHOCOBIG.

Copri fontana con comodi ripiani portacoppette.
In plexiglass forma rotonda.

Ring cover for Chocofont with useful displayers.
Round shaped plexiglass shelves.

Cod. 20-R4000

Satinato - Glazed

810x810 h 165 mm
per/for 20-4000 20-4001,

Copri fontana con comodi ripiani portacoppette.
In plexiglass satinato forma ovalizzata.
Ring cover for Chocofont with useful displayers.
Oval shaped satinized plexiglass shelves

PRALINE MOULDS

La qualità del policarbonato utilizzato per la produzione degli stampi Martellato, garantisce un'ottimale produzione di soggetti e praline di cioccolato dall'indubbia lucentezza ed eleganza.

The quality of the polycarbonate used to produce Martellato moulds assures the best production of bright and elegant shapes and chocolate pralines. Stampo - Mould: 275x175 mm

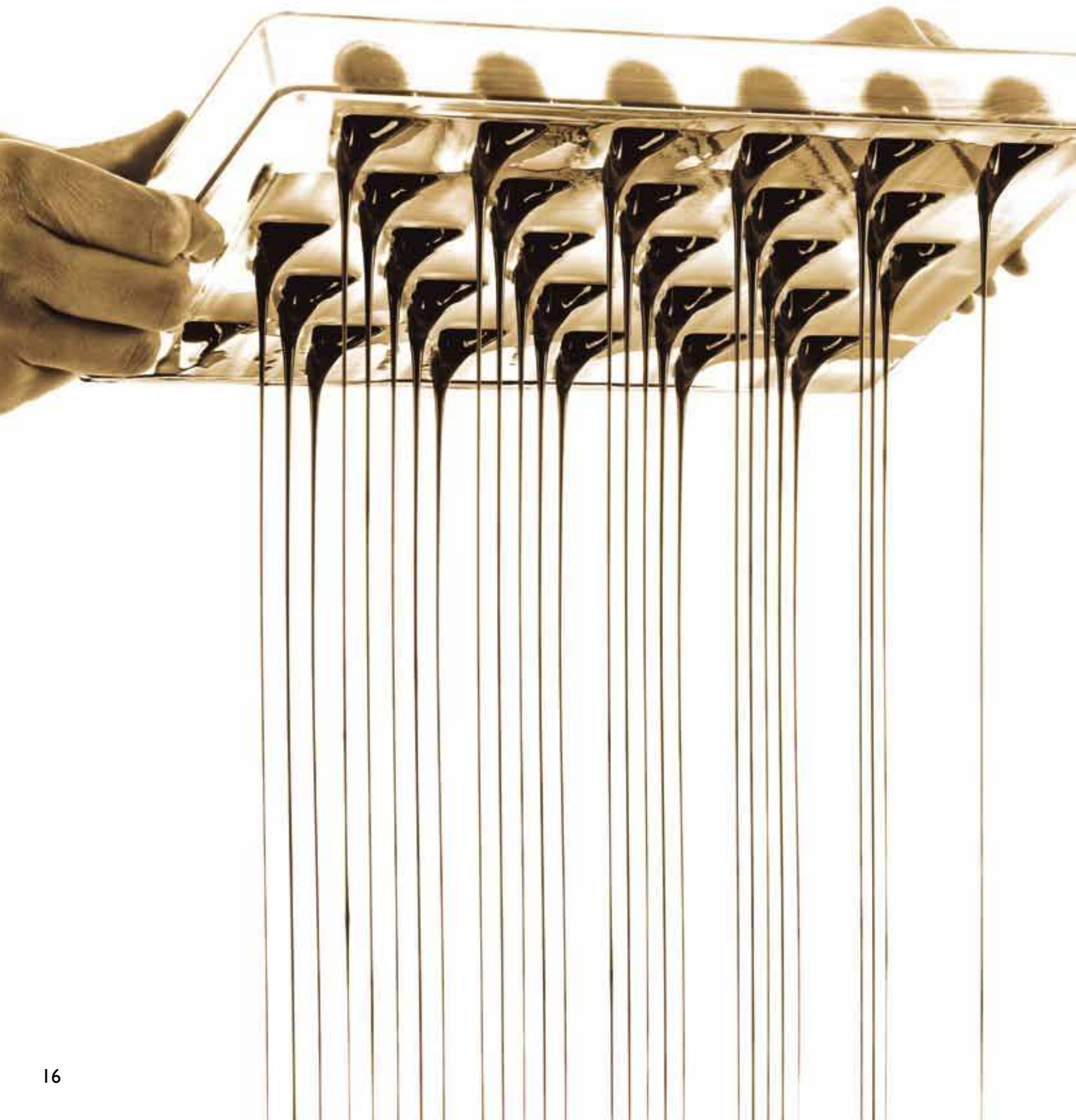



new

Cod. **MA1980**
24 pcs 25x25 h13mm
9 gr approx

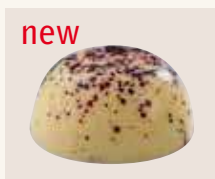

new

Cod. **MA1981**
24 pcs Ø35 h15mm
11 gr approx



new

Cod. **MA2006**
16 pcs 50x26 h3mm
5 gr approx



new

Cod. **MA2007**
12 pcs 74x33 h5mm
13 gr approx



Cod. **MA1002**
28 pcs Ø30 h19mm
12 gr approx



Cod. **MA1019**
40 pcs 25x25 h23mm
13 gr approx



Cod. **MA1025**
30 pcs 33x22 h20mm
15 gr approx



Cod. **MA1029**
32 pcs 39x28 h17mm
12 gr approx



Cod. **MA1032**
32 pcs 38x22 h15mm
10 gr approx

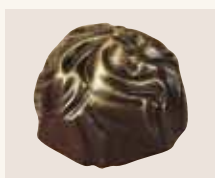

Cod. **MA1037**
40 pcs Ø29 h21mm
8 gr approx

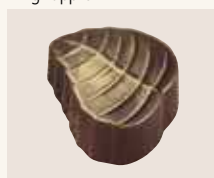

Cod. **MA1046**
28 pcs 37x31 h16mm
14 gr approx

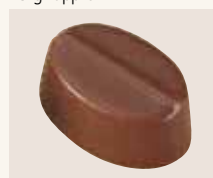

Cod. **MA1064**
36 pcs 35x23 h16mm
9 gr approx

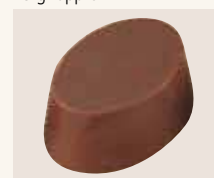

Cod. **MA1074**
30 pcs 38x28 h18mm
15 gr approx



Cod. **MA1082**
30 pcs 35x20 h17mm
12 gr approx



Cod. **MA1088**
32 pcs 39x26 h19mm
14 gr approx

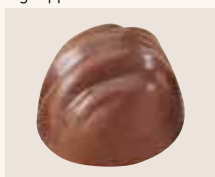

Cod. **MA1091**
40 pcs Ø28 h24mm
11 gr approx

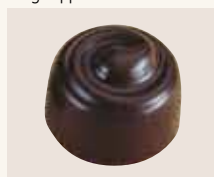

Cod. **MA1094**
28 pcs Ø30 h22mm
14 gr approx

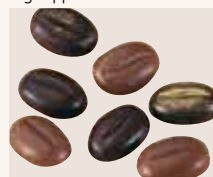

Cod. **MA1281**
130 pcs 17x12 h5mm
1 gr approx

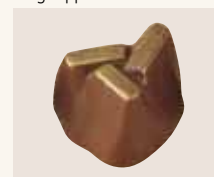

Cod. **MA1293**
28 pcs Ø23 h21mm
12 gr approx



Cod. **MA1303**
28 pcs 27x27 h18mm
11 gr approx

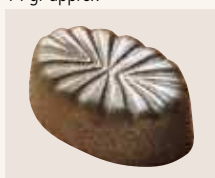

Cod. **MA1335**
30 pcs 35x22 h15mm
7 gr approx



Cod. **MA1350**
30 pcs Ø28 h25mm
11 gr approx

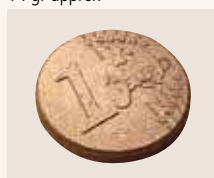

Cod. **MA1467**
24 pcs Ø34 h4mm
4 gr approx

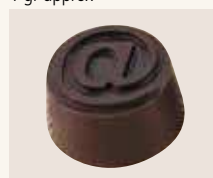

Cod. **MA1493**
28 pcs Ø28 h16mm
10 gr approx

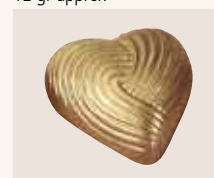

Cod. **MA1513**
28 pcs 34x33 h11mm
7 gr approx

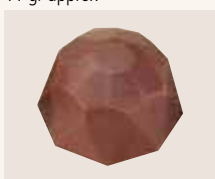

Cod. **MA1521**
28 pcs Ø28 h18mm
10 gr approx

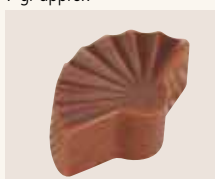

Cod. **MA1525**
42 pcs 31x26 h15,5mm
9 gr approx

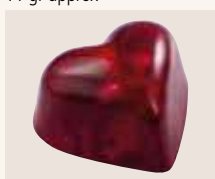

Cod. **MA1526**
35 pcs 34,7x22 h16mm
8 gr approx



Cod. **MA1527**
35 pcs 31x24 h13mm
8 gr approx

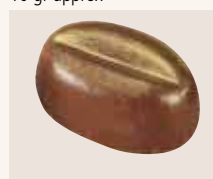

Cod. **MA1529**
42 pcs 32x22 h15mm
8 gr approx

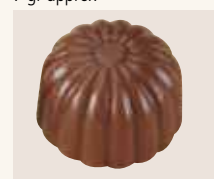

Cod. **MA1530**
40 pcs Ø26 h19mm
9 gr approx

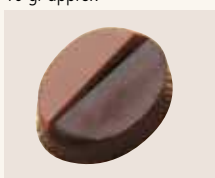

Cod. **MA1602**
20 pcs 35x27 h12mm
9 gr approx



Cod. **MA1603**
24 pcs 32x23 h13mm
8 gr approx



Cod. **MA1604**
24 pcs 30x25 h15mm
9 gr approx

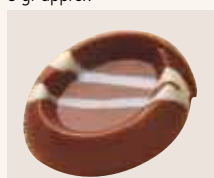

Cod. **MA1605**
15 pcs 40x32 h11mm
7 gr approx



Cod. **MA1606**
24 pcs 30x30 h12mm
9 gr approx

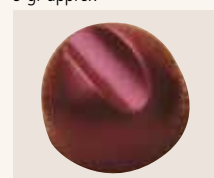

Cod. **MA1607**
24 pcs Ø27 h17mm
9 gr approx



Cod. **MA1608**
20 pcs 33x25 h12mm
9 gr approx

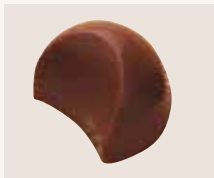

Cod. **MA1609**
24 pcs 30x23 h18mm
9 gr approx

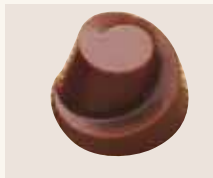

Cod. **MA1610**
24 pcs Ø29 h18mm
9 gr approx



Cod. **MA1611**
24 pcs Ø30 h15mm
9 gr approx



Cod. **MA1612**
20 pcs 38x30 h15mm
9 gr approx



Cod. **MA1613**
15 pcs 40x42 h15mm
9 gr approx



Cod. **MA1614**
24 pcs 30x24 h12mm
8 gr approx



Cod. **MA1615**
20 pcs 38x25 h12mm
9 gr approx



Cod. **MA1616**
28 pcs 27x27 h13mm
9 gr approx



Cod. **MA1617**
24 pcs 31x23 h12mm
9 gr approx

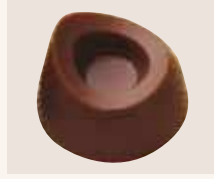

Cod. **MA1618**
24 pcs Ø30 h20mm
9 gr approx



Cod. **MA1619**
18 pcs 29x29 h12mm
- gr approx

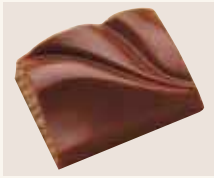

Cod. **MA1620**
24 pcs 33x25 h12mm
8 gr approx



Cod. **MA1621**
24 pcs 33x33 h15mm
9 gr approx



Cod. **MA1622**
24 pcs 30x24 h12mm
9 gr approx



Cod. **MA1623**
20 pcs 40x30 h12mm
9 gr approx



Cod. **MA1624**
32 pcs 28x32 h15mm
8 gr approx



Cod. **MA1625**
30 pcs 30x18 h15mm
8 gr approx



Cod. **MA1626**
30 pcs 31x20 h16mm
7 gr approx



Cod. **MA1627**
30 pcs 35x20 h15mm
7 gr approx



Cod. **MA1628**
30 pcs 30x18 h15mm
7 gr approx



Cod. **MA1629**
30 pcs 30x18 h15mm
8 gr approx



Cod. **MA1630**
30 pcs 30x18 h15mm
8 gr approx



Cod. **MA1631**
30 pcs 30x18 h15mm
7 gr approx



Cod. **MA1632**
30 pcs 30x18 h15mm
8 gr approx



Cod. **MA1633**
35 pcs Ø26 h15mm
8 gr approx



Cod. **MA1634**
30 pcs 32x19 h15mm
7 gr approx



Cod. **MA1635**
30 pcs 32x22 h15mm
7 gr approx

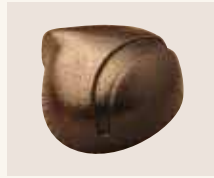

Cod. **MA1636**
24 pcs 30x30 h15mm
8 gr approx



Cod. **MA1637**
30 pcs 32x24 h15mm
8 gr approx



Cod. **MA1638**
30 pcs 34x25 h15mm
8 gr approx



Cod. **MA1640**
16 pcs 48x18,5 h19mm
10 gr approx



Cod. **MA1701**
35 pcs 30x25 h15mm
8 gr approx



Cod. **MA1702**
35 pcs 30x25 h14mm
8 gr approx



Cod. **MA1703**
35 pcs 30x25 h14mm
8 gr approx



Cod. **MA1704**
35 pcs 30x25 h15mm
9 gr approx



Cod. **MA1705**
35 pcs 30x25 h14mm
9 gr approx



Cod. **MA1706**
35 pcs 31x26 h14mm
9 gr approx

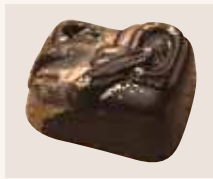

Cod. **MA1707**
35 pcs 30x25 h14mm
9 gr approx



Cod. **MA1800**
28 pcs 22x22 h22mm
8 gr approx



Cod. **MA1801**
28 pcs 26x20 h21mm
8 gr approx



Cod. **MA1802**
28 pcs Ø24 h21mm
7 gr approx



Cod. **MA1803**
28 pcs 26x20 h21mm
8 gr approx



Cod. **MA1804**
28 pcs Ø25 h18,5mm
7 gr approx



Cod. **MA1900**
28 pcs 29x19 h16mm
8 gr approx



Cod. **MA1901**
28 pcs 27x23 h14mm
8 gr approx



Cod. **MA1902**
28 pcs 26x19 h16mm
7 gr approx



Cod. **MA1903**
28 pcs 28x20 h17mm
7 gr approx



Cod. **MA1904**
28 pcs 30x20 h17,5mm
8 gr approx



Cod. **MA1905**
28 pcs 30,5x19,5 h18mm
8 gr approx



Cod. **MA1906**
28 pcs 30x19 h17mm
8 gr approx



Cod. **MA1907**
28 pcs 29,5x19 h17mm
7 gr approx



Cod. **MA1908**
28 pcs 26,5x22,5 h16,5mm
7 gr approx



Cod. **MA1909**
28 pcs 27,5x19,5 h17mm
8 gr approx



Cod. **MA1958**
5x7 pcs 30x24 h17mm
7 gr approx



Cod. **MA1959**
5x7 pcs 30x24 h17mm
7 gr approx



Cod. **MA1960**
35 pcs 30x25 h15mm
6 gr approx



Cod. **MA1961**
5x6 pcs 30x25 h25mm
8 gr approx



Cod. **MA1962**
30 pcs 31x27 h14mm
8 gr approx



Cod. **MA1963**
30 pcs Ø27 h20mm
7 gr approx



Cod. **MA1964**
30 pcs Ø27 h20mm
7 gr approx



Cod. **MA1965**
30 pcs 25x25 h15mm
7 gr approx



Cod. **MA1966**
30 pcs 25x25 h15mm
9 gr approx



Cod. **MA1967**
30 pcs 25x25 h15mm
9 gr approx



Cod. **MA1968**
30 pcs 25x25 h15mm
7 gr approx



Cod. **MA1969**
30 pcs 40x20 h18mm
8 gr approx

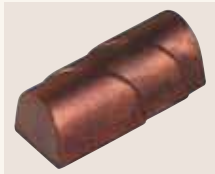

Cod. **MA1970**
30 pcs 40x18 h15mm
9 gr approx



Cod. **MA1971**
30 pcs 40x18 h16mm
8 gr approx



Cod. **MA1972**
30 pcs 26x26 h20mm
7 gr approx



Cod. **MA1973**
5x6 pcs 30x24 h20mm
7 gr approx

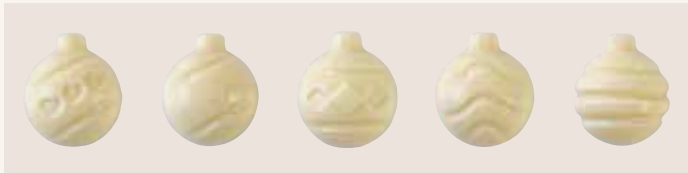

Cod. **MA1974**
5x6 pcs 30x26 h16,5mm
7 gr approx



Cod. **MA1975**
5x6 pcs 31x22 h22mm
7 gr approx

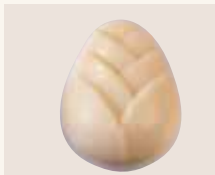

Cod. **MA1976**
32 pcs 33x26 h17mm
8 gr approx

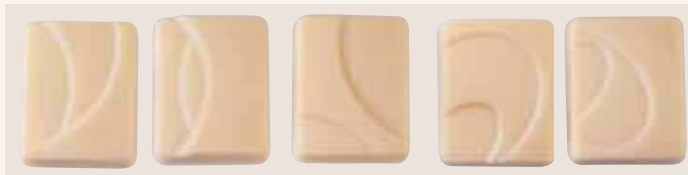

Cod. **MA1977**
5x6 pcs 30x24 h11mm
7 gr approx



Cod. **MA1978**
3x8 pcs 30x32 h5mm
5 gr approx



Cod. **MA1979**
5x6 pcs 33x24 h18mm
8 gr approx



Cod. **MA2002**
24 pcs 32x32 h4mm
5 gr approx



Cod. **MA2003**
28 pcs 20x20 h16mm
6 gr approx

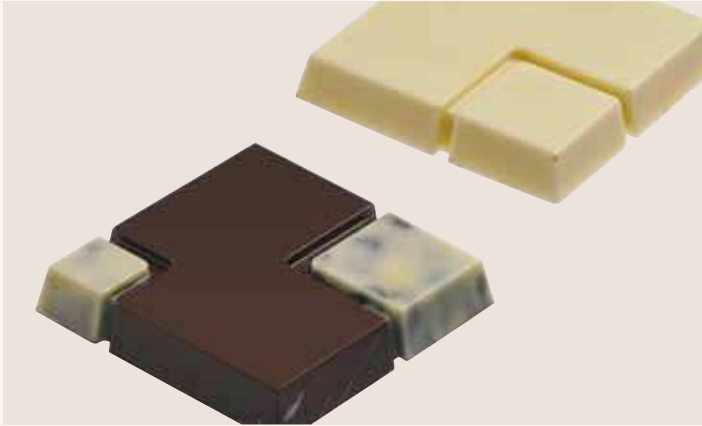

Cod. **MA1805**
8 pcs 58x58 h10mm
35 gr approx

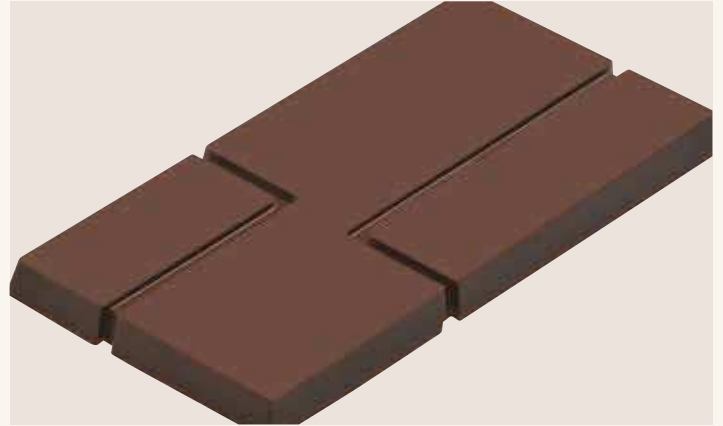

Cod. **MA1807**
3 pcs 154x74 h10mm
124 gr approx



Cod. **MA1700**
6 pcs 110x37 h10mm
25 gr approx

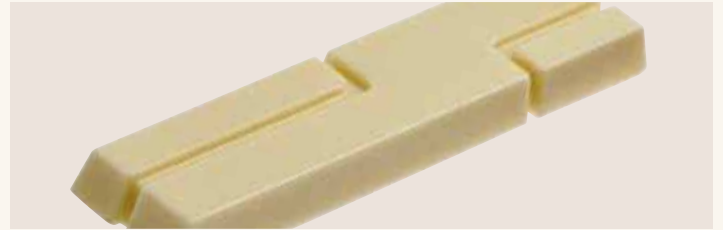

Cod. **MA1806**
8 pcs 119x29 h10mm
35 gr approx



Cod. **MA1910**
8 pcs 99x33 h10mm
32 gr approx



Cod. **MA1911**
8 pcs 103x29 h12,5mm
36 gr approx



Cod. **MA1912**
8 pcs 112x32,5 h15,5mm
33 gr approx



Cod. **MA1913**
8 pcs 119x29 h10mm
34 gr approx



Cod. **MA2000**
3 tav./ bars 150x70 h11mm
114 gr approx



Cod. **MA2001**
3 tav./ bars 160x75 h8mm - 95gr
110 gr approx



Cod. **MA2004**
4 tav./ bars 130x55 h8mm - 60gr
67 gr approx



Cod. **MA2005**
3 tav./ bars 159x80 h9mm - 75gr
64 gr approx

MOULDS FOR SUBJECTS

Stampi professionali per realizzare simpatici soggetti e decorazioni di cioccolato. Lo stampo tazzina è ideale per produrre dessert monoporzione e mignon.

Professional moulds to produce chocolate subjects and decorations.

The cup mould is perfect to prepare single-serving and mignon dessert.



Tazzine - Cups

Cod. **MA1951**
7 pcs Ø59 h36 mm

Cod. **MA1953**
7 pcs Ø51 h32 mm



Piattini - Plates

Cod. **MA1952**
3 pcs Ø91 mm

Cod. **MA1954**
5 pcs Ø80 mm



Quadrante orologio - Clock face

Cod. **MA1950**
6 pcs 77x70 h10 mm



MINI CHOCO FILL MOULDS

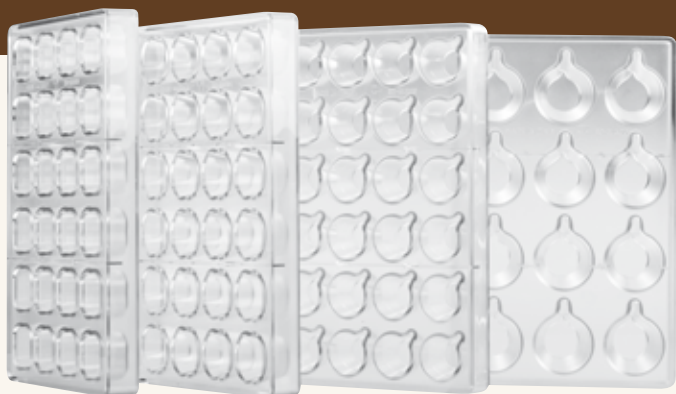

Con i Mini ChocoFill è possibile creare dei piccoli mignon o delle raffinate praline dall'aspetto originale e invitante. Using Mini ChocoFill you can prepare small mignon or refined pralines with an original and appetizing look.

Stampo policarbonato - Polycarbonate mould: 275x175 mm

MINI
Choco Fill



Cod. **20GU005**

Cap. 24 pcs

Misura - Size: 32x42 h29 mm



Cod. **20GU500**

Cap. 12 pcs

Misura - Size: 44x56 h39 mm

Cod. **20GU002**
Cap. 15 pcs
Misura - Size: Ø40 h17 mm



Cod. **20GU003**
Cap. 24 pcs
Misura - Size: 33x31 h20 mm



Cod. **20GU004**
Cap. 24 pcs
Misura - Size: 33x33 h23 mm



Cod. **20GU001**
Cap. 20 pcs
Misura - Size: Ø32 h37 mm



Cod. **ESPO20GU001**
Misura - Size: 380x100 h25 mm
Cap. 20 pcs



VINTAGE MOULDS

La pralina di cioccolato dal design moderno e minimalista lascia il posto ad un'assoluta novità dal sapore vintage.

NOSTALGIC CHOCOLATE è la nuova linea di stampi per realizzare praline di cioccolato che richiamano soggetti d'epoca: dal coinvolgente Juke Box all'amabile telefono a rotella. Otto soggetti disponibili in 4 kit da due stampi.

The modern and minimalist praline design gives way to the novelty of the vintage chocolates.

NOSTALGIC CHOCOLATE is a brand new collection of moulds aimed at making pralines that remind vintage objects, such as the enthralling jukebox or the lovely rotary dial phone.

Eight different models available in 4 kits of 2 moulds each.

Stampo - Mould: 275x175 mm



HOW TO USE





12gr



10gr

TELEFONO & ABATJOUR

TELEPHONE & LAMP

cod. **MA4000**

Kit 2 stampi - Kit 2 moulds

Misura Telefono - Telephone size: 24x34- h27mm - 12 pcs

Misura Abatjour - Lamp size: Ø27- h40mm - 16 pcs



12gr



3gr 10gr

FOTOCAMERA & VALIGIE

CAMERA & LUGGAGE

cod. **MA4001**

Kit 2 stampi - Kit 2 moulds

Misura Fotocamera - Camera size: 34x21- h30mm - 18 pcs

Misura Set Valigie - Luggage Set size: 35x13 h29 mm - 6 pcs

Misura Set Valigie - Luggage Set size: 23x10 h19 mm - 6 pcs



11gr



13gr

POLTRONA & JUKE BOX

ARMCHAIR & JUKE BOX

cod. **MA4002**

Kit 2 stampi - Kit 2 moulds

Misura Poltrona - Armchair size: 35x17- h29mm - 12 pcs

Misura Juke Box - Juke Box size: 28x16- h37mm - 12 pcs



12gr



12gr

BILANCIA & SVEGLIA

SCALE & ALARM CLOCK

cod. **MA4003**

Kit 2 stampi - Kit 2 moulds

Misura Bilancia - Scale size: 36x30- h29mm - 8 pcs

Misura Sveglia - Alarm clock size: 30x13- h40mm - 14 pcs

PRALINE 3D MOULDS

Lo stampo, realizzato in policarbonato, è composto da tre parti. La base ed il coperchio, che definiscono la forma della pralina 3D, sono dotate di calamite, per rendere possibile una resistente unione. Il terzo componente consiste invece in una placca forata, necessaria per una pratica e veloce lisciatura dello stampo, dopo lo svuotamento del cioccolato in eccesso.

Our moulds, made of polycarbonate, are composed of three parts. The base and the lid, which define the shape of 3D pralines, are both equipped with magnets, for a strong union. The third component is a little perforated plate, necessary for a practical and fast smoothing after draining the excess chocolate.

Stampo - Mould: 275x175 mm



Cod. **20-3D1001**

Ovetto - Egg
23x30 h 23 mm
28pcs - 8gr



Cod. **20-3D1002**

Ovetto - Egg
23x32 h 23 mm
28pcs - 8gr



Cod. **20-3D1003**

Ovetto - Egg
23x30 h 23 mm
28pcs - 8gr



Cod. **20-3D2001**

Sfera - Sphera
26x26 h 26 mm
28pcs - 8gr



Cod. **20-3D2002**

Sfera - Sphera
26x26 h 26 mm
28pcs - 8gr



Cod. **20-3D2003**

Sfera - Sphera
26x26 h 26 mm
28pcs - 8gr



Cod. **20-3D3001**

Sfera - Sphera
26x26 h 26 mm
28pcs - 8gr



Cod. **20-3D4001**

Sfera - Sphera
28x24 h 24 mm
28pcs - 8gr



Cod. **20-3D5001**

Cuoricino - Heart
31x27 h 21 mm
28pcs - 8gr



Cod. **20-3D6001**

Cuoricino - Heart
32x18 h 28 mm
28pcs - 8gr



HOW TO USE



1



2



3



4



5

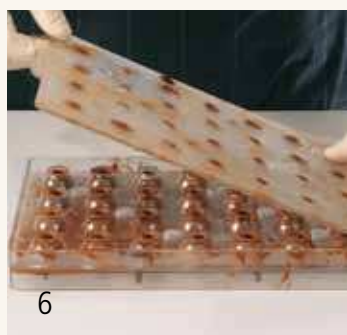

6

- 1- Unire le due parti di stampo;
- 2- Riempire gli alveoli di cioccolato con l'aiuto di una sac a poche;
- 3- Inserire la placca forata;
- 4- Svuotare il cioccolato nella Meltinchoc per creare la camicia della pralina;
- 5- Con l'aiuto di una spatola lisciare per togliere il cioccolato in eccesso;
- 6- Staccare la placca forata prima che il cioccolato cristallizzi;
- 7- Aprire lo stampo per estrarre le praline.

- 1- Combine the two parts of the mould;
- 2- Fill the alveoli with chocolate using a pastry bag;
- 3- Insert the perforated plate;
- 4- Empty the chocolate into the Meltinchoc to create the outer layer of the praline;
- 5- With the help of a spatula remove the chocolate in excess;
- 6- Remove the perforated plate before the chocolate crystallizes;
- 7- Open the mould to remove the pralines.



7

PRALINE'S DISPLAY

Queste vetrine in plexiglass sono progettate e costruite per mettere in luce cioccolatini e altre specialità dolciarie. Pratiche e resistenti, le nostre teche sono facili da pulire e da spostare.
These plexiglass showcases are designed and produced to highlight chocolates and other pastry specialities. Practical and resistant, our cases are easy to clean and move.



Accessori interni non inclusi
Internal accessories not included

Cod. **VP00101**
60x36cm - h16cm



Cod. **VP00401**
Vassoio trasparente - Transp. tray
34X11cm - h2cm

La vetrina portapraline può contenere
cinque vassoi cod. VP00401
The showcase can contain
five trays code VP00401

Cod. **VP00501**
Piatto trasparente
32X9cm - h0,2cm



Cod. **VP00700**
Vassoio bianco - white tray
18X29cm - h2,5cm

La vetrina portapraline può contenere
tre vassoi cod. VP00700
The showcase can contain
Three trays code VP00700

Cod. **VP00801**
Piatto trasparente
13X24cm - h0,2cm



Cod. **VP00500**
Vassoio bianco - White tray
32x20cm - h2,5cm



Cod. **VP00601**
Piatto trasparente
20x15cm -h0,2cm

Cod. **VP00206**
Vassoio monosatinano - Glazed tray
17x17cm - h2cm

Cod. **VP00301**
Piatto trasparente
16,5x16,5cm - h0,2cm

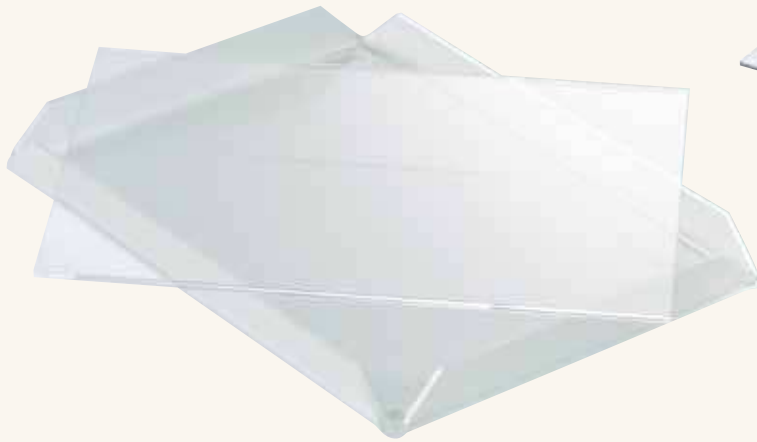

Cod. **VP01106**
Vassoio monosatinano - Glazed tray
17x23cm - h2cm

Cod. **VP01201**
Piatto trasparente
16,5x22,5cm - h0,2cm



Cod. **VP00906**
Vassoio monosatinano - Glazed tray
10x50cm - h2cm

Cod. **VP01001**
Piatto trasparente
9,5x49,5cm - h0,2cm

Alzatina in Plexiglass porta praline o mignon
Plexiglass display for pralines or mignons

Cod. **COD. 604**
22x27 h30cm



DECORATIONS MOULDS



Nuova linea stampi professionali: design e qualità made in Italy.

Progettati e realizzati con il preciso intento di fornire al pasticciere un valido strumento per produrre raffinate decorazioni di cioccolato.

Decorazioni di grande effetto che concedono ampie possibilità di interpretazione al fine di donare un tocco di unicità al dessert.

New Professional moulds line: made in Italy design and quality. Designed and produced to give pastry chefs a perfect tool to create fine chocolate decorations. Wonderful decorations to make your desserts unique.

Stampo - Mould: 275x175 mm



Si consiglia di utilizzare un cioccolato fluido.
We recommend using a liquid chocolate.



Cod. **20-D020**

Cap. 6+6+6 pcs - 2/3 gr approx
71x71 - 51x51 - 31x31 mm

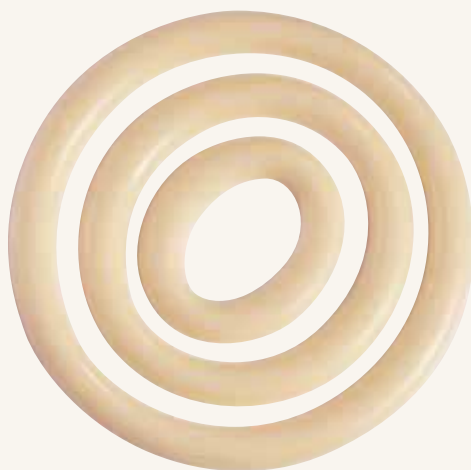

Cod. **20-D021**

Cap. 6+6+6 pcs - 2/3 gr approx
73x72 - 54x51 - 35x30 mm

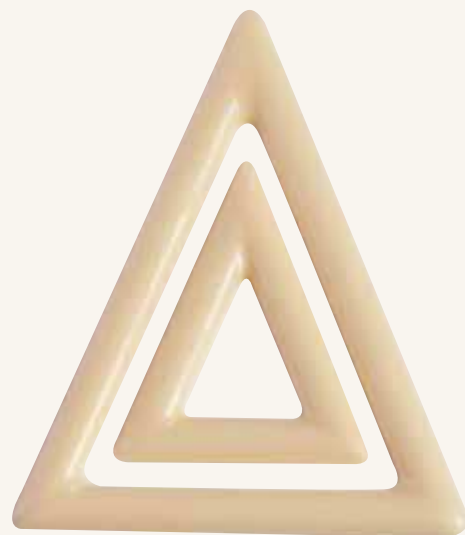

Cod. **20-D022**

Cap. 9+9 pcs - 2/3 gr approx
68x81 - 39x47 mm



Cod. **20-D023**

Cap. 6+6+6 pcs - 2/3 gr approx
66x79 - 46x58 - 28x36 mm



Cod. **20-D024**

Cap. 12 pcs - 2/3 gr approx
70x38 mm



Cod. **20-D025**

Cap. 10+10 pcs - 2/3 gr approx
73x44 - 50x24 mm

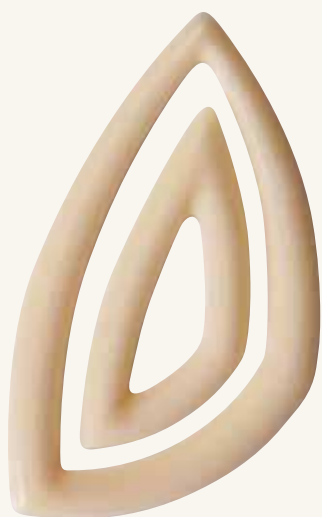

Cod. **20-D026**

Cap. 10+10 pcs - 2/3 gr approx
41x73 - 20x50 mm



Cod. **20-D027**

Cap. 6/6+6/6 pcs - 2/3 gr approx
38x72 - 33x20 mm



Cod. **20-D001**
Cap. 18 pcs - 2/3 gr approx
63x h21 mm



Cod. **20-D002**
Cap. 18 pcs - 2/3 gr approx
66x h20 mm



Cod. **20-D003**
Cap. 16 pcs - 2/3 gr approx
64x h26 mm



Cod. **20-D004**
Cap. 18 pcs - 2/3 gr approx
63x h23 mm



Cod. **20-D005**
Cap. 18 pcs - 2/3 gr approx
72x h24 mm



Cod. **20-D006**
Cap. 18 pcs - 2/3 gr approx
72x h19 mm



Cod. **20-D007**
Cap. 18 pcs - 2/3 gr approx
66x h21 mm



Cod. **20-D008**
Cap. 18 pcs - 2/3 gr approx
65x h22 mm



Cod. **20-D009**
Cap. 18 pcs - 2/3 gr approx
70x h19 mm



Cod. **20-D010**
Cap. 14 pcs - 2/3 gr approx
50 x h38 mm



Cod. **20-D015**
Cap. 12 pcs - 12 gr approx
129 x h17 mm



Cod. **20-D012**
Cap. 12 pcs - 3/4 gr approx
50 x h49 mm



Cod. **20-D013**
Cap. 15 pcs - 2/3 gr approx
47 x h39 mm



Cod. **20-D011**
Cap. 16 pcs - 2/3 gr approx
62 x h31 mm



Cod. **20-D014**
Cap. 11 pcs - 2/3 gr approx
Ø50 mm



Cod. **20-D016**
Cap. 22 pcs - 3/4 gr approx
110 x h7 mm



Cod. **20-D017**
Cap. 8+8 pcs - 2/3 gr approx
108x17 - 101x18 mm



Cod. **20-D018**
Cap. 10+10 pcs - 2/3 gr approx
125x4 - 102x17 mm



Cod. **20-D019**
Cap. 13+13 pcs - 2/3 gr approx
123x4 - 109x5 mm

CHOCOFUNNY MOULDS

Lo stampo, realizzato in resistente materiale plastico RIUTILIZZABILE, è composto da due placche trasparenti, una che riporta l'incisione del soggetto nella quale stendere il burro di cacao colorato, e l'altra da posizionare sopra, nella quale inserire lo stecco in plastica (in caso di stampo lollipop) e versare il cioccolato. Disponibili espositori da banco per la vendita.

Our moulds, made of reusable durable plastic, are made of two transparent plates: one showing the engraving of a subject in which you lay your coloured cocoa butter, and the other one, to be placed above, in which you put the plastic stick (for lollipop moulds) and pour the chocolate. Display for sale available. Misura - Size: 175x275mm





Cod. 20-C014
Cuori misti
Mix Heart
44x39 mm circa - 4x3 pcs



Cod. 20-C001
Coniglio con carota
Bunny with carrot
49x45 mm - 11 pcs



Cod. 20-C002
Gallo
Rooster
55x60 mm - 10 pcs



Cod. 20-C003
Uova
Egg
39x50 mm - 11 pcs



Cod. 20-C004
Uova
Egg
35x45 mm - 14 pcs



Cod. 20-C005
Coniglio
Bunny
45x59 mm - 8 pcs



Cod. 20-C006
Pulcino
Chick
42x62 mm - 8 pcs



Cod. 20-C007
Ape
Bee
47x46 mm - 12 pcs



Cod. 20-C008
Sole
Sun
Ø48 mm - 11 pcs



Cod. 20-C009
Farfalla
Butterfly
34x46 mm - 12 pcs



Cod. 20-C010
Farfalla
Butterfly
56x45 mm - 8 pcs



Cod. 20-C011
Farfalla
Butterfly
33x54 mm - 12 pcs



Cod. 20-C012
Ape
Bee
39x46 mm - 11 pcs



Cod. 20-C013
Fiore
Flower
45x41 mm - 12 pcs



Cod. 20-C015
Cuore
Heart
42x39 mm - 12 pcs



Cod. 20-C016
Cuore
Heart
43x40 mm - 12 pcs



Cod. 20-C018
9 pcs
LETTERE - LETTERS:
ABCDEFGHI
42x40 mm approx
2/4 gr approx.



Cod. 20-C019
9 pcs
LETTERE - LETTERS:
JKLMNOPQR
42x40 mm approx
2/4 gr approx.



Cod. 20-C020
8 pcs
LETTERE - LETTERS:
STUVWXYZ
42x40 mm approx
2/4 gr approx.



Cod. 20-C021
5 pcs
NUMERI GRANDI
BIG NUMBERS:
01234
74x62 mm approx
12/14 gr approx.



Cod. 20-C022
5 pcs
NUMERI GRANDI
BIG NUMBERS:
56789
74x62 mm approx
12/14 gr approx.



Cod. 20-C023
10 pcs
NUMERI PICCOLI
SMALL NUMBERS:
0123456789
41x50 mm approx
4/6 gr approx.

HOW TO USE

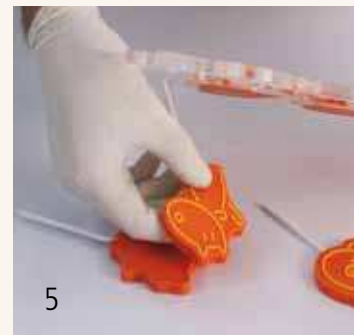
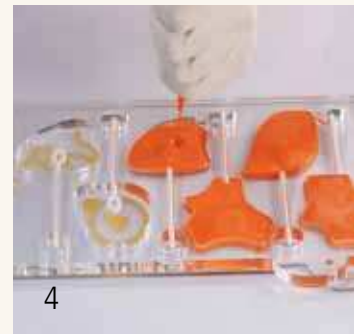

1 - Stendere il burro di cacao o del cioccolato colorato temperato sulla placca incisa ChocoFunny;
 2 - Lasciar cristallizzare il cioccolato e successivamente pulire con un panno le eventuali sbavature.
 3 - Posizionare sopra alla placca con l'incisione la placca forata, fissandola con i due perni. Inserire lo stecco all'interno della guida preposta.

4 - Con l'aiuto di una sac a poche riempire la sagoma con il cioccolato;
 Lasciar cristallizzare il cioccolato prima di staccare i soggetti dalla placca.

5 - Per la sformatura fare una leggera pressione con i pollici e se necessario staccare i soggetti delicatamente anche dalla placca sagomata.

1 - Spread tempered cocoa butter or coloured chocolate on the engraved ChocoFunny plate using a rubber spatula;

2 - Let the chocolate crystallize and then wipe off with a cloth any excess of chocolate

3 - Place the pierced plate over that with the engraving fixing it with two pins and insert the stick inside the rail.

4 - Fill the subject with the chocolate by using a pastry bag;

Let the chocolate crystallize before removing the subject from the plate.

5 - Make a slight pressure with your thumbs to take the subjects out of the mould and, if necessary, gently remove them even from the shaped plate.



Cod. **20-C017**

Cap.6 pcs
 60x70 mm
 30gr approx



Cod. **20-C024**

Cap.6 pcs
 60x70 mm
 30gr approx



Bastoncini per lollipops
Sticks for lollipops



cod. **20-B002** 105 mm 100 pcs
cod. **20-B001** 105 mm 400 pcs

Sacchetti per lollipops
Bags for lollipops



cod. **20-S002** 80x120 mm 100 pcs
cod. **20-S001** 80x120 mm 400 pcs
cod. **20-S003** 90x130 mm 100 pcs

Bastoncini per cake pops
Sticks for cake pops



cod. **20-B003** 128x15mm 400 pcs

Espositori per lollipops
Displays for lollipops



Cod. **EL201**
Cap.66 pcs
450x240 h145 mm



Cod. **EL101**
Cap.56 pcs
345x280 h40 mm



Cod. **EL309**
Cap.30 pcs
295x70 h125 mm



Cod. **EL203**
Arancione - Orange
Cap.19 pcs
140x175 h370 mm

Cod. **EL209**
Fucsia - Fuchsia
Cap.19 pcs
140x175 h370 mm

LOLLIPOP MOULDS





Cod. 20L001

Cap. 8 pcs
Misura - Size: 52x77 h9 mm
30 gr approx
Pack 2 stampi - moulds
Stampi - Moulds: 200x300 mm



Cod. 20L002

Cap. 8 pcs
Misura - Size: Ø60 h9 mm
30 gr approx
Pack 2 stampi - moulds
Stampi - Moulds: 200x300 mm



Cod. 20L003

Cap. 8 pcs
Misura - Size: 50x75 h9 mm
30 gr approx
Pack 2 stampi - moulds
Stampi - Moulds: 200x300 mm



MESSAGES MOULDS

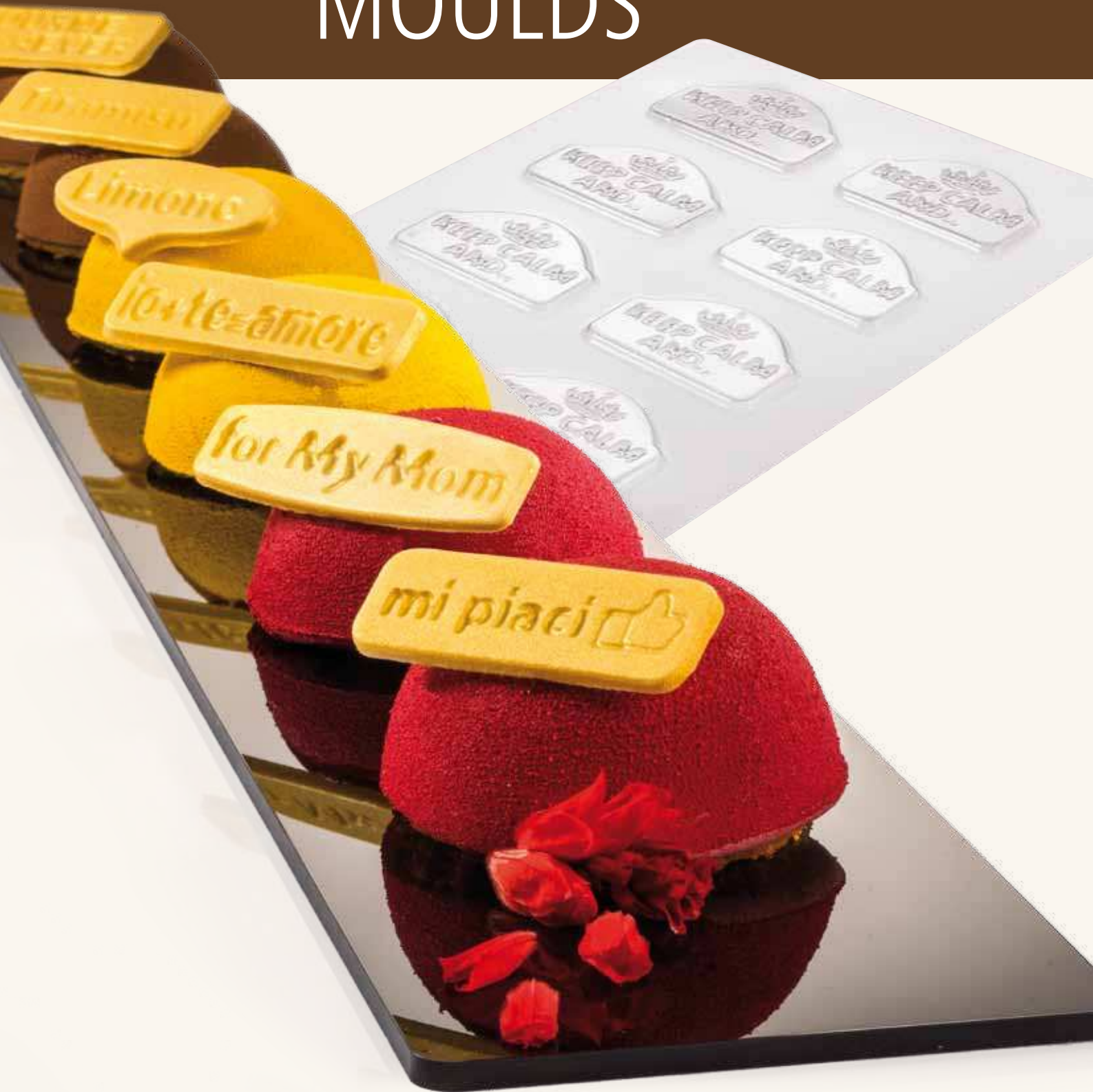

io+te=amore

Cod. **23001**

misura size: 67x18 h2mm

12 pcs



mi piaci

Cod. **23002**

misura size: 57x20 h2mm

12 pcs



punta in alto

Cod. **23003**

misura size: 69x17 h2mm

12 pcs



keep calm and...

Cod. **23004**
misura size: 60x38 h2mm
8 pcs



sacher

Cod. **23005**
misura size: 61x25 h2mm
12 pcs



for my mom

Cod. **23006**
misura size: 70x21 h2mm
12 pcs



you & me 4ever

Cod. **23007**
misura size: 61x23 h2mm
12 pcs



just married

Cod. **23008**
misura size: 87x32 h2mm
8 pcs



I ♥ you

Cod. **23009**
misura size: 62x37 h2mm
10 pcs



auguri frizzanti

Cod. **23010**
misura size: 54x23 h2mm
12 pcs



tiramisù

Cod. **23011**
misura size: 61x21 h2mm
12 pcs



limone

Cod. **23012**
misura size: 62x33 h2mm
12 pcs



Easter

Cod. **23013**
misura size: 60x33 h2mm
10 pcs



mimosa

Cod. **23014**
misura size: 69x29 h2mm
12 pcs



nocciola

Cod. **23015**
misura size: 62x22 h2mm
12 pcs



pistacchio

Cod. **23016**
misura size: 79x25 h2mm
12 pcs



caffè

Cod. **23017**
misura size: 50x30 h2mm
12 pcs



caprese

Cod. **23018**
misura size: 63x25 h2mm
12 pcs



Chocolate

Cod. **23019**
misura size: 75x23 h2mm
12 pcs



Chantilly

Cod. **23020**
misura size: 74x32 h2mm
12 pcs



Yogurt

Cod. **23021**
misura size: 61x30 h2mm
12 pcs



for My Dad

Cod. **23022**
misura size: 70x21 h2mm
12 pcs



Auguri

Cod. **23023**
misura size: 59x29 h2mm
12 pcs



Happy Birthday

Cod. **23024**
misura size: 68x37 h2mm
10 pcs

POLYCARBONATE 3D MOULDS

Con gli stampi 3D è possibile creare soggetti dalle forme più fantasiose. Idee originali per allietare il banco pasticceria e le vetrine in vista delle varie festività.

3D moulds allow you to make chocolate figures with the most fanciful shapes. An original way to brighten up the pastry shop counter or windows for the various holidays.

Stampo - Mould: 275x175 mm



HOW TO USE

- 1 - Riempire mezzo guscio utilizzando una sac a pochés.
- 2 - Chiudere avendo cura di posizionare correttamente l'altra metà dello stampo.
- 3 - Far ruotare ripetutamente lo stampo affinché il cioccolato aderisca alle pareti in modo uniforme.
- 4 - Sformare il soggetto avendo cura di aprire i due gusci con delicatezza.

- 1 - Close the mould paying attention to combine correctly the two halves.
- 2 - Fill one half of the mould using a pastry bag.
- 3 - Rotate the mould (in all directions) for some time, so that the chocolate spreads all over the internal surface.
- 4 - Remove gently the two halves of the mould.

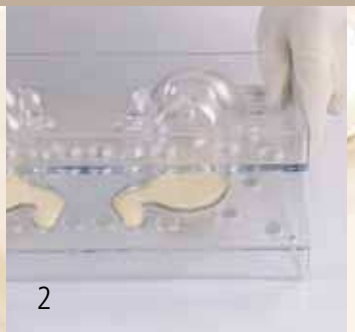



Cod. **20-C1009**

Cap. 4+4 pcs

Misura Albero / Tree size: 53x45 h71 mm

Misura Candela / Candle size: Ø49 h76 mm



Cod. **20-C1010**

Cap. 4+4 pcs

Misura Babbo Natale / Santa Claus size: Ø46 h79 mm

Misura Pupazzo di Neve / Snowman size: 42x46 h72 mm



Cod. **20-C1011**

Cap. 2+2 pcs

Misura - size Black Cat: 57x40 h102 mm

Misura - size Mr. Pumpkin: 38x40 h96 mm



Cod. **SCC01**

Misura / size: 25x95 mm



Per visualizzare imballi ed espositori disponibili vedi da pg 128 a pg 133
To see available packaging and displays see from page 128 to page 133

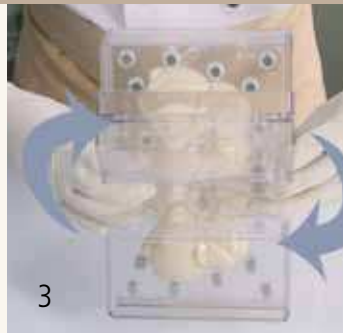



Cod. 20-C1003

Cap. 2 pcs
Scoiattolo Papà - Dad Squirrel
92x51 h120 mm
118 gr approx



Cod. 20-C1004

Cap. 4 pcs
Scoiattolo Mamma - Mum Squirrel
103x40 h80 mm
55 gr approx

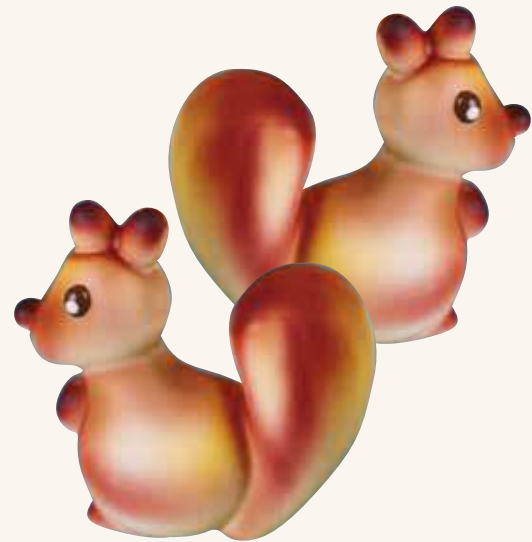

Cod. 20-C1005

Cap. 6 pcs
Scoiattolo Bebè - Baby Squirrel
68x32 h64 mm
32 gr approx



Cod. 20-C1001

Cap. 4 pcs
Renna - Reindeer
43x43 h120 mm
65 gr approx



Cod. 20-C1002

Cap. 4 pcs
Renna - Reindeer
46x45 h100 mm
68 gr approx



Cod. 20-C1000

Cap. 5 pcs
Albero - Tree
Ø58 h 100 mm
100 gr approx

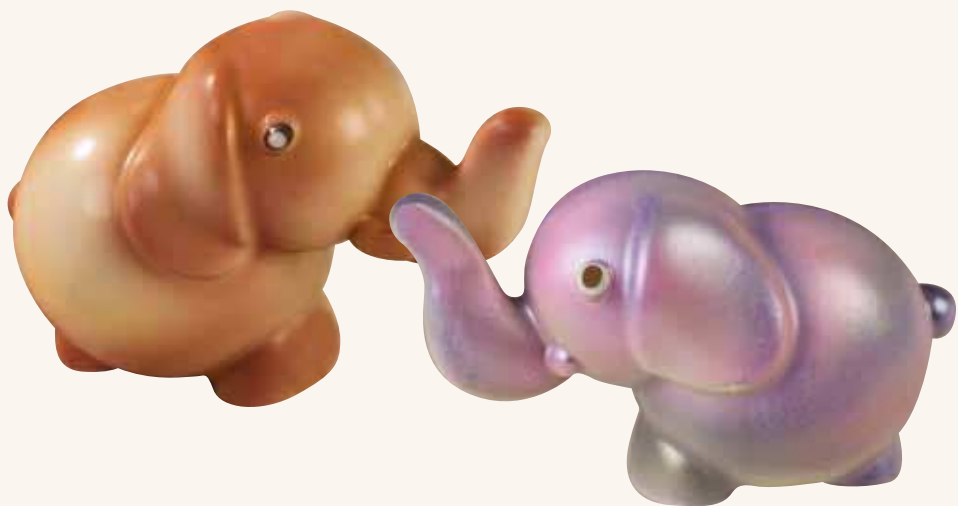

Cod. 20-C1006

Cap.2 pcs
 Elefante Papà - Dad Elephant
 123x64 h81 mm
 128 gr approx

Cod. 20-C1007

Cap.4 pcs
 Elefante Mamma - Mum Elephant
 113x62 h62 mm
 87 gr approx



Cod. 20-C1008

Cap.6 pcs
 Elefante Bebè - Baby Elephant
 81x43 h53 mm
 36 gr approx



Cod. 20-C1955

Cap.2 pcs
 Gallo - Rooster
 100x160 h126 mm
 115 gr approx



Cod. 20-C1956

Cap.4 pcs
 Gallina - Hen
 94x108 h106 mm
 75 gr approx



Cod. 20-C1957

Cap.6 pcs
 Pulcino - Chick
 65x84 h80 mm
 45 gr approx

Cod. MA1956*

Cap.4 pcs
 Gallina - Hen
 94x108 h106 mm
 *Stampi mezzo guscio - Half shell moulds

Cod. MA1957*

Cap.6 pcs
 Pulcino - Chick
 65x84 h80 mm
 *Stampi mezzo guscio - Half shell moulds

PLASTIC HOLLOW 3D MOULDS

Stampi in plastica corpo cavo per soggetti di cioccolato pasquali, disponibili varie forme e dimensioni.

Plastic moulds, hollow forms for Easter chocolate subjects, different shapes and sizes available.



Easter



cod. **MAC611S** 70x70 h120 1 figure



Big

cod. **MAC602S** 160x120 h210 1 figure
Kit 3 pcs



Big

cod. **MAC603S** 140x120 h 190 1 figure
Kit 3 pcs



Big

cod. **MAC604S** 120x120 h220 1 figure
Kit 3 pcs



cod. **MAC612S** 70x70 h130 1 figure



cod. **MAC613S** Ø80 h 120 1 figure



cod. **MAC614S** Ø60 h 140 1 figure



cod. **MAC600** h200 1 figure



cod. **MAC601** h200 1 figure



cod. **MAC610S** h170 1 figure



cod. **MAC620S** h180 1 figure



cod. **MAC630S** h235 1 figure



cod. **MAC640** h185 1 figure



cod. **MAC650** h145 1 figure



cod. **MAC660** h110 1 figure
 cod. **MAC661S** h140 1 figure
 cod. **MAC662** h190 1 figure



cod. **MAC670S** h195 1 figure



cod. **MAC683** h130 4 figures
cod. **MAC686** h275 1 figure
cod. **MAC687** h360 1 figure



cod. **MAC690** h215 1 figure
cod. **MAC691** h320 1 figure



cod. **MAC710** h225 1 figure



cod. **MAC720S** h170 2 figures
MAC721 h220 1 figure
MAC722 h360 1 figure



cod. **MAC740** h220 1 figure



cod. **MAC750** h110 3 figures



cod. **MAC760S** h150 1 figure



cod. **MAC770** h110 3 figures



cod. **MAC800S** h160 2 figures
 cod. **MAC801S** h205 1 figure
 cod. **MAC802** h65 3 figures



cod. **MAC810** h60 3 figures



cod. **MAC820** h55 4 figures
 cod. **MAC821** h85 4 figures
 cod. **MAC822S** h110 1 figure
 cod. **MAC823S** h160 1 figure
 cod. **MAC824** h200 1 figure



cod. **MAC832** h175 1 figure



cod. **MAC840** h170 1 figure
 cod. **MAC841** h265 1 figure



cod. **MAC870S** h110 3 figures



cod. **MAC850S** h125 2 figures



cod. **MAC860S** h125 2 figures



cod. **MAC880S** h145 1 figure



cod. **MAC920S** h97 2 figures



cod. **MAC950S** h110 1 figure
 cod. **MAC951** h115 1 figure
 cod. **MAC952S** h140 1 figure
 cod. **MAC953** h150 1 figure
 cod. **MAC954** h190 1 figure



cod. **MAC900** h110 1 figure
 cod. **MAC901** h175 1 figure



cod. **MAC910** h40 1 figure
 cod. **MAC913** h55 1 figure



Big

cod. **MAC730** h480 1 figure

Christmas



cod. **MAC403S** 90x80 h120 1 figure



cod. **MAC404S** Ø82 h128 1 figure



cod. **MAC402S** 64x70 h110 1 figure



cod. **MAC401S** Ø70 h120 1 figure



cod. **MAC170S** h168 1 figure



cod. **MAC240S** h185 1 figure



cod. **MAC281S** h180 1 figure



cod. **MAC320S** h114
cod. **MAC321S** h150 3 figures
1 figure



cod. **MAC110** h204 1 figure



cod. **MAC120** h110 4 figures
cod. **MAC122S** h140 4 figures
cod. **MAC123** h190 2 figures
cod. **MAC125** h320 1 figure



cod. **MAC130S** h122 3 figures
cod. **MAC131** h157 2 figures



cod. **MAC140S** h180 1 figure



cod. **MAC150** h140 1 figure
cod. **MAC151** h220 1 figure



cod. **MAC161** h110 3 figures
cod. **MAC162** h140 1 figure
cod. **MAC163** h220 1 figure
cod. **MAC164** h310 1 figure



cod. **MAC180** h145 1 figure



cod. **MAC190S** h170 1 figure



cod. **MAC200S** h120 1 figure



cod. **MAC230** h95 1 figure



cod. **MAC260** h95 4 figures
cod. **MAC261** h245 1 figure



cod. **MAC270** h140 1 figure
cod. **MAC271** h200 1 figure



cod. **MAC300** h230 1 figure



cod. **MAC310S** h100 2 figures



cod. **MAC311** h165 1 figure



cod. **MAC421S** h135 1 model
cod. **MAC420** h125 1 model



cod. **MAC440** h150 1 model
cod. **MAC441** h205 1 model



cod. **MAC000** h80 3 figures
 cod. **MAC001S** h125 2 figures
 cod. **MAC002S** h175 1 figure



cod. **MAC020** h95 3 figures



cod. **MAC410S** h192 1 figure



cod. **MAC500** h110 3 figures
 cod. **MAC501** h140 2 figures
 cod. **MAC502** h170 2 figures
 cod. **MAC503** h240 1 figure
 cod. **MAC504** h320 1 figure



cod. **MAC510** h110 3 figures
 cod. **MAC511** h140 2 figures
 cod. **MAC513** h235 1 figure



cod. **MAC521** h180 1 figure
 cod. **MAC522** h220 1 figure
 cod. **MAC523** h255 1 figure



Big

cod. **MAC220** h475 1 figure



Big

cod. **MAC400** h415 1 model

Halloween



cod. **MAC406S** 95x90 h110 1 figure



cod. **MAC405S** 78x56 h140 1 figure



cod. **MAC324S** 52x54 h132 1 figure



cod. **MAC325S** 140x140 h150 1 figure

Shoes



cod. **MAC329S** 95x35 h75 1 figure



cod. **MAC328S** 100x40 h 60 1 figure



cod. **MAC327S** 90x40 h35 1 figure



cod. **MAC326S** 220x75 h170 1 figure



cod. **MAC323S** Ø120 1 figure



cod. **MAC322S** 195x60 h80 1 figure

FLOREAL DECORATION MOULDS

La qualità del policarbonato utilizzato per la produzione degli stampi Martellato, garantisce un'ottimale produzione di soggetti e praline di cioccolato dall'indubbia lucentezza ed eleganza.

The quality of the polycarbonate used to produce Martellato moulds assures the best production of bright and elegant shapes and chocolate pralines. Stampo - Mould: 275x175 mm



Cod. **MA3001**
Cap. 6 pcs - 8 gr approx
39x104 mm

Cod. **MA3004**
Cap. 6 pcs - 8 gr approx
72x71 mm

Cod. **MA3000**
Cap. 6 pcs - 8 gr approx
40x106 mm



Cod. **MA3002**
Cap. 6 pcs - 8 gr approx
56x83 mm



Cod. **MA3003**
Cap. 6 pcs - 8 gr approx
70x57 mm



EGGS MOULDS



Stampo mezzo guscio in plastica rigida (PETG).
Half shell mould made of strong plastic material (PETG).

cod. SUT25X17	250x170 mm	kg 0,5 - 1
cod. SUT28X18	280x185 mm	kg 0,8 - 1,2
cod. SUT34X25	325x240 mm	kg 1,5 - 2
cod. SUT40X27	390x265 mm	kg 2 - 2,5
cod. SUT45X32	435x310 mm	kg 2,5 - 3,5
cod. SUT54X36	520x350 mm	kg 4 - 6
cod. SUT64X43	620x420 mm	kg 6 - 8
cod. SUT75X50	740x490 mm	kg 8 - 10



Vedi pagina 61 i supporti per uova.
See page 61 Eggs holders.

Stampi uova sezionate Sectioned eggs moulds



Cod. **20-U1010**

h110 mm
100 gr approx

Uovo sezionato piccolo composto da 4 sezioni.
Sectioned small egg consists of four sections.



Cod. **20-U1011**

h180 mm
250 gr approx

Uovo sezionato grande composto da 5 sezioni.
Sectioned large egg consists of five sections.



HOW TO USE



EGGS MOULDS

Stampi MEZZO GUSCIO HALF EGG moulds

Cod. **20U032**

32,5X22,5 mm
10gr
prod. 32 mezzi/half

Stampo - Mould:
175X275 h 24 mm

Ganci (non inclusi)
Hooks (not included):
20UG01



Cod. **20UG01**

gancio - hook 24 mm
pack 4 pcs



Cod. **20U065**

65x45 mm
20gr
prod. 16 mezzi/half

Stampo - Mould:
200x365 h 22 mm

Ganci (non inclusi)
Hooks (not included):
20UG02

Cod. **20U100**

100x150 mm
130 gr
prod. 3 mezzi/half

Stampo - Mould:
295x365 h 22 mm

Ganci (non inclusi)
Hooks (not included):
20UG02

Cod. **20U170**

170x108 mm
175-200gr
prod. 3 mezzi/half

Stampo - Mould:
200x365 h 22 mm

Ganci (non inclusi)
Hooks (not included):
20UG02

Cod. **20U205**

205x135 mm
250gr
prod. 2 mezzi/half

Stampo - Mould:
200x365 h 22 mm

Ganci (non inclusi)
Hooks (not included):
20UG02

Cod. **20U230**

230x163 mm
350gr
prod. 1 mezzi/half

Stampo - Mould:
200x365 h 22 mm

Ganci (non inclusi)
Hooks (not included):
20UG02

Cod. **20U258**

258x175 mm
500gr
prod. 1 mezzi/half

Stampo - Mould:
200x365 h 22 mm

Ganci (non inclusi)
Hooks (not included):
20UG02

Cod. **20U320**

320x210 mm
850 gr
prod. 1 mezzi/half

Stampo - Mould:
275x365 h 22 mm

Ganci (non inclusi)
Hooks (not included):
20UG02



Cod. **20UG02**

gancio - hook 22 mm
pack 4 pcs



Stampi UOVA con magneti per macchina rotativa EGG moulds with magnets for rotating machine

Cod. **20U032A**
32,5X22,5 mm
10gr
prod. 32 pcs

Cod. **20U065A**
65X45 mm
20gr
prod. 16 pcs

Cod. **20U100A**
100x150 mm
130 gr
prod. 3 pezzi/half

Stampo - Mould:
175X275 mm

Stampo - Mould:
200x365 mm

Stampo - Mould:
295x365 mm

Cod. **20U170A**
170X108 mm
175-200gr
prod. 3 pcs

Cod. **20U205A**
205X135 mm
250gr
prod. 2 pcs

Cod. **20U230A**
230X163 mm
350gr
prod. 1 pc

Stampo - Mould:
200x365 mm

Stampo - Mould:
200x365 mm

Stampo - Mould:
200x365 mm

Cod. **20U258A**
258X175 mm
500gr
prod. 1 pc

Cod. **20U320A**
320X210 mm
850 gr
prod. 1 pc

Stampo - Mould:
200x365 mm

Stampo - Mould:
275x365 mm

Vasetto in plastica porta uovo Plastic egg holders



cod. **21VA085**
Ø85 h70 mm
Conf. 58 pcs

cod. **21VA102**
Ø102 h88 mm
Conf. 40 pcs

Stampi cioccolato per supporto uova di Pasqua Chocolate moulds for Easter eggs holder



cod. **20-CU001**
Set 3 pcs

36,5x36,5 h9 mm
12 pcs

40,5x40,5 h12 mm
9 pcs

52,7x52,7 h12 mm
6 pcs



MASK MOULDS

Con gli stampi maschere cioccolato è possibile realizzare in modo facile e veloce dei soggetti eleganti e tradizionali che evocano l'atmosfera criptica del teatro o il giocoso mondo del carnevale veneziano. Disponibili in varie forme e dimensioni, gli stampi sono realizzati in materiale plastico idoneo al contatto con gli alimenti.

Un'idea suggestiva per decorare la vetrina della pasticceria, con uno strumento di facile utilizzo e che permette di ottenere ottimi risultati in poco tempo.

With the chocolate masks moulds you can easily and quickly make elegant and traditional figures that bring to mind a cryptic theatre atmosphere or the playful world of Venetian carnival.

Available in various sizes and shapes, the moulds are made of food-safe plastic. A charming way to decorate the window of a pastry shop with an easy-to-use tool which allows you to achieve excellent results in no time.



cod. **CARNEVAL1**
205x142x48 mm
195x142x60 mm
164x142x55 mm

cod. **CARNEVAL2**
160x120x48 mm
140x132x40 mm
137x142x45 mm
115x88x25 mm



cod. **20-CA001**
125x175x40 mm - prod. 1 pc



cod. **20-CA002**
135x175x40 mm - prod. 1 pc



cod. **20-CA003**
155x190x40 mm - prod. 1 pc



cod. **20-CA004**
130x130x60 mm - prod. 1 pc



cod. **20-CA005**
135x160x45 mm - prod. 1 pc



cod. **20-CA006**
130x180x60 mm - prod. 1 pc



cod. **20-CA007**
85x85x45 mm - prod. 1 pc
80x90x70 mm - prod. 1 pc



cod. **20-CA008**
130x105x35 mm - prod. 1 pc



cod. **20-CA009**
105x135x40 mm - prod. 1 pc



cod. **20-CA010**
30x45x15 mm - prod. 9 pcs



cod. **20-CA011**
50x65x20 mm - prod. 5 pcs



cod. **20-CA012**
60x85x35 mm - prod. 2 pcs
65x90x30 mm - prod. 2 pcs

OTHER MOULDS

Kit composto da:
1 stampo semisfera e 4 stampi petalo.
Kit made up of
1 hemisphere mould and 4 petal moulds.



Cod. **20-1010**
Cap. 6 petals
105x50 h 25 mm



Cod. **20-1011**
Cap. 8 petals
80x35 h 18 mm

Stampi sfera in PETG
Made of PETG sphere moulds



Cod. **MACS001**
Ø300 - Ø245 mm



Cod. **MACS002**
Ø200 - Ø175 - Ø150 - Ø140 - Ø130 - Ø100mm



Cod. **MACS003**
4x Ø90 - 4x Ø75 - 4x Ø65 - 6x Ø50 mm

Stampi in plastica per tavolette di cioccolato
Plastic moulds for chocolate bars



Cod. **TC001/5**
 150x70 mm
 Pack 5 pcs



Cod. **TC002/5**
 150x70 mm
 Pack 5 pcs



Cod. **TC003/5**
 150x70 mm
 Pack 5 pcs



Decorazione per Cupcake Pallone da Calcio
Cupcake Decorations Soccer Ball

Cod. **20-CA100**
 Ø65 h 23 mm



Stampi in plastica per cornici di cioccolato.
Plastic moulds for chocolate frames.

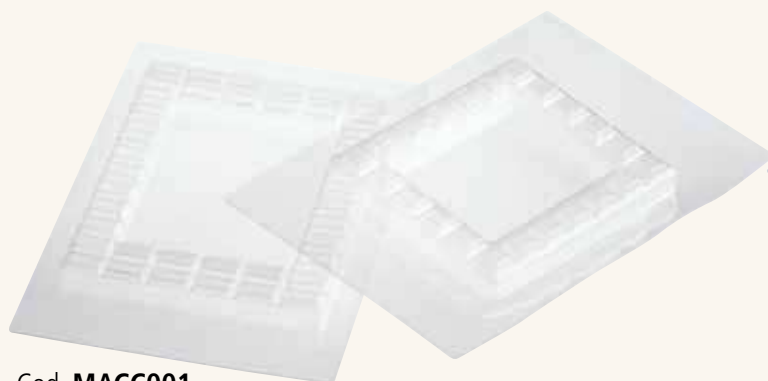



Cod. **MACC001**
 175x145 h20 mm
 215x165 h20 mm



Cod. **MACC002**
 230x185 h15 mm
 230x185 h15 mm

POLYETHYLENE MOULDS

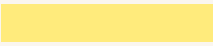
Legenda - vedi listino prezzi
Legend - see price list

-  Stampi piccoli
Small moulds
-  Stampi standard
Standard moulds
-  Stampi grandi
Big moulds

Lo stampo in polietilene è sufficientemente flessibile per permettere una facile sformatura del soggetto di cioccolato, ma allo stesso tempo la plastica ha uno spessore tale da garantire molti usi senza il rischio di rottura.

Stampi in polietilene per realizzare praline. Moltissimi soggetti per tutte le occasioni.

The polyethylene mould is flexible enough to make removal easy and at the same time plastic has a thickness that guarantees a long lasting usage.

Polyethylene moulds for the production of pralines. Many subjects for every occasion.

Valentine Day

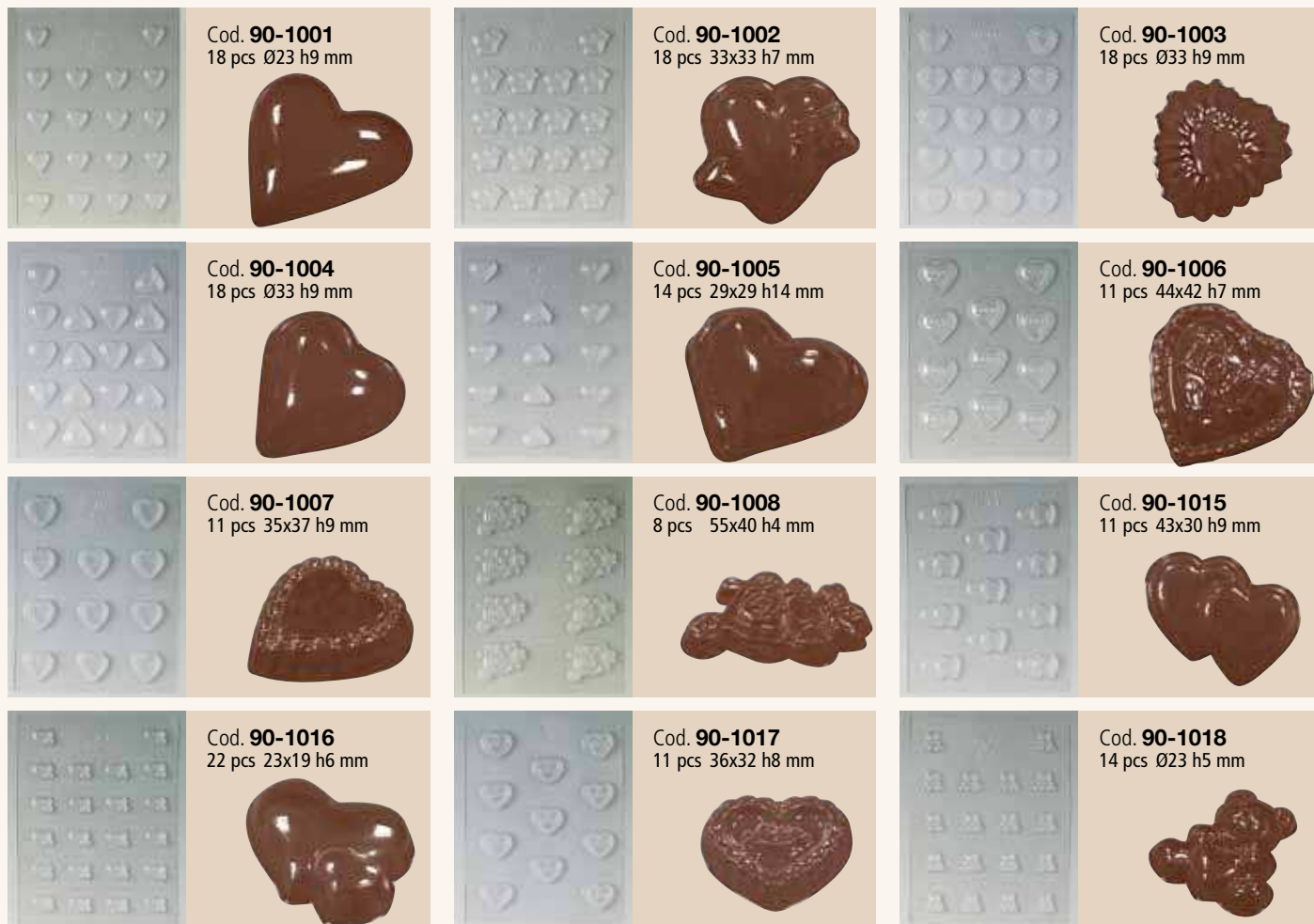



Cod. **90-1019**
11 pcs 40x37 h7 mm



Cod. **90-1021**
11 pcs 44x32 h7 mm



Cod. **90-1023**
18 pcs 25x23 h7 mm



Cod. **90-1024**
14 pcs Ø27 h7 mm



Cod. **90-1025**
12 pcs 42x38 h10 mm



Cod. **90-1026**
8 pcs 52x42 h12 mm



Cod. **90-1027**
14 pcs 32x27 h6 mm



Cod. **90-1028**
11 pcs 42x38 h8 mm



Cod. **90-1029**
11 pcs 34x34 h13 mm



Cod. **90-1044**
11 pcs 45x35 h18 mm



Cod. **90-1046**
15 pcs Ø23 h17 mm



Cod. **90-1202**
6 pcs 145x50 h12 mm



Cod. **90-1204**
3 pcs 145x40 h20 mm 3 pcs 145x40 h20 mm



Cod. **90-1212**
3 pcs 152x78 h8 mm

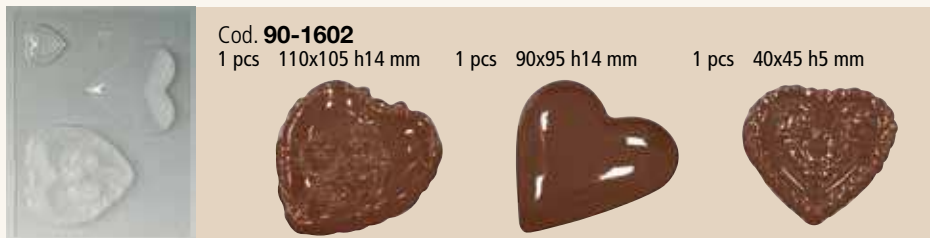

Cod. **90-1602**
1 pcs 110x105 h14 mm 1 pcs 90x95 h14 mm 1 pcs 40x45 h5 mm



Cod. **90-1608**
3 pcs 80x77 h12 mm



Cod. **90-1609**
1 pcs 150x145 h12 mm 6 pcs 26x30 h10 mm



Cod. **90-15507**
5 pcs 57x35 h8 mm 4 pcs 57x35 h8 mm



Cod. **90-1612**
1 pcs 155x160 h32 mm



Cod. **90-1613**
2 pcs 105x100 h10 mm



Cod. **90-1627**
1 pcs 128x125 h22 mm

Easter



Stampi cioccolato per supporto uova di Pasqua
Chocolate moulds for Easter eggs holder

36,5x36,5 h9 mm
 12 pcs

40,5x40,5 h12 mm
 9 pcs

52,7x52,7 h12 mm
 6 pcs

cod. 20-CU001
 Set 3 pcs



Cod. 90-2008
 18 pcs 36x23 h12 mm



Cod. 90-2009
 14 pcs 39x25 h13 mm



Cod. 90-2010
 14 pcs 40x31 h17 mm



Cod. 90-2014
 12 pcs 37x48 h6 mm



Cod. 90-2016
 11 pcs 37x33 h10 mm



Cod. 90-2020
 8 pcs 65x41 h14 mm



Cod. **90-2021**
8 pcs 65x41 h14 mm



Cod. **90-2025**
11 pcs 42x30 h14 mm



Cod. **90-2026**
18 pcs 25x35 h12 mm



Cod. **90-2254**
2 pcs 150x75 h28 mm



Cod. **90-2030**
8 pcs 36x45 h20 mm



Cod. **90-2033**
14 pcs 34x27 h10 mm



Cod. **90-2034**
9 pcs 30x32 h6 mm 9 pcs 30x32 h6 mm



Cod. **90-2035**
18 pcs 35x27 h10 mm



Cod. **90-2102**
3 pcs 43x40 h12 mm 4 pcs 40x35 h11 mm 4 pcs 40x35 h17 mm 3 pcs 48x35 h8 mm

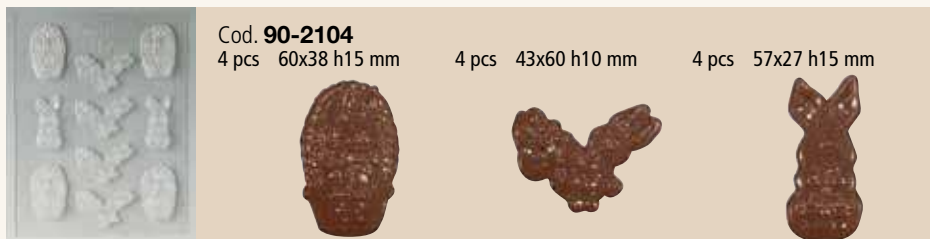

Cod. **90-2104**
4 pcs 60x38 h15 mm 4 pcs 43x60 h10 mm 4 pcs 57x27 h15 mm



Cod. **90-2114**
4 pcs 40x22 h10 mm 4 pcs 35x30 h10 mm 4 pcs 36x36 h10 mm 4 pcs 36x24 h10 mm

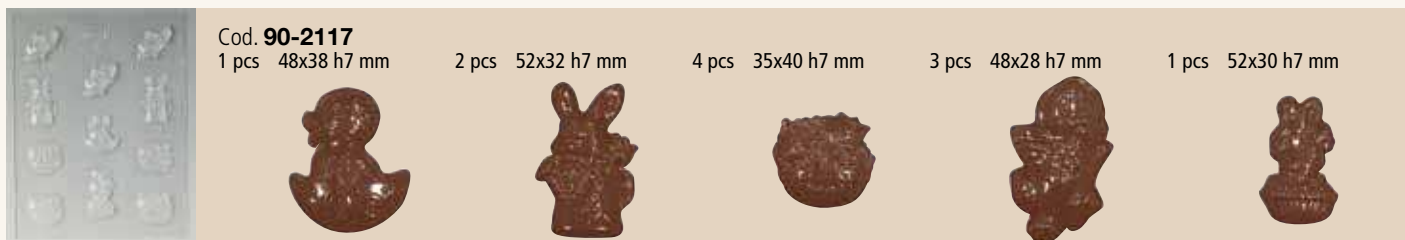

Cod. **90-2117**
1 pcs 48x38 h7 mm 2 pcs 52x32 h7 mm 4 pcs 35x40 h7 mm 3 pcs 48x28 h7 mm 1 pcs 52x30 h7 mm



Cod. **90-2118**
3 pcs 90x35 h7mm 3 pcs 70x28 h7mm 1 pcs 45x28 h7mm 3 pcs 52x22 h7mm 3 pcs 45x25 h7mm 2 pcs 30x10 h7mm



Cod. **90-2119**

10 pcs 22x14 h6 mm

10 pcs 20x15 h6 mm

10 pcs 28x15 h6 mm

10 pcs 20x23 h6 mm



Cod. **90-2121**

2 pcs 27x32 h7 mm 2 pcs 35x35 h7 mm 2 pcs 32x30 h7 mm 2 pcs 35x20 h7 mm 2 pcs 40x30 h7 mm 2 pcs 25x32 h7 mm



Cod. **90-2302**

3 pcs 60x50 h26 mm

3 pcs 60x50 h26 mm



Cod. **90-2305**

1 pcs 112x95 h20 mm

1 pcs 112x95 h20 mm



Cod. **90-2314**

1 pcs 170x60 h34 mm

1 pcs 170x60 h34 mm



Cod. **90-2316**

2 pcs 79x58 h12 mm

2 pcs 79x58 h12 mm



Cod. **90-2318**

2 pcs 79x58 h13 mm

2 pcs 79x58 h13 mm



Cod. **90-2320**

3 pcs 60x65 h15 mm

3 pcs 60x65 h15 mm



Cod. **90-2330**

3 pcs 54x54 h16 mm

3 pcs 54x54 h16 mm



Cod. **90-2333**

1 pcs 150x78 h40 mm

1 pcs 150x78 h40 mm



Cod. **90-2346**

1 pcs 150x64 h25 mm

1 pcs 150x64 h25 mm



Cod. **90-2339**

1 pcs 150x90 h21 mm

1 pcs 150x90 h21 mm



Cod. **90-2342**

1 pcs 74x122 h18mm

1 pcs 74x122 h18mm



Cod. **90-2345**

1 pcs 105x86 h26mm

1 pcs 105x86 h26mm



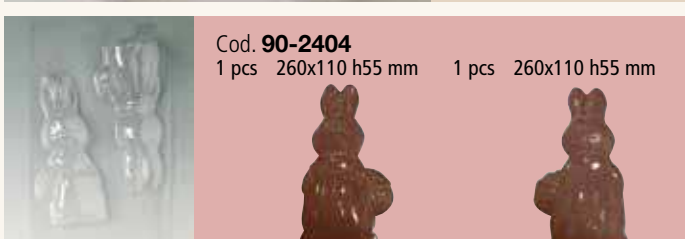
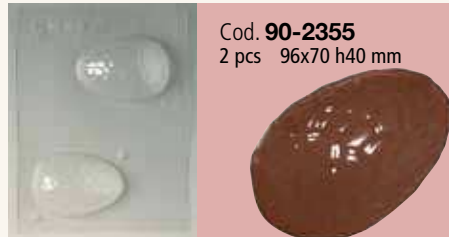

Kit composto da 3 diverse scenette.
Kit made up of 3 different landscapes.

Cod. **20-S2010**

Kit stampi in plastica composto da 3 diverse scenette di Pasqua.

L'altezza del soggetto finito è di circa 110 mm.

3 plastic kits made up of 3 different chocolate landscapes.

The finished shapes is 110 mm high.

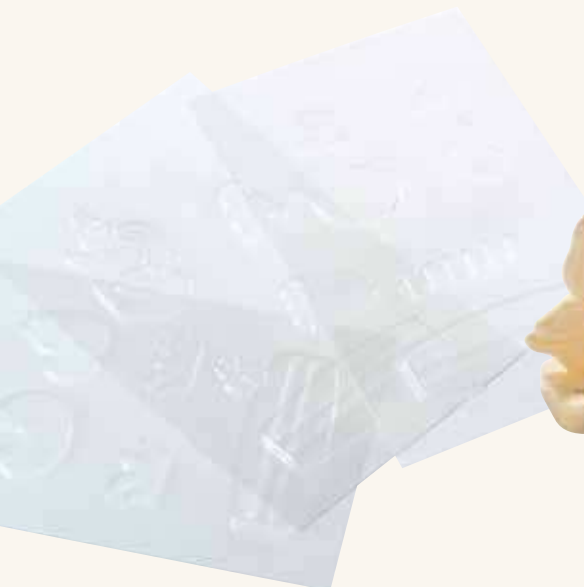

Kit composto da 3 diverse scenette.
Kit made up of 3 different landscapes.

Cod. **20-S1010**

Kit stampi in plastica composto da 3 diverse scenette di Natale.

L'altezza del soggetto finito è di circa 110 mm.

3 plastic kits made up of 3 different chocolate landscapes.

The finished shapes is 110 mm high.



Halloween



Cod. **90-3212**
4 pcs 60x60 h10 mm



Cod. **90-3273**
1 pcs 210x70 h13 mm 2 pcs 180x70 h13 mm



Cod. **90-3301**
1 pcs 110x95 h45 mm 1 pcs 110x95 h45 mm



Cod. **90-3216**
4 pcs 70x90 h10 mm



Christmas



Cod. **90-4010**
11 pcs 50x27 h4 mm



Cod. **90-4013**
8 pcs 40x60 h10mm



Cod. **90-4102**
1 pcs 60x45 h10mm 1 pcs 50x40 h10mm



Cod. **90-4016**
8 pcs 45x45 h14mm



Cod. **90-4017**
11 pcs 45x40 h8mm

1 pcs 43x35 h10mm



1 pcs 65x35 h10mm



1 pcs 50x40 h10mm



Cod. **90-4020**
8 pcs 40x47 h10mm

1 pcs 55x55 h10mm



1 pcs 55x55 h10mm



1 pcs 55x35 h10mm





Cod. **90-4060**
14 pcs Ø30 h11mm



Cod. **90-4061**
14 pcs 32x25 h14mm



Cod. **90-15505**
11 pcs 45x43 h12mm



Cod. **90-4103**
1 pcs 60x48 h10mm



1 pcs 42x50 h5mm



1 pcs 65x40 h13mm



1 pcs 60x43 h10mm



1 pcs 38x42 h5mm



1 pcs 60x48 h10mm



1 pcs 45x50 h10mm



1 pcs 45x30 h10mm



1 pcs 57x42 h10mm



Cod. **90-4015**
8 pcs 46x48 h5mm



Cod. **90-4105**
1 pcs 48x53 h10mm



1 pcs 45x55 h10mm



2 pcs 55x65 h10mm



1 pcs 63x47 h10mm



1 pcs 55x40 h10mm



Cod. **90-4107**
2 pcs 50x40 h7mm



3 pcs 35x42 h7mm



3 pcs Ø35 h7mm



3 pcs 45x32 h7mm



Cod. **90-4108**
4 pcs Ø30 h8mm



4 pcs 35x25 h8mm



4 pcs Ø35 h8mm



4 pcs 35x26 h8mm



Cod. **90-4109**
4 pcs 50x30 h6mm



4 pcs 48x25 h6mm



4 pcs 48x30 h6mm



4 pcs 45x30 h6mm



Cod. **90-4110**
6 pcs 45x35 h8mm



5 pcs 40x35 h8mm



Cod. **90-4018**
11 pcs 40x25 h10mm





Cod. **90-4112**
3 pcs 30x65 h10mm



3 pcs 60x35 h10mm



3 pcs 65x30 h10mm



Cod. **90-4237**
2 pcs 17x90 h10mm



Cod. **90-4301**
2 pcs 59x42 h25mm



2 pcs 59x42 h25mm



Cod. **90-4303**
1 pcs 104x58 h25mm



1 pcs 104x58 h25mm



Cod. **90-4307**
2 pcs 50x35 h15mm



1 pcs 35x25 h4mm



1 pcs 35x25 h4mm



2 pcs 45x30 h13mm



1 pcs 28x38 h10mm



1 pcs 28x38 h10mm



1 pcs 35x25 h10mm



1 pcs 40x30 h10mm



1 pcs 40x30 h10mm



Cod. **90-4309**
1 pc 48x32 h3mm



1 pc 48x32 h3mm



1 pc 55x18 h3mm



1 pc 47x32 h3mm



1 pc 32x60 h3mm



1 pc 22x18 h7mm



Cod. **90-4314**
2 pcs 90x80 h37mm



Cod. **90-4059**
18 pcs Ø30 h8mm



Cod. **90-4021**
8 pcs 42x48 h10mm



Cod. **90-4401**
1 pcs 140x130 h45 mm



1 pcs 140x130 h45 mm



Cod. **90-4607**
1 pcs Ø150 h15mm



Cod. **90-4406**
1 pcs 250x160 h75 mm



1 pcs 250x160 h75 mm



Cod. **90-4608**
1 pcs Ø150 h15mm



Arabesques



Cod. **90-5105**

2 pcs 45x30 h8mm

2 pcs 45x40 h8mm



2 pcs Ø36 h8mm

2 pcs 45x32 h8mm

2 pcs Ø35 h8mm



2 pcs 42x27 h8mm

2 pcs 38x36 h8mm

1 pcs Ø36 h8mm



Cod. **90-5600**

8 pcs Ø29 h29mm



Cod. **90-5602**

11 pcs Ø29 h24mm



Cod. **90-5034**

11 pcs 42x32 h12mm



Cod. **90-5111**

1 pcs Ø30 h15mm

1 pcs Ø30 h15mm

1 pcs Ø30 h15mm



1 pcs Ø25 h15mm

1 pcs Ø30 h15mm

1 pcs Ø30 h15mm

1 pcs Ø30 h15mm

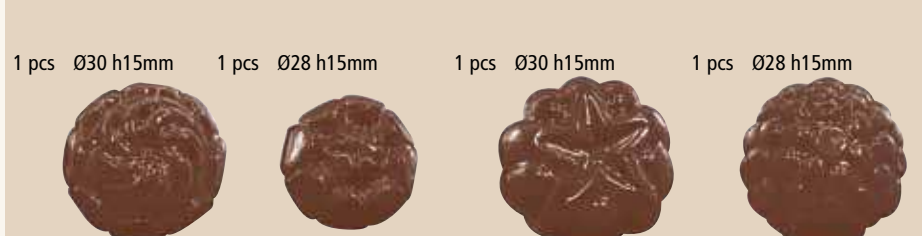

1 pcs Ø30 h15mm

1 pcs Ø28 h15mm

1 pcs Ø30 h15mm

1 pcs Ø28 h15mm



Cod. **90-5604**

11 pcs Ø27 h17mm



Cod. **90-5605**

11 pcs Ø36 h18mm



Cod. **90-5607**

8 pcs Ø38 h20mm



Cod. **90-5112**

1 pcs 35x20 h18mm

1 pcs 35x20 h18mm

1 pcs 35x20 h18mm

1 pcs 35x20 h18mm

1 pcs 35x20 h18mm



1 pcs 35x20 h18mm

1 pcs 35x20 h18mm

1 pcs 35x20 h18mm

1 pcs 35x20 h18mm

1 pcs 35x20 h18mm

1 pcs 35x20 h18mm

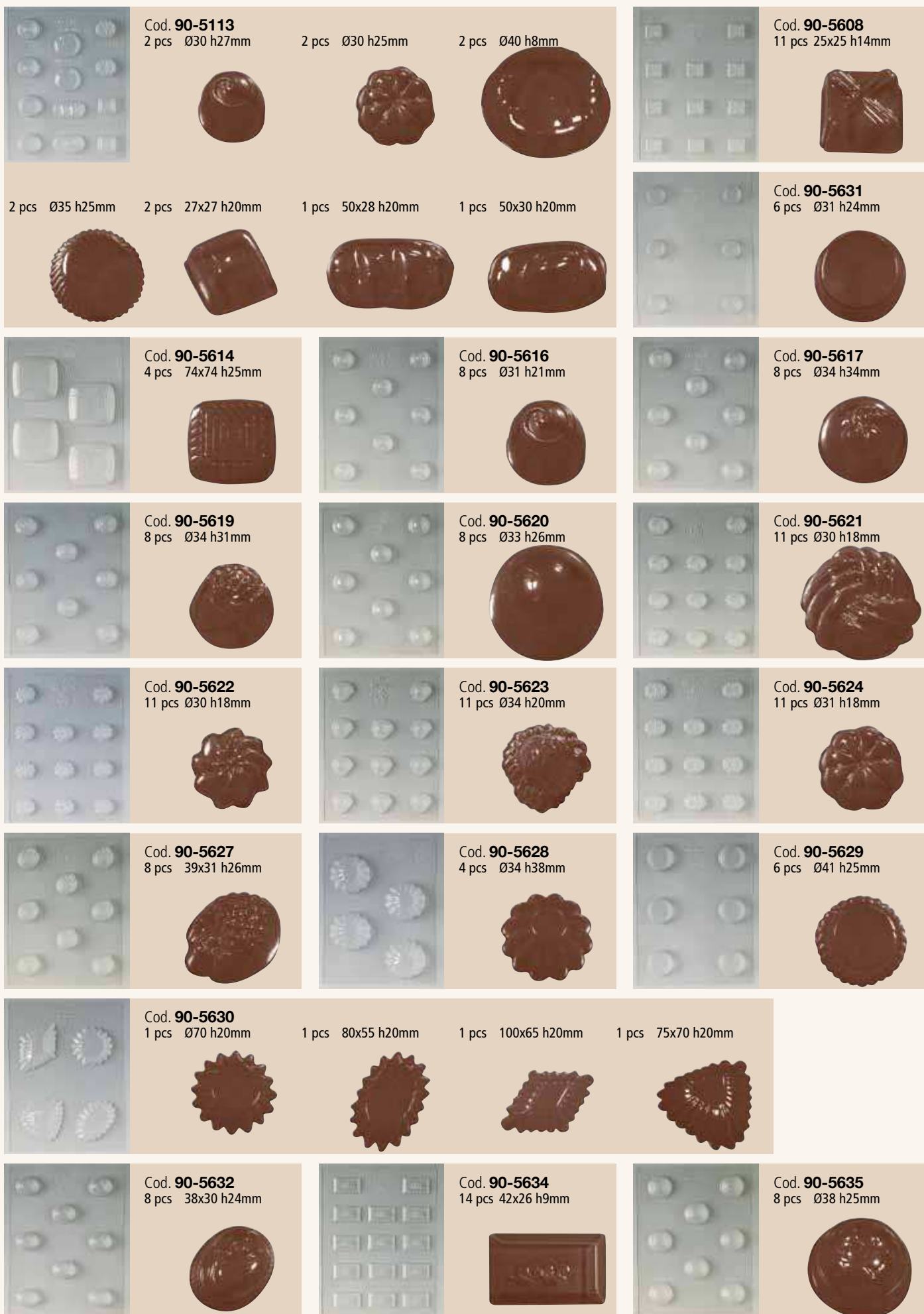





Cod. **90-13064**
2 pcs Ø50 h5mm

2 pcs Ø40 h5mm

2 pcs Ø32 h5mm



2 pcs 55x50 h5mm

1 pcs 70x40 h5mm

1 pcs 80x45 h5mm

1 pcs 55x30 h5mm



Cod. **90-13189**
4 pcs 147x124 h13mm



Cod. **90-13303**
12 pcs 25x30 h10mm



Cod. **90-13069**
8 pcs 46x25 h8mm

10 pcs Ø26 h8mm



Cod. **90-C9316**
1 pcs Ø70 h15mm

1 pcs Ø70 h15mm



Cod. **90-13324**
2 pcs 30x25 h8mm

2 pcs Ø25 h8mm

1 pcs 45x21 h8mm

1 pcs 50x30 h8mm

2 pcs 40x20 h8mm



1 pcs 40x25 h8mm

1 pcs 45x20 h8mm

1 pcs Ø30 h8mm

1 pcs 45x18 h8mm

1 pcs 40x40 h8mm

1 pcs 42x30 h8mm



Cod. **90-13326**
1 pcs 55x30 h10mm

1 pcs Ø40 h15mm

1 pcs 40x40 h8mm

1 pcs 52x32 h13mm



1 pcs 50x30 h13mm

1 pcs 40x32 h12mm

1 pcs 60x35 h12mm

1 pcs 60x23 h10mm

2 pcs 30x50 h10mm



Cod. **90-13307**
14 pcs 42x19 h14mm



Cod. **90-14801**
11 pcs Ø44 h9mm



Cod. **90-13308**
11 pcs 38x31 h19mm





Cod. **90-5005**
18 pcs 29x22 h8mm



Cod. **90-5014**
11 pcs Ø40 h12mm



Cod. **90-5015**
11 pcs Ø30 h16mm



Cod. **90-5020**
11 pcs 34x20 h18mm



Cod. **90-5022**
11 pcs Ø35 h8mm



Cod. **90-5023**
11 pcs 53x25 h9mm



Cod. **90-5029**
18 pcs Ø28 h8mm



Cod. **90-5031**
11 pcs 34x34 h8mm



Cod. **90-5032**
11 pcs 35x25 h5mm

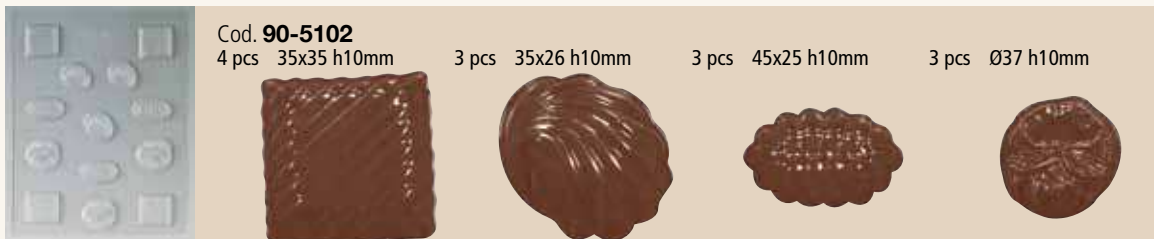

Cod. **90-5102**
4 pcs 35x35 h10mm 3 pcs 35x26 h10mm 3 pcs 45x25 h10mm 3 pcs Ø37 h10mm



Cod. **90-5104**
2 pcs 30x30 h18 mm 2 pcs 30x30 h18 mm 2 pcs 27x27 h18 mm 2 pcs 28x21 h18 mm 1 pcs Ø26 h18 mm 1 pcs Ø28 h18 mm

Sport and Jobs



Cod. **90-6302**
2 pcs Ø72 h35mm



Cod. **90-6303**
3 pcs 68x43 h18mm 3 pcs 68x43 h18mm



Cod. **90-6401**
1 pcs 140x90 h44 mm 1 pcs 140x90 h44 mm

Cod. **90-6604**
 1 pcs 80x80 h14mm 2 pcs 200x18 h10mm



Cod. **90-6607**
 1 pcs 145x106 h12mm



Cod. **90-6804**
 2 pcs 90x52 h15 mm 1 pcs 50x75 h4mm 1 pcs 45x35 h25 mm



Cod. **90-1000**
 1 pcs 210x64 mm



Cod. **90-12682**
 1 pcs 95x50 h8 mm 1 pcs 100x40 h8 mm 1 pcs 113x42 h8 mm 1 pcs 132x40 h8 mm 1 pcs 90x23 h8 mm 1 pcs 67x42 h8 mm



Cod. **90-13414**
 4 pcs 30x30 h4mm 4 pcs 28x28 h4mm 4 pcs 30x22 h4mm 4 pcs 30x27 h4mm



Cod. **90-13452**
 2 pcs 60x35 h18 mm 2 pcs 53x35 h18 mm 2 pcs 35x22 h10 mm



Cod. **90-13027**
 11 pcs 42x29 h8mm



1 pcs 53x30 h15 mm 1 pcs 53x30 h15 mm 2 pcs 45x30 h14 mm 2 pcs 50x30 h14 mm



Cod. **90-13790**
 1 pcs 125x145 h10mm



Cod. **90-13453**
 2 pcs 85x40 h15 mm 2 pcs 75x40 h15 mm 2 pcs 60x32 h15 mm



Cod. **90-6008**
 10 pcs Ø36 h20mm



1 pcs 55x35 h15 mm 1 pcs 55x35 h15 mm 2 pcs 50x30 h15 mm 2 pcs 40x30 h10 mm



Cod. **90-9991**
 4 pcs 160x40 h20mm



Cod. **90-13477**
 1 pcs 99x57 h5mm 1 pcs 99x57 h5mm 1 pcs 99x57 h5mm 1 pcs 99x57 h5mm

Cod. **90-13912**
 2 pcs 60x25 h8 mm 2 pcs 50x50 h8 mm 2 pcs 40x7 h2 mm

2 pcs 55x20 h8 mm 1 pcs 75x30 h8 mm 2 pcs 82x35 h8 mm 2 pcs 75x30 h8 mm

Cod. **90-6013**
 11 pcs 44x24 h5mm

Cod. **90-6012**
 8 pcs 35x48 h17mm

Cod. **90-14666**
 1 pcs 140x50 h8mm

1 pcs 140x50 h8mm 1 pcs 26x38 h2mm

1 pcs 26x38 h2mm 1 pcs 26x38 h2mm

1 pcs 26x38 h2mm 1 pcs 26x38 h2mm

Cod. **90-14668**
 1 pcs 90x60 h20mm

1 pcs 90x60 h20mm 1 pcs 75x20 h3mm

1 pcs 75x37 h3mm 1 pcs 75x35 h2mm

1 pcs 75x25 h3mm 1 pcs 75x40 h3mm

Cod. **90-14687**
 1 pcs 190x50 h7mm

1 pcs 150x45 h7mm 1 pcs 115x25 h7mm

1 pcs 115x72 h7mm 1 pcs 135x50 h7mm

Cod. **90-14613**
 11 pcs 36x27 h22mm

Cod. **90-15331**
 2 pcs 35x50 h10mm 2 pcs 30x50 h10mm 2 pcs 30x60 h10mm 2 pcs 30x60 h10mm



Cod. **90-13914**

6 pcs 40x47 h6 mm

1 pcs 45x35 h8 mm

1 pcs 45x35 h8 mm

1 pcs 45x35 h8 mm

1 pcs 45x35 h8 mm



Cod. **90-13915**

1 pcs 48x106 h6 mm 2 pcs 50x25 h6 mm 2 pcs 30x30 h6 mm 2 pcs 40x26 h6 mm 2 pcs 40x20 h6 mm 2 pcs 30x25 h6 mm



Cod. **90-13916**

4 pcs 29x15 h8 mm 4 pcs 29x15 h8 mm 4 pcs 29x15 h8 mm 4 pcs 29x15 h8 mm 4 pcs 29x15 h8 mm 4 pcs 29x15 h8 mm



Cod. **90-15332**

4 pcs 30x37 h5mm

4 pcs 22x23 h5mm

4 pcs 25x28 h5mm

4 pcs 30x35 h5mm



Cod. **90-15362**

1 pcs 175x63

2 pcs 60x25 h8mm



Cod. **90-15386**

1 pc 90x150 h8mm

1 pc 80x145 h8mm



Cod. **90-15365**

1 pc 60x100 h10mm

2 pcs 30x85 h10mm

2 pcs 40x65 h10mm



Cod. **90-13782**

2 pcs 95x40 h8 mm



Cod. **90-15391**

2 pcs 150x100 h12mm



Cod. **90-15783**

1 pc 170x17 h15mm



2 pcs 32x22 h10mm

2 pcs 28x25 h10 mm



Cod. **90-15785**

1 pc 200x90 h15mm



Cod. **90-15784**

1 pc 190x120 h15mm



Cod. **90-15304**

8 pcs 45x46 h14mm



Special occasions



Animals



Cod. **90-9395**
 1 pcs 70x75 h8mm 1 pcs 70x75 h8mm 1 pcs 61x48 h12mm 1 pcs 61x48 h12mm

Cod. **90-11185**
 3 pcs 35x52 h5 mm 3 pcs 35x45 h5 mm 2 pcs 32x48 h5 mm 2 pcs 25x50 h5 mm 2 pcs 32x43 h5 mm 2 pcs 31x48 h5 mm

Cod. **90-9396**
 3 pcs 54x45 h15mm 3 pcs 54x45 h15mm

Cod. **90-11910**
 4 pcs 64x42 h8mm 4 pcs 64x42 h8mm

Cod. **90-11210**
 3 pcs 30x50 h8mm 3 pcs 50x45 h8mm 3 pcs 31x48 h8mm 2 pcs 42x57 h8mm

Cod. **90-11274**
 14 pcs 32x28 h8mm

Cod. **90-11707**
 11 pcs 35x30 h10mm

Cod. **90-11708**
 8 pcs 53x33 h14mm

Cod. **90-11709**
 11 pcs 30x30 h10mm

Cod. **90-11206**
 11 pcs Ø32 h14mm

Cod. **90-12815**
 13 pcs 48x28 h13mm

Cod. **90-12816**
 2 pcs 50x20 h8mm 2 pcs 27x27 h10mm 2 pcs 40x35 h10mm

Cod. **90-12855**
 1 pcs 130x160 h22mm

2 pcs 53x27 h8mm 2 pcs Ø42 h8mm 2 pcs 52x27 h8mm 2 pcs 35x40 h8mm

Cod. **90-11943**
 1 pcs 75x85 h28mm 1 pcs 75x85 h28mm 1 pcs 64x45 h5mm 1 pcs 64x45 h5mm

Cod. **90-12817**
 5 pcs 25x30 h8mm 4 pcs Ø30 h8mm 4 pcs Ø35 h8mm 5 pcs 45x25 h8mm

Cod. **90-12819**
 4 pcs 40x32 h8mm 4 pcs 30x50 h10mm 3 pcs 25x60 h10mm

Cod. **90-12961**
 6 pcs 72x42 h18mm

Cod. **90-12840**
 4 pcs Ø40 h9mm 4 pcs Ø40 h9mm

Fronte - Front Retro - Back

Cod. **90-12841**
 4 pcs Ø35 h10mm 4 pcs Ø35 h10mm

Fronte - Front Retro - Back

Cod. **90-12869**
 1 pcs 100x120 h20mm 1 pcs 100x120 h20mm

Sopra - Up Sotto - Down

Cod. **90-11202**
 12 pcs 60x35 h10mm

Cod. **90-12876**
 6 pcs Ø65 h20mm

Cod. **90-12903**
 14 pcs 40x30 h12mm

Cod. **90-12955**
 5 pcs Ø20 h24mm

Cod. **90-13021**
 14 pcs 36x27 h8mm

Cod. **90-13179**
 2 pcs 55x70 h5mm 2 pcs 70x88 h5mm 1 pcs 75x95 h8mm

Cod. **90-13611**
 3 pcs 35x30 h7 mm 3 pcs 47x32 h8 mm 3 pcs 45x32 h8 mm 1 pcs 43x35 h8 mm 2 pcs 35x41 h8 mm



Letters and Numbers



SILICONE 3D MOULDS

Silicone
Idea
sweet creation

Gli stampi, realizzati in resistente silicone alimentare, consentono la produzione di fantastici soggetti tridimensionali, ognuno dei quali ha la straordinaria caratteristica di suscitare dolci emozioni.

La professionalità e l'esperienza acquisita negli anni hanno notevolmente contribuito alla creazione di questa nuova collezione, ogni singolo soggetto è stato scelto ed attentamente studiato con il preciso intento di proporre ai nostri clienti soggetti esclusivi ed originali senza in alcun modo trascurare le reali necessità del pasticciere.

Martellato realizza e produce soggetti personalizzati su richiesta.

The moulds, made of durable food-safe silicone, allow the production of fantastic three-dimensional subjects, each of which has the unique feature of arousing sweet emotions.

Professionalism and the experience gained over the years have greatly contributed to the creation of this new collection, each subject was chosen and carefully designed with the specific intent to offer our customers exclusive and original subjects without neglecting the real needs of the pastry chef.

Martellato creates and manufactures custom subjects on request.

HOW TO USE



Stampo in silicone gufo
Owl silicone mould

Cod. **30SM005**

Soggetto/Figure: 77x55 h130mm

Halloween

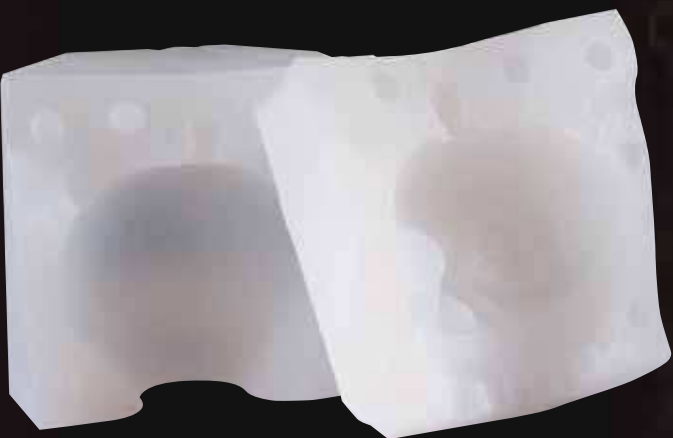

Stampi bara con scheletro halloween
Skeleton and coffin silicone moulds

Cod. **30SM070**

Soggetto/Figure: 80x65 h73mm



Stampo silicone teschio halloween
Halloween skull silicone mould

Cod. **30SM086**

Soggetto/Figure: 95x80 h100mm



Stampo silicone scheletro con mantello
Skeleton with coat silicone mould

Cod. **30SM013**

Soggetto/Figure: 75x55 h100mm



Stampo silicone Frankenstein
Frankenstein silicone mould

Cod. **30SM016**

Soggetto/Figure: 75x50 h90mm



Stampo silicone zucca con gatto
Pumpkin with cat silicone mould

Cod. **30SM014**

Soggetto/Model: 85x70 h85mm



Stampo silicone Dracula
Dracula silicone mould

Cod. **30SM015**

Soggetto/Figure: 55x50 h85mm



Stampo silicone vampiro
Vampire silicone mould

Cod. **30SM019**

Soggetto/Figure: 120x55 h95mm

Per visualizzare imballi ed espositori disponibili vedi da pg 128 a pg 133
To see available packaging and displays see from page 128 to page 133

Mini Halloween



Stampo silicone mini gufo di halloween
Halloween mini owl silicone mould

Cod. **30SM061**

Soggetto/Figure: 45x37 h65mm



Stampo silicone mini zucchetto di halloween
Halloween mini pumpkin silicone mould

Cod. **30SM062**

Soggetto/Figure: 40x38 h65mm



Stampo silicone mini streghetta di halloween
Halloween mini witch silicone mould

Cod. **30SM063**

Soggetto/Figure: 50x35 h70mm



Stampo silicone mini fantasma di halloween
Halloween mini ghost silicone mould

Cod. **30SM064**

Soggetto/Figure: 70x38 h68mm

Lolly Halloween



Soggetto/Figure: 72x60mm
pipistrello
bat



Soggetto/Figure: 52x70mm
zucchetto con gatto
pumpkin with cat



Soggetto/Figure: 65x65mm
fantasma
ghost



Soggetto/Figure: 45x70mm
strega
witch



Soggetto/Figure: 65x65mm
mummia
mummy

Stampo silicone lollipop halloween
halloween lollipop silicone mould

Cod. **30SML001**

Produttività/productivity: 5 lollipop
Vassoio incluso - Tray included:
395x143mm

Per visualizzare imballi ed espositori disponibili vedi da pg 128 a pg 133
To see available packaging and displays see from page 128 to page 133

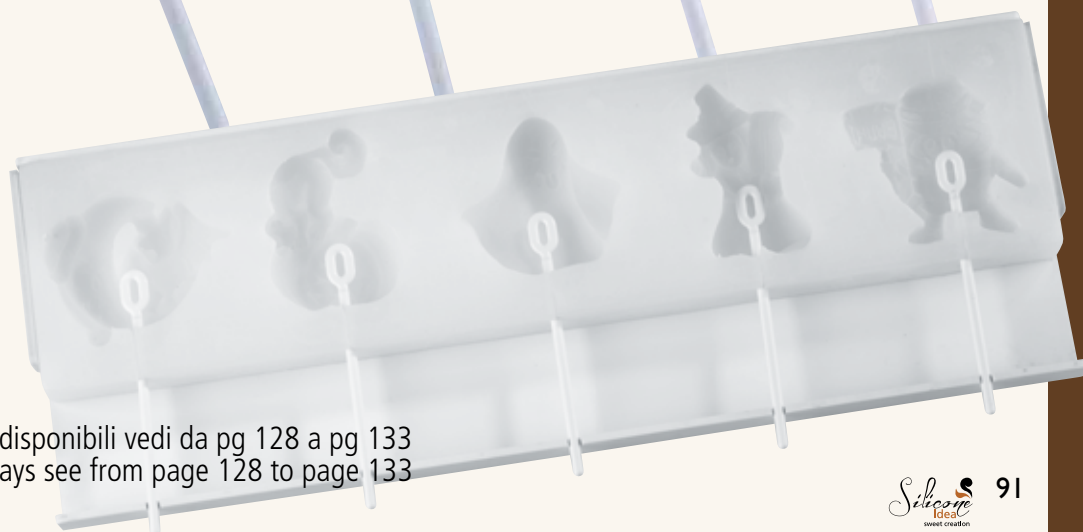

Christmas



Stampo silicone renna con cuore
Reindeer with heart silicone mould
Cod. **30SM001**
Soggetto/Figure: 85x40 h117mm



Stampo silicone orsetto Babbo Natale
Santa Claus bear silicone mould
Cod. **30SM002**
Soggetto/Figure: 80x70 h135mm



Stampo silicone Pupazzo con lanterna
Snowman with lantern silicone mould
Cod. **30SM004**
Soggetto/Figure: 90x75 h130mm



Stampo silicone Babbo Natale
Santa Claus silicone mould
Cod. **30SM003**
Soggetto/Figure: 60x65 h130mm



Stampo silicone Babbo Natale gnomo
Santa Claus gnome silicone mould
Cod. **30SM007**
Soggetto/Figure: 125x75 h115mm



Stampo silicone pupazzo con sciarpa
Snowman with scarf silicone mould

Cod. **30SM008**

Soggetto/Figure: 105x95 h125mm



Stampo silicone renna simpatica
Funny reindeer silicone mould

Cod. **30SM009**

Soggetto/Figure:
65x80 h100mm



Stampo silicone angioletto con stella
Angel and star silicone mould

Cod. **30SM058**

Soggetto/Figure: 65x45 h80mm



Stampo silicone Angioletto con libro
Angel with book silicone mould

Cod. **30SM010**

Soggetto/Figure: 80x60 h105mm



Stampo silicone Angelo con cornetta
Angel with trumpet silicone mould

Cod. **30SM018**

Soggetto/Figure: 90x75 h130mm



Stampo silicone angelo con cometa
angel with comet silicone mould

Cod. **30SM087**

Soggetto/Figure: 110x40 h70mm



Stampo silicone Gesù bambino
Baby Jesus silicone mould

Cod. **30SM072**

Soggetto/Figure: 75x55 h30mm



Stampo silicone San Giuseppe
Saint Joseph silicone mould

Cod. **30SM073**

Soggetto/Figure: 65x55 h110mm



Stampo silicone Maria
Holy Mary silicone mould

Cod. **30SM074**

Soggetto/Figure: 50x47 h88mm



Stampo silicone asinello
Donkey silicone mould

Cod. **30SM076**

Soggetto/Figure: 70x40 h68mm



Stampo silicone bue
Ox silicone mould

Cod. **30SM075**

Soggetto/Figure: 75x40 h68mm



Stampo silicone Presepe
Nativity silicone mould

Cod. **30SM017**

Soggetto/Figure: 150x75 h120mm



Sacra famiglia
Nativity

Cod. **30SM077**

Kit 5 stamper
Set 5 moulds

Christmas Decorations



Cod. **30SMA001**

Soggetto/Figure: 55x85x15mm



Cod. **30SMA002**

Soggetto/Figure: 55x85x15mm



Cod. **30SMA003**

Soggetto/Figure: 55x85x15mm



Cod. **30SMA004**

Soggetto/Figure: 55x85x15mm



Cod. **30SMA005**

Soggetto/Figure: 55x85x15mm



Cod. **30SMA006**

Soggetto/Figure: 55x85x15mm



Cod. **30SMA007**

Soggetto/Figure: Ø60 h75mm



Cod. **30SMA008**

Soggetto/Figure: Ø60 h75mm



Cod. **30SMA009**

Soggetto/Figure: 85x95x20mm



Cod. **30SMA010**

Soggetto/Figure: 75x90x20mm



Cod. **30SMA011**

Soggetto/Figure: 65x88x20mm



Cod. **30SMA012**

Soggetto/Figure: 75x92x20mm

Mini Christmas



Stampo silicone mini candela di natale
Mini Christmas candle silicone mould

Cod. **30SM079**

Soggetto/Figure: 55x40 h65mm



Stampo silicone mini Babbo nel camino
Mini Santa in chimney silicone mould

Cod. **30SM080**

Soggetto/Figure: 60x32 h70mm



Stampo silicone mini calza befana
Mini Christmas stocking silicone mould

Cod. **30SM081**

Soggetto/Figure: 55x40 h65mm



Stampo silicone mini pupazzo di neve
Mini snowman silicone mould

Cod. **30SM082**

Soggetto/Figure: 55x40 h65mm

Lolly Christmas



Soggetto/Figure: 70x80mm
elfo seduto
sitting elf



Soggetto/Figure: 75x85mm
gatto
cat



Soggetto/Figure: 70x85mm
Babbo Natale
Santa Claus



Soggetto/Figure: 80x80mm
renna
reindeer



Soggetto/Figure: 60x85mm
pupazzo di neve
snowman

Stampo silicone lollipop Natale
Christmas lollipops silicone mould

Cod. **30SML002**

produttività/productivity: 5 lollipop
Vassoio incluso - Tray included: 395x143mm



St. Valentine





Stampo silicone pinguino in love
Penguin in love silicone mould

Cod. **30SM039**

Soggetto/Figure: 55x45 h80mm



Stampo silicone pinguini innamorati
Penguins in love silicone mould

Cod. **30SM040**

Soggetto/Figure: 85x50 h80mm

Lolly Love



Soggetto/Figure: 65x80mm
cupido
cupid



Soggetto/Figure: 65x85mm
bambina con ombrello girl with
umbrella



Soggetto/Figure: 73x80mm
giovani innamorati
young loving couple



Soggetto/Figure: 60x85mm
bambino innamorato
little boy in love



Soggetto/Figure: 70x80mm
bambina innamorata
little girl in love



Stampo silicone lollipop San Valentino
Valentine's day lollipops silicone mould

Cod. **30SML003**

produttività/productivity: 5 lollipop
Vassoio - Tray: 395x143mm



Stampo silicone cofanetto bocciolo di rosa
Rose dub case silicone mould
Cod. **30SM049**
Soggetto/Model: Ø73 h60mm





Stampo silicone cofanetto cuore con rose
Heart with roses case silicone mould

Cod. **30SM050**

Soggetto/Model: 95x90 h50mm



Ceremonies





Stampo silicone pergamena comunione
Parchment communion silicone mould

Cod. **30SM043**

Soggetto/Model: 150x100 h25mm



Stampo silicone pergamena cresima
Parchment confirmation silicone mould

Cod. **30SM037**

Soggetto/Model: 100x150 h25mm



Stampo silicone civetta laureato
Graduate owl silicone mould

Cod. **30SM047**

Soggetto/Figure: 65x60 h85mm



Stampo silicone libro
Book silicone mould

Cod. **30SM038**

Soggetto/Model: 145x100 h20mm

Baptism



Stampo silicone orsetto con ciuccio
Little bear with pacifier silicone mould

Cod. **30SM036**

Soggetto/Figure: 65x60 h80mm



Stampo silicone cicogna con bebè
White stork with baby silicone mould

Cod. **30SM033**

Soggetto/Figure: 120x75 h115mm



Stampo silicone bebè che dorme
Sleeping baby silicone mould

Cod. **30SM011**

Soggetto/Figure: 90x50 h30mm

Stampo silicone cuscino
Pillow silicone mould

Cod. **30SM012**

Soggetto/Model: 112x75 h30mm



Stampo silicone bimbo su conchiglia
Child on shell silicone mould

Cod. **30SM085**

Soggetto/Figure: 105x65 h30mm



Marriage





Stampo silicone sposi stilizzati piccoli
Small stylized married couple silicone mould

Cod. **30SMW02**

Soggetto/Figure: 45x35 h120mm



Stampo silicone sposi stilizzati grandi
Big stylized married couple silicone mould

Cod. **30SMW01**

Soggetto/Figure: 80x35 h140mm



Stampo silicone sposi simpatici
Happy couple in the car silicone mould

Cod. **30SMW03**

Soggetto/Figure: 145x80 h120mm



Stampo silicone targa sposi
Married couple plate silicone mould

Cod. **30SMW04**

Soggetto/Figure: 115x127 h20mm

Other Festivity



Stampo silicone coccinella felice
Happy ladybug silicone mould

Cod. **30SM041**

Soggetto/Figure: 60x40 h100mm





Stampo silicone coccinella stesa
Lying ladybug silicone mould

Cod. **30SM042**

Soggetto/Figure: 55x80 h85mm



Stampo silicone topolino con cravatta
Mouse with tie silicone mould

Cod. **30SM032**

Soggetto/Figure: 57x55 h90mm





Old Style



Stampo silicone scooter vintage
Vintage scooter silicone mould

Cod. **30SM071**

Soggetto/Model: 80x50 h75mm



Stampo silicone macchina fotografica
Camera silicone mould

Cod. **30SM046**

Soggetto/Model: 78x62 h65mm



Stampo silicone valigia
Luggage silicone mould

Cod. **30SM051**

Soggetto/Model: 125x60 h110mm



Stampo silicone macchina da cucire
Sewing machine silicone mould

Cod. **30SM045**

Soggetto/Model: 120x72 h90mm

Shoes





Stampo silicone scarpa donna
women's shoe silicone mould

Cod. **30SM084**

Soggetto/Model: 110x45 h105mm



Stampo silicone scarpa sneaker
Sneaker silicone mould

Cod. **30SM054**

Soggetto/Model: 93x40 h55mm



Stampo silicone scarpa uomo
Men's shoe silicone mould

Cod. **30SM083**

Soggetto/Model: 135x45 h45m



Stampo silicone bimbo calciatore
Footballer silicone mould

Cod. **30SM044**

Soggetto/Figure:
62x35 h105mm



Season and Animals



Stampo silicone bimba eschimese
Eskimo girl silicone mould

Cod. **30SM056**

Soggetto/Figure: 50x50 h80mm



Stampo silicone bimbo eschimese
Eskimo boy silicone mould

Cod. **30SM057**

Soggetto/Figure: 50x50 h85mm



Stampo silicone bimbo con palla neve
Snowball child silicone mould

Cod. **30SM055**

Soggetto/Figure: 60x50 h80mm





Stampo silicone funghetti nel bosco
Wood mushrooms silicone moulds

Cod. **30SM059**

Soggetto/Figure: 70x55 h85mm



Stampo silicone trio funghi
3 mushrooms silicone mould

Cod. **30SM060**

Soggetto/Figure: 80x75 h115mm



Stampo silicone riccio
Hedgehog silicone mould

Cod. **30SM034**

Soggetto/Figure: 65x70 h70mm



Stampo silicone amico del bosco
Wood friend silicone mould

Cod. **30SM078**

Soggetto/Figure: 60x40 h70mm



Stampo in silicone gufo
Owl silicone mould

Cod. **30SM005**

Soggetto/Figure: 77x55 h130mm



Stampo silicone scoiattolo
Squirrel silicone mould

Cod. **30SM006**

Soggetto/Figure: 80x50 h112mm



Stampo silicone elefante
Elephant silicone mould

Cod. **30SM035**

Soggetto/Figure: 110x70 h120mm



Stampo silicone ippopotamo
Hyppo silicone mould

Cod. **30SM031**

Soggetto/Figure: 80x65 h95mm



Mini Farm



Stampo silicone trattore
Tractor silicone mould

Cod. **30SM069**

Soggetto/Model: 75x60 h67mm



Stampo silicone gatto mini fattoria
Mini farm cat silicone mould

Cod. **30SM065**

Soggetto/Figure: 60x40 h55mm



Stampo silicone cane mini fattoria
Mini farm dog silicone mould

Cod. **30SM066**

Soggetto/Figure: 45x45 h68mm



Stampo silicone mucca mini fattoria
Mini farm cow silicone mould

Cod. **30SM067**

Soggetto/Figure: 35x40 h60mm



Stampo silicone maiale mini fattoria
Mini farm pig silicone mould

Cod. **30SM068**

Soggetto/Figure: 40x50 h65mm





Stampo silicone big pecora con fiore
Big sheep and flower silicone mould

Cod. **30SM028**

Soggetto/Figure: 80x75 h130mm



Stampo silicone pecora con salopette
Sheep in overall silicone mould

Cod. **30SM029**

Soggetto/Figure: 75x60 h125mm



Stampo silicone pecora con bebè
Sheep with baby silicone mould

Cod. **30SM030**

Soggetto/Figure: 70x70 h125mm



Stampo silicone pecora con vestitino
Sheep with dress silicone mould

Cod. **30SM020**

Soggetto/Figure: 80x65 h110mm



Stampo silicone pecora con maglietta
Sheep with shirt silicone mould

Cod. **30SM021**

Soggetto/Figure: 80x60 h115mm

Easter





Stampo silicone gallina con uovo orizzontale
Chicken and horizontal egg silicone mould

Cod. **30SM025**

Soggetto/Figure: 100x77 h125mm



Stampo silicone coniglio con ovetto
Rabbit and small egg silicone mould

Cod. **30SM027**

Soggetto/Figure: 55x65 h110mm



Stampo silicone gallina con uovo verticale
Chicken and vertical egg silicone mould

Cod. **30SM024**

Soggetto/Figure: 85x75 h125mm



Stampo silicone coniglio con carriola
Rabbit and wheelbarrow silicone mould

Cod. **30SM022**

Soggetto/Figure: 105x55 h120mm



Stampo silicone coniglio con uovo pasquale
Rabbit and easter egg silicone mould

Cod. **30SM026**

Soggetto/Figure: 77x80 h120mm



Stampo silicone coniglio con carota
Rabbit and carrot silicone mould

Cod. **30SM023**

Soggetto/Figure: 100x80 h140mm

Carnival



Stampo silicone clown
Clown silicone mould

Cod. **30SM048**

Soggetto/Figure: 73x50 h80mm



Stampo silicone maschera carnevale grande
Big carnival mask silicone mould

Cod. **30SM052**

Soggetto/Model: 90x120 h77mm



Stampo silicone maschera carnevale piccola
Small carnival mask silicone mould

Cod. **30SM053**

Soggetto/Model: 80x100 h70mm

PIECES MOULDS



Cod. 30SMTP01

Stampo - Mould: 400x300 mm

Misura - Size:

260x85 h 310mm

Spessore - Thickness: 9mm

Coppia di sposi - married couple: 215x120 mm

Cuore grande - Big heart: 255x225 mm

Cuore piccolo - Small heart: 150x135 mm

Farfalle (ala) - Butterflies (wing): 60x70 mm

Ovale - Oval: 155x85 mm

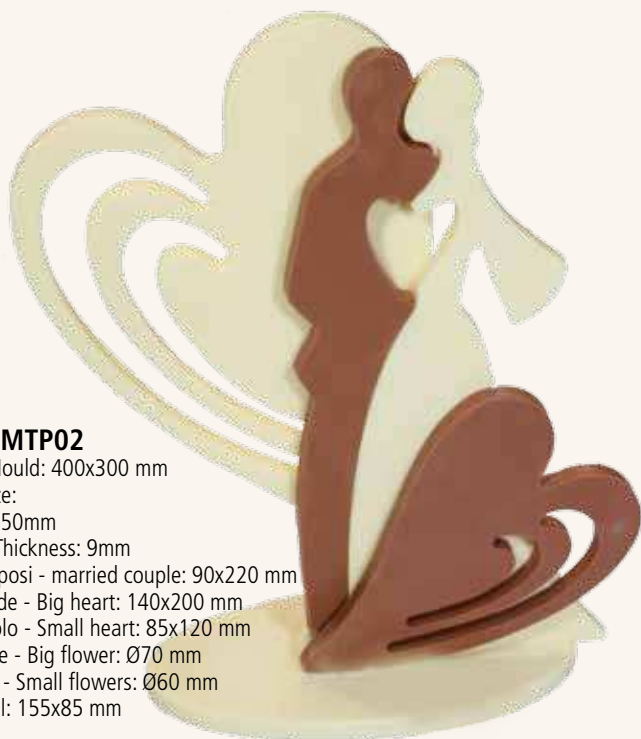

Cod. 30SMTP02

Stampo - Mould: 400x300 mm

Misura - Size:

210x85 h 250mm

Spessore - Thickness: 9mm

Coppia di sposi - married couple: 90x220 mm

Cuore grande - Big heart: 140x200 mm

Cuore piccolo - Small heart: 85x120 mm

Fiore grande - Big flower: Ø70 mm

Fiori piccoli - Small flowers: Ø60 mm

Ovale - Oval: 155x85 mm

Cod. 30SMTP03

Stampo - Mould: 400x300 mm

Misura - Size:

250x85 h 285 mm

Spessore - Thickness: 9mm

Cuore grande - Big heart: 180x200 mm

Colombe - Doves: 115x85 mm

Cuoricini - Small hearts: 45x55 mm

Cuoricini - Small hearts: 40x60 mm

Ovale - Oval: 155x85 mm





Leaves

Stampo silicone FOGLIA OVATA 01
OVATE LEAF 01 silicone mould

Cod. **30SMF01**
Soggetto/Model: 90x67mm



Stampo silicone FOGLIA OVATA 02
OVATE LEAF 02 silicone mould

Cod. **30SMF02**
Soggetto/Model: 85x57mm



Stampo silicone FOGLIA ELLITTICA 01
ELLIPTICAL LEAF 01 silicone mould

Cod. **30SMF03**
Soggetto/Model: 117x57mm



Chocolate Macaron



Stampo silicone gusci Macaron e Vassoio
Macarons shells silicone mould and Tray

Cod. **30SMT01**

produttività 24 gusci
productivity 24 shells

Soggetti/Subjects: Ø33 h12mm

Vassoio - Tray: 320x195mm



PACKAGING AND DISPLAYS



Espositore in plexiglass
Plexiglass displays

Cod. **ET001**

Misure/Size: 297x295 h 400mm

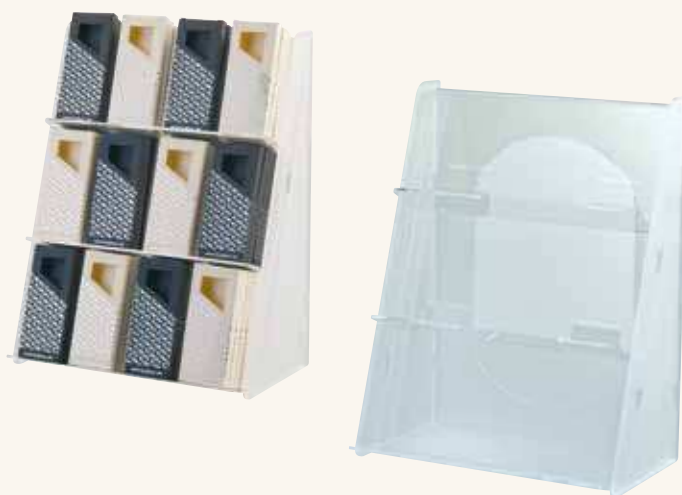

Espositore in plexiglass
Plexiglass displays

Cod. **ET003**

Misure/Size: 310x200 h 400mm



Espositore in plexiglass
Plexiglass displays

Cod. **ET004B**

Misure/Size: 315x410 h 370mm



Espositore in plexiglass
Plexiglass displays

Cod. **ET006**

Misure/Size: 305x190 h 470mm



Espositore in plexiglass
Plexiglass displays

Cod. **ET004**

Misure/Size: 245x300 h 290mm

Capacità/Capacity: 18 box cod. MSCS00225

Capacità/Capacity: 18 box cod. MSCS20125



Espositore in plexiglass per soggetti
Plexiglass display for chocolate figures

Cod. **29001**

Capacità/Capacity: 12 scatoline piccole (22BOX60)

Misure/Size: 240x300 h 285mm



Espositore in plexiglass per lollipop
Plexiglass display for lollipop

Cod. **29002**

Capacità/Capacity: 20 lollipop

Misure/Size: 350x230 h 235mm



Espositore in plexiglass per lollipop
Plexiglass display for lollipop

Cod. **29003**

Capacità/Capacity: 20 lollipop

Misure/Size: 270x180 h 145mm



Mart Box, la svolta del packaging in pasticceria

Mart Box rappresenta una soluzione pratica ed elegante alle esigenze di imballaggio delle pasticcerie. Disponibile in vari formati.

Mart Box, the turning point on pastry packaging

Mart Box is a functional and elegant solution for the packaging needs of pastry shops. Available in different sizes.

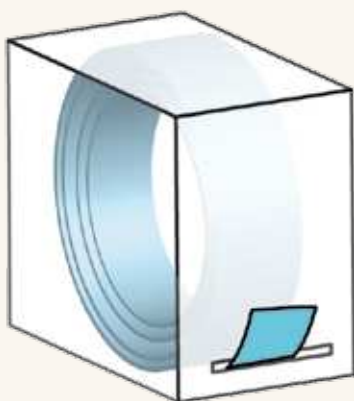

Estrai - Pull out

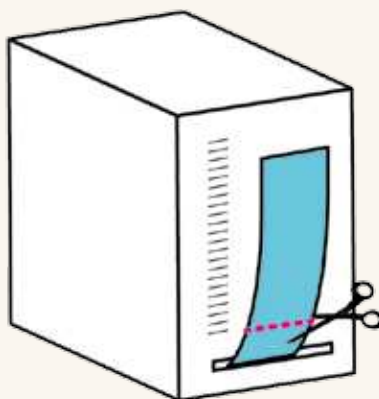

Taglia - Cut

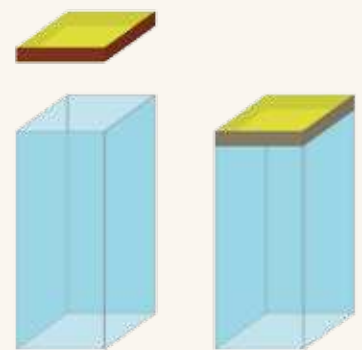

Assembla - Setting up
(coperci non inclusi
covers not included)



Cod. 22BOX85

Bobina da 15 metri
per realizzare scatole in plastica.
15m roll to make plastic boxes.
base 85x85 mm

Cod. 22BOX60

Bobina da 15 metri
per realizzare scatole in plastica.
15m roll to make plastic boxes.
base 60x60 mm

Cod. 22BOX48

Bobina da 15 metri
per realizzare scatole in plastica.
15m roll to make plastic boxes.
base 48x48 mm

**Coperchi per Mart Box
Cover for Mart Box**

Metti in mostra il lato che preferisci: abbina al tuo Mart Box uno dei seguenti coperchi double-face.
Show the favourite side: match your Mart Box with one of the following double-face cover.

lato beige / lato fantasia
beige side / fantasy side

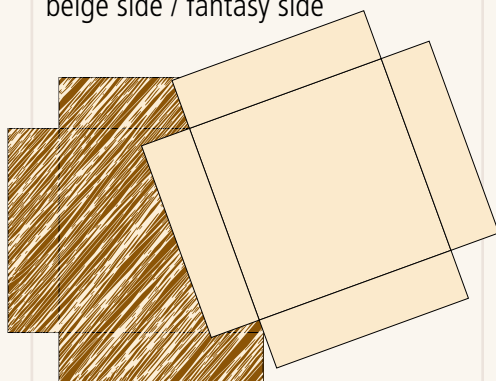

cod. **22BOX48T1** 48x48 mm 100 pcs
cod. **22BOX60T1** 60x60 mm 100 pcs
cod. **22BOX85T1** 85x85 mm 100 pcs

lato verde / lato marrone
green side / brown side

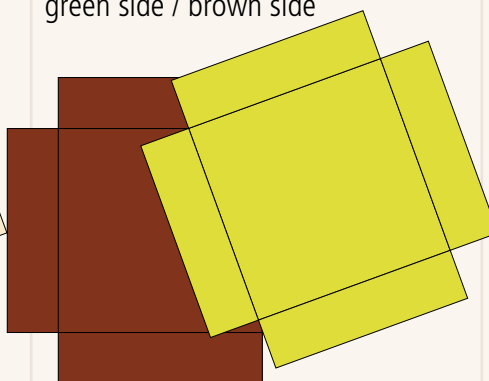

cod. **22BOX48T2** 48x48 mm 100 pcs
cod. **22BOX60T2** 60x60 mm 100 pcs
cod. **22BOX85T2** 85x85 mm 100 pcs

lato rosso / lato righe
red side / lines side

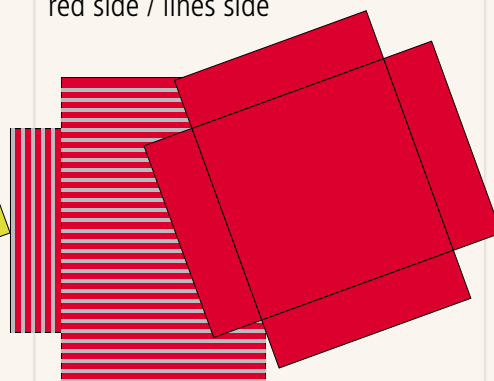

cod. **22BOX48T3** 48x48 mm 100 pcs
cod. **22BOX60T3** 60x60 mm 100 pcs
cod. **22BOX85T3** 85x85 mm 100 pcs

Scatole in plastica trasparente con alveoli trasparenti.
Boxes in transparent plastic with transparent cavities.



cod. MSC001	5 alveoli	32x27mm	160x40 h20mm	25 pcs
cod. MSC002	9 alveoli	32x27mm	110x100 h20mm	25 pcs
cod. MSC003	12 alveoli	32x27mm	220x65 h20mm	25 pcs
cod. MSC004	20 alveoli	32x27mm	160x150 h20mm	25 pcs

Scatole in plastica trasparente. Senza alveoli
Boxes in transparent plastic. Without cavities.



cod. **MSCS00225** 110x100 h20mm 25 pcs

Scatole in plastica con bordo satinato con alveoli e coperchio trasparenti.
Glazed glim boxes with transparent cavities and cover.



cod. MSC201	6 alveoli	32x27mm	100x115 h23mm	25 pcs
cod. MSC202	12 alveoli	32x27mm	210x100 h23mm	25 pcs
cod. MSC203	18 alveoli	32x27mm	210x100 h23mm	25 pcs
cod. MSC204	24 alveoli	32x27mm	210x170 h23mm	25 pcs

Scatole in plastica con bordo satinato e coperchio trasparente. Senza alveoli.
Glazed glim boxes with transparent cover. Without cavities.



cod. **MSCS20125** 100x115 h23mm 25 pcs

Scatole in plastica satinata con binari e coperchi trasparenti.
Boxes in glazed plastic with transparent lines and lids.

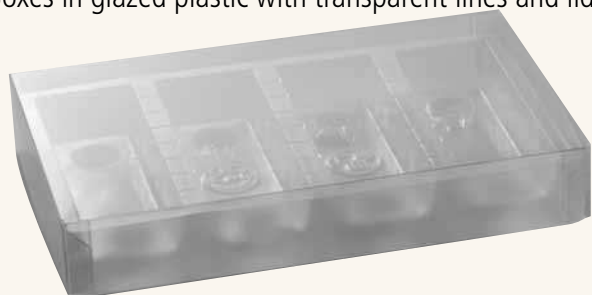

cod. MSC501	4 binari/lines	200x120 h35mm	25 pcs
cod. MSC502	6 binari/lines	270x175 h35mm	25 pcs
cod. MSC503	7 binari/lines	310x190 h35mm	25 pcs

Scatole in plastica satinata con alveoli trasparenti.
Boxes in glazed plastic with transparent cavities.



cod. MSC101	5 alveoli	32x27mm	160x40 h20mm	25 pcs
cod. MSC102	9 alveoli	32x27mm	112x97 h20mm	25 pcs
cod. MSC103	12 alveoli	32x27mm	220x65 h20mm	25 pcs
cod. MSC104	20 alveoli	32x27mm	160x150 h20mm	25 pcs

Set 3 cubi
in plastica satinata.
Set 3 cubes
in glazed plastic.



cod. MSC300	60x60 h60 - 70x70 h70 - 80x80 h75 mm
	10 pcs 10 pcs 10 pcs

Set 3 tubi
in plastica satinata.
Set 3 tubes
in glazed plastic.



cod. MSC400	Ø50 h120 - Ø60 h120 - Ø70 h120 mm
	10 pcs 10 pcs 10 pcs

**Alcuni abbinamenti.
Some matches.**

SILICONE IDEA BOX
Cod. Cod.

30SM001 22BOX85
30SM002 22BOX85
30SM003 22BOX85
30SM004 22BOX85
30SM005 22BOX85
30SM006 22BOX85
30SM009 22BOX85
30SM010 22BOX85
30SM013 22BOX85
30SM014 22BOX85
30SM016 22BOX85
30SM018 22BOX85
30SM019 22BOX60
30SM020 22BOX85
30SM021 22BOX85
30SM022 22BOX85
30SM023 22BOX85
30SM024 22BOX85
30SM025 22BOX85
30SM026 22BOX85
30SM027 22BOX60

SILICONE IDEA BOX
Cod. Cod.

30SM028 22BOX85
30SM029 22BOX85
30SM030 22BOX85
30SM031 22BOX85
30SM032 22BOX60
30SM034 22BOX85
30SM036 22BOX85
30SM039 22BOX60
30SM040 22BOX85
30SM041 22BOX60
30SM044 22BOX60
30SM046 22BOX85
30SM047 22BOX60
30SM048 22BOX60
30SM049 22BOX85
30SM054 22BOX85
30SM055 22BOX60
30SM056 22BOX60
30SM057 22BOX60
30SM058 22BOX60
30SM059 22BOX85

SILICONE IDEA BOX
Cod. Cod.

30SM060 22BOX85
30SM061 22BOX60
30SM062 22BOX60
30SM063 22BOX60
30SM064 22BOX60
30SM065 22BOX60
30SM066 22BOX60
30SM067 22BOX60
30SM068 22BOX60
30SM069 22BOX85
30SM070 22BOX85
30SM071 22BOX85
30SM072 22BOX85
30SM073 22BOX85
30SM074 22BOX60
30SM075 22BOX85
30SM076 22BOX85
30SM078 22BOX60
30SM079 22BOX60
30SM080 22BOX60
30SM081 22BOX60

SILICONE IDEA BOX
Cod. Cod.

30SM082 22BOX60
30SM083 22BOX60
30SM085 22BOX60
30SM087 22BOX85
30SMA001 MSCS20125
30SMA002 MSCS20125
30SMA003 MSCS20125
30SMA004 MSCS20125
30SMA005 MSCS20125
30SMA006 MSCS20125
30SMA007 22BOX60
30SMA008 22BOX60
30SMA009 MSCS00225
30SMA010 MSCS20125
30SMA011 MSCS20125
30SMA012 MSCS00225
30SMW01 22BOX85
30SMW02 22BOX60



VARIOUS EQUIPMENT

Quadri per ganache
Frames for ganache



cod. **QG3** Mis. esterna 400x400 h3mm Mis. interna 360x360 mm
cod. **QG5** Mis. esterna 400x400 h5mm Mis. interna 360x360 mm

Quadri per ganache
Frames for ganache

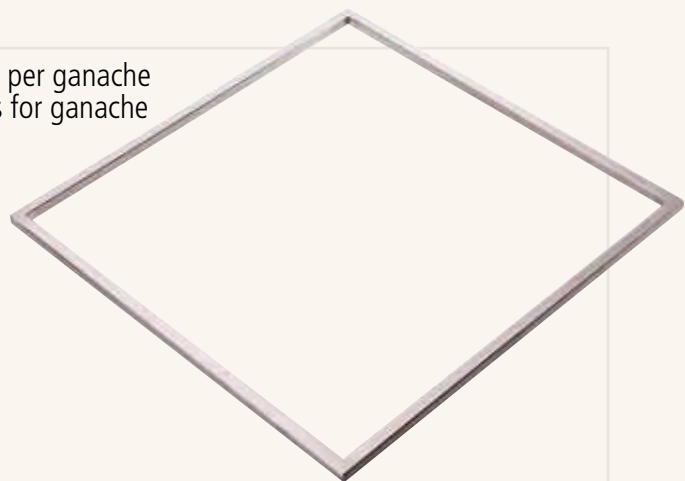

cod. **QG10** Mis. esterna 380x380 h10mm Mis. interna 360x360 mm
cod. **QG15** Mis. esterna 380x380 h15mm Mis. interna 360x360 mm

Forma in gomma per decorazioni di cioccolato.
Rubber mould for chocolate decorations



cod. **GRECA01** 300x100 h10mm

Termometro digitale per cioccolato.
Digital thermometer for chocolate.
Celsius -50 °C / +150 °C
Fahrenheit -58 °F / +302 °F.



cod. **50T001**

Piano in acciaio riscaldato elettricamente per la lavorazione del cioccolato e di altri alimenti.
Struttura in materiale plastico con ripiano inox removibile. Temperatura max 55° C. Disponibile 110 V su richiesta.
Electrical Heating surface for chocolate and other food. Plastic structure with removable st. steel plate.
Temperature max 55° C. Available 110v on demand.

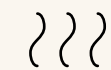

Cod. **PR001**

Misura - Size: 32x40 h11,5cm
230V - 50/60Hz - 0,35A - 80W



Fogli in silicone per la produzione di decorazioni in cioccolato.
 Misura 39x29cm - Spessore 1,5mm.
 Silicone sheets for chocolate decorations. Size 39x29cm
 Thickness 1,5mm.

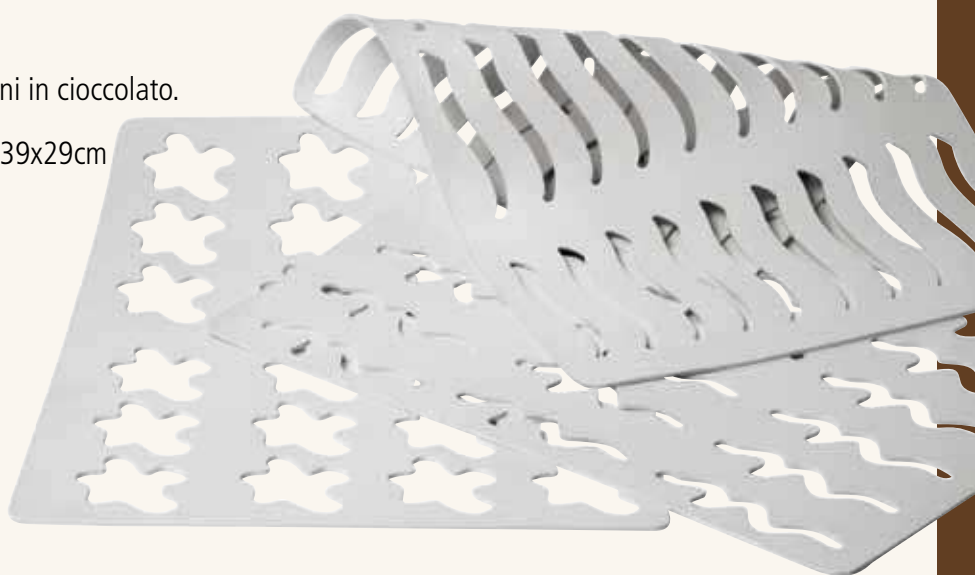

Cod. **CHASIL1**
 35x25 mm
 60 pcs



Cod. **CHASIL2**
 35x33 mm
 48 pcs



Cod. **CHASIL3**
 35x25 mm
 48 pcs



Cod. **CHASIL4**
 60x53 mm
 20 pcs



Cod. **CHASIL5**
 50x78 mm
 18 pcs



Cod. **CHASIL6**
 58x48 mm
 25 pcs



Cod. **CHASIL7**
 57x50 mm
 24 pcs



Cod. **CHASIL8**
 55x50 mm
 25 pcs



Cod. **CHASIL9**
 102x27 mm
 18 pcs



Cod. **CHASIL10**
 97x30 mm
 18 pcs



Cod. **CHASIL11**
 102x27 mm
 24 pcs



Cod. **CHASIL12**
 102x18 mm
 30 pcs



Cod. **CHASIL13**
 104x26 mm
 24 pcs



Cod. **CHASIL14**
 99x37 mm
 24 pcs



Cod. **CHASIL15**
 82x42 mm
 24 pcs



Cod. **CHASIL16**
 Ø26 mm
 48 pcs



Cod. **CHASIL17**
 Ø36 mm
 36 pcs



Cod. **CHASIL18**
 Ø42 mm
 30 pcs

Set 10 forchette in filo di acciaio inox con manico in plastica.
10 steel forks set with plastic handle.



cod. **CHOCOFORK** Set 10 pcs

Acquistabili anche separatamente.
also purchasable separately.

1 cod. **CHOC0101** 2 rebbi / 2 tines
2 cod. **CHOC0102** 3 rebbi / 3 tines
3 cod. **CHOC0103** 4 rebbi / 4 tines
4 cod. **CHOC0104** spirale / spiral
5 cod. **CHOC0110** goccia / drop

6 cod. **CHOC0106** Ø20mm
7 cod. **CHOC0107** Ø18mm
8 cod. **CHOC0105** Ø16mm
9 cod. **CHOC0108** Ø14mm
10 cod. **CHOC0109** triangolo / triangle

Raschie per cioccolato
Scrapers for chocolate



cod. **RC115** 120x115 mm

Raschie per cioccolato
Scrapers for chocolate



cod. **RC110** 120x110 mm

Piastre con piedini
Grates with feet



cod. **PR30** Ø30 cm
cod. **PR40** Ø40 cm

Piastre con piedini
Grates with feet

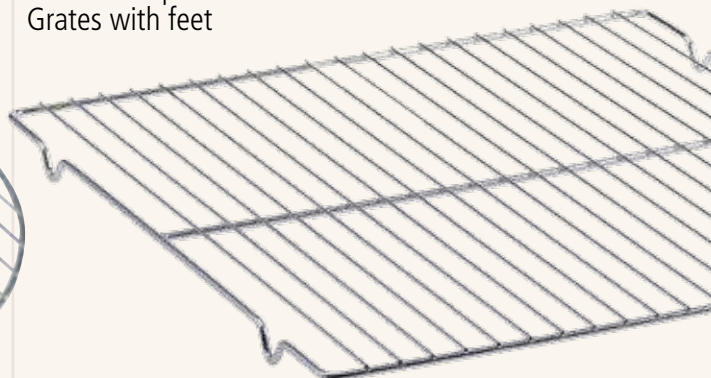

cod. **PR30X30** 30x30 cm
cod. **PR40X60** 40x60 cm
cod. **PR50X50** 50x50 cm

Kit 13 fogli in plastica trasparente per la realizzazione di decorazioni di cioccolato in rilievo, fantasie varie.
 13 transparent plastic sheets kit for the production of chocolate decorations in relief, different patterns.

cod. **MACL01** 360x340 mm



Lastre in plastica trasparente per realizzare decorazioni di cioccolato in rilievo. Spessore 4,5mm.
 Transparent plastic sheets for relief chocolate decorations. Thickness 4,5mm.



cod. **LPR1** 50x40 cm



cod. **LPR2** 50x40 cm



cod. **LPR3** 50x40 cm



cod. **LPR4** 50x40 cm

SEMIFREDDO MATS



I nuovi tappeti in silicone per semifreddo sapranno arricchire i vostri tronchetti.

Le ormai note caratteristiche di questo materiale rendono possibile un'ottimale sformatura del semifreddo donando al dessert decori di grande effetto.

The new silicone mats for semifreddos will enrich your log-shaped dessert.

The well-known features of this material ensure easy removal of the semifreddo from the mould, creating impressive decorations.

Semifreddo Mats

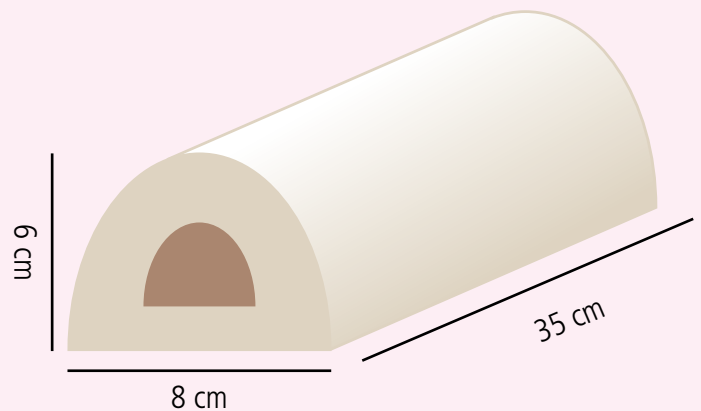

HOW TO USE

1 - Spatolare il composto prima di adagiare il tappeto nella teglia.

2 - Inserire il tappeto in silicone nell'apposita sede.

3 - Riempire lo stampo con il semifreddo e se previsto, e adagiare l'insero precedentemente abbattuto.

4 - Chiudere con il biscuit e mettere in abbattitore.

5 - Estrarre dall'alveolo il tronco aiutandosi con una piccola spatola o un cutter.

6 - Togliere con cura il tappeto in silicone dal semifreddo e decorare a piacere.

1 - Mixture with a spatula before placing the mat in the mould.

2 - Insert the silicone mat in its place.

3 - Fill the mould with the semifreddo and if provided, place the insert previously frozen.

4 - Close with the biscuit and put in a blast chiller.

5 - Pull out the log with the help of a small spatula or a cutter.

6 - Carefully remove the silicone mat from the semifreddo and decorate as desired.

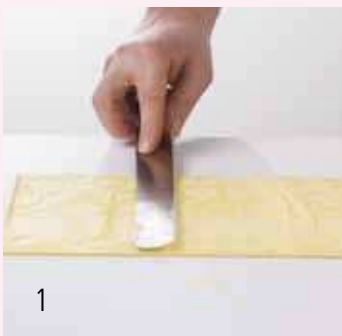



Arabic

Cod. **30TS001**
Tappeto silicone texture
Silicone mat texture
tappeto 36x16 cm
mat 36x16 cm



Floreal

Cod. **30TS002**
Tappeto silicone texture
Silicone mat texture
tappeto 36x16 cm
mat 36x16 cm



O'Clock

Cod. **30TS003**
Tappeto silicone texture
Silicone mat texture
tappeto 36x16 cm
mat 36x16 cm



Flower

Cod. **30TS004**
Tappeto silicone texture
Silicone mat texture
tappeto 36x16 cm
mat 36x16 cm



Medieval

Cod. **30TS005**
Tappeto silicone texture
Silicone mat texture
tappeto 36x16 cm
mat 36x16 cm



Stone

Cod. **30TS006**
Tappeto silicone texture
Silicone mat texture
tappeto 36x16 cm
mat 36x16 cm



Waves

Cod. **30TS007**
Tappeto silicone texture
Silicone mat texture
tappeto 36x16 cm
mat 36x16 cm

Cod. **30T604007**
tappeto 59x39 cm
mat 59x39 cm



Holly

Cod. **30TS008**
Tappeto silicone texture
Silicone mat texture
tappeto 36x16 cm
mat 36x16 cm



Snowflake

Cod. **30TS009**
Tappeto silicone texture
Silicone mat texture
tappeto 36x16 cm
mat 36x16 cm



Comet

Cod. **30TS010**
Tappeto silicone texture
Silicone mat texture
tappeto 36x16 cm
mat 36x16 cm



Tronco

Cod. **30TS011**
Tappeto silicone texture
Silicone mat texture
tappeto 36x16 cm
mat 36x16 cm



Regular Brick

Cod. **30TS012**
Tappeto silicone texture
Silicone mat texture
tappeto 36x16 cm
mat 36x16 cm

Cod. **30T604011**
tappeto 59x39 cm
mat 59x39 cm

Cod. **30T604012**
tappeto 59x39 cm
mat 59x39 cm



Stella Cometa

Cod. **30TS013**
Tappeto silicone texture
Silicone mat texture
tappeto 36x16 cm
mat 36x16 cm



Farfalle e Fiori

Cod. **30TS014**
Tappeto silicone texture
Silicone mat texture
tappeto 36x16 cm
mat 36x16 cm



Fiorellini

Cod. **30TS015**
Tappeto silicone texture
Silicone mat texture
tappeto 36x16 cm
mat 36x16 cm

Cod. **30T604013**
tappeto 59x39 cm
mat 59x39 cm

Cod. **30T604014**
tappeto 59x39 cm
mat 59x39 cm

Cod. **30T604015**
tappeto 59x39 cm
mat 59x39 cm



Quadri

Cod. **30TS016**
Tappeto silicone texture
Silicone mat texture
tappeto 36x16 cm
mat 36x16 cm



Fiori e Ricci

Cod. **30TS017**
Tappeto silicone texture
Silicone mat texture
tappeto 36x16 cm
mat 36x16 cm



Margherite

Cod. **30TS018**
Tappeto silicone texture
Silicone mat texture
tappeto 36x16 cm
mat 36x16 cm

Cod. **30T604016**
tappeto 59x39 cm
mat 59x39 cm

Cod. **30T604017**
tappeto 59x39 cm
mat 59x39 cm

Cod. **30T604018**
tappeto 59x39 cm
mat 59x39 cm

SEMIFREDDO MATS

Preferisci proporre i semifreddi più classici ma non vuoi rinunciare alle nuove texture? Abbina i tappeti silicone alle fasce inox per realizzare dei semifreddi rettangolari dal decoro raffinato.

Would you like the traditional Semifreddos but you don't want to give up the new textures? Match the silicone mats with the stainless steel bands to make rectangular-shaped semifreddos with a refined decoration.



Cod. **11H4L36**

Fascia inox
st. steel band
36x16,5 h4 cm

Cod. **RETH4**

Fascia inox
st. steel band
38x58 h4 cm

Cod. **11H5L36**

Fascia inox
st. steel band
36x16,5 h5 cm

Cod. **RETH5**

Fascia inox
st. steel band
38x58 h5 cm



Tappetini in silicone - Silicone mats



Arabic

Cod. **30TS001**
Tappeto silicone texture
Silicone mat texture
tappeto 36x16 cm
mat 36x16 cm



Floreal

Cod. **30TS002**
Tappeto silicone texture
Silicone mat texture
tappeto 36x16 cm
mat 36x16 cm



O'Clock

Cod. **30TS003**
Tappeto silicone texture
Silicone mat texture
tappeto 36x16 cm
mat 36x16 cm



Flower

Cod. **30TS004**
Tappeto silicone texture
Silicone mat texture
tappeto 36x16 cm
mat 36x16 cm



Medieval

Cod. **30TS005**
Tappeto silicone texture
Silicone mat texture
tappeto 36x16 cm
mat 36x16 cm



Stone

Cod. **30TS006**
Tappeto silicone texture
Silicone mat texture
tappeto 36x16 cm
mat 36x16 cm



Waves

Cod. **30TS007**
Tappeto silicone texture
Silicone mat texture
tappeto 36x16 cm
mat 36x16 cm

Stampi in plastica per decorazioni - Plastic moulds for decorations



Arabic

Cod. **20TES001**
2 Stampi decoro cioccolato
2 Chocolate decoration moulds
Prod. 12 decori



Floreal

Cod. **20TES002**
2 Stampi decoro cioccolato
2 Chocolate decoration moulds
Prod. 12 decori



O'Clock

Cod. **20TES003**
2 Stampi decoro cioccolato
2 Chocolate decoration moulds
Prod. 12 decori



Flower

Cod. **20TES004**
2 Stampi decoro cioccolato
2 Chocolate decoration moulds
Prod. 12 decori



Medieval

Cod. **20TES005**
2 Stampi decoro cioccolato
2 Chocolate decoration moulds
Prod. 12 decori



Stone

Cod. **20TES006**
2 Stampi decoro cioccolato
2 Chocolate decoration moulds
Prod. 12 decori



Waves

Cod. **20TES007**
2 Stampi decoro cioccolato
2 Chocolate decoration moulds
Prod. 12 decori





Holly

Cod. **30TS008**
Tappeto silicone texture
Silicone mat texture
tappeto 36x16 cm
mat 36x16 cm



Snowflake

Cod. **30TS009**
Tappeto silicone texture
Silicone mat texture
tappeto 36x16 cm
mat 36x16 cm



Comet

Cod. **30TS010**
Tappeto silicone texture
Silicone mat texture
tappeto 36x16 cm
mat 36x16 cm



Tronco

Cod. **30TS011**
Tappeto silicone texture
Silicone mat texture
tappeto 36x16 cm
mat 36x16 cm

Cod. **30T604011**
tappeto 59x39 cm
mat 59x39 cm



Regular Brick

Cod. **30TS012**
Tappeto silicone texture
Silicone mat texture
tappeto 36x16 cm
mat 36x16 cm

Cod. **30T604012**
tappeto 59x39 cm
mat 59x39 cm



Stella Cometa

Cod. **30TS013**
Tappeto silicone texture
Silicone mat texture
tappeto 36x16 cm
mat 36x16 cm

Cod. **30T604013**
tappeto 59x39 cm
mat 59x39 cm



Farfalle e Fiori

Cod. **30TS014**
Tappeto silicone texture
Silicone mat texture
tappeto 36x16 cm
mat 36x16 cm

Cod. **30T604014**
tappeto 59x39 cm
mat 59x39 cm



Fiorellini

Cod. **30TS015**
Tappeto silicone texture
Silicone mat texture
tappeto 36x16 cm
mat 36x16 cm

Cod. **30T604015**
tappeto 59x39 cm
mat 59x39 cm



Quadri

Cod. **30TS016**
Tappeto silicone texture
Silicone mat texture
tappeto 36x16 cm
mat 36x16 cm

Cod. **30T604016**
tappeto 59x39 cm
mat 59x39 cm



Fiori e Ricci

Cod. **30TS017**
Tappeto silicone texture
Silicone mat texture
tappeto 36x16 cm
mat 36x16 cm

Cod. **30T604017**
tappeto 59x39 cm
mat 59x39 cm



Margherite

Cod. **30TS018**
Tappeto silicone texture
Silicone mat texture
tappeto 36x16 cm
mat 36x16 cm

Cod. **30T604018**
tappeto 59x39 cm
mat 59x39 cm

Teglie in plastica - Plastic trays



Cod. 30TT302S

Teglia per tronchi 30x40cm
Stampo 2 sedi 8x35,5 h6 cm
Logs tray 30x40cm
2 cavity mould 8x35,5 h6 cm

Cod. 30TT605S

Teglia per tronchi 60x40cm
Stampo 5 sedi 8x35,5 h6 cm
Logs tray 60x40cm
5 cavity mould 8x35,5 h6 cm

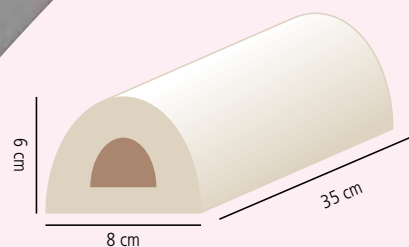

Nastri acetati su misura per tronchi - Acetate sheets for log-shaped dessert

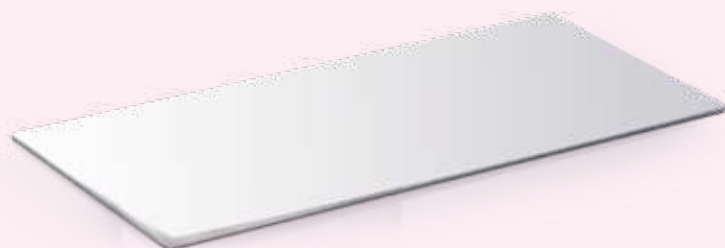

Cod. NSA36X16

FOGLI ACETATO - ACETATE SHEETS
Misura / Size: 360x163mm
Composto da / Contains:
pack 50 fogli / sheets

Cod. NSA CM 60X40

FOGLI ACETATO - ACETATE SHEETS
Misura / Size: 600x400mm
Composto da / Contains:
pack 50 fogli / sheets

Stampi per inserti tronco - Log inserts moulds

Ideali per tappeto tronco 36x16cm
Ideal for log mat 36x16cm



Cod. 30TB3S

Kit 2 stampi plastica per inserti.
2 plastic moulds kit for inserts.
35x180 h30 mm

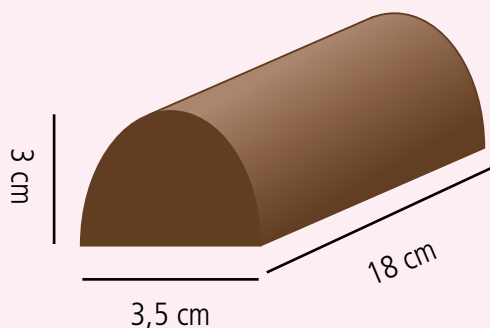

Scegli il tuo Kit per cominciare

Choose your kit to begin



**2 tappetini
mats**

+

**2 stampi decoro
decoration moulds**

+

**1 teglia
tray**

Stampo 2 sedi 8x35,5 h6,5 cm
2 cavity mould 8x35,5 h6,5 cm

kit con decorazione ARABIC

Cod. **30T01K**

Composto da / Contains:

- 1 Teglia per tronchi 30x40cm
Log tray 30x40cm
- 2 Tappeto silicone texture ARABIC
Silicone mat texture ARABIC
- 2 Stampi decoro cioccolato ARABIC
Chocolate decoration moulds ARABIC
Prod. 12 decori



kit con decorazione FLOREAL

Cod. **30T02K**

Composto da / Contains:

- 1 Teglia per tronchi 30x40cm
Log tray 30x40cm
- 2 Tappeto silicone texture FLOREAL
Silicone mat texture FLOREAL
- 2 Stampi decoro cioccolato FLOREAL
Chocolate decoration moulds FLOREAL
Prod. 12 decori

kit con decorazione O'CLOCK

Cod. **30T03K**

Composto da / Contains:

- 1 Teglia per tronchi 30x40cm
Log tray 30x40cm
- 2 Tappeto silicone texture O'CLOCK
Silicone mat texture O'CLOCK
- 2 Stampi decoro cioccolato O'CLOCK
Chocolate decoration moulds O'CLOCK
Prod. 12 decori

kit con decorazione FLOWER

Cod. **30T04K**

Composto da / Contains:

- 1 Teglia per tronchi 30x40cm
Log tray 30x40cm
- 2 Tappeto silicone texture FLOWER
Silicone mat texture FLOWER
- 2 Stampi decoro cioccolato FLOWER
Chocolate decoration moulds FLOWER
Prod. 12 decori

kit con decorazione MEDIIEVAL

Cod. **30T05K**

Composto da / Contains:

- 1 Teglia per tronchi 30x40cm
Log tray 30x40cm
- 2 Tappeto silicone texture MEDIIEVAL
Silicone mat texture MEDIIEVAL
- 2 Stampi decoro cioccolato MEDIIEVAL
Chocolate decoration moulds MEDIIEVAL
Prod. 12 decori

kit con decorazione STONE

Cod. **30T06K**

Composto da / Contains:

- 1 Teglia per tronchi 30x40cm
Log tray 30x40cm
- 2 Tappeto silicone texture STONE
Silicone mat texture STONE
- 2 Stampi decoro cioccolato STONE
Chocolate decoration moulds STONE
Prod. 12 decori

kit con decorazione WAVES

Cod. **30T07K**

Composto da / Contains:

- 1 Teglia per tronchi 30x40cm
Log tray 30x40cm
- 2 Tappeto silicone texture WAVES
Silicone mat texture WAVES
- 2 Stampi decoro cioccolato WAVES
Chocolate decoration moulds WAVES
Prod. 12 decori

CYLINDER-SHAPED SEMIFREDDO MOULDS

Martellato inventa un nuovo sistema per produrre semifreddi a forma di cilindro. Un'inedita concezione che aiuta il pasticcere a presentare dessert di grande effetto e al tempo stesso supporta l'operatore durante il processo produttivo. Un dessert apparentemente complesso ma, grazie allo stampo SEMIFREDDO 360°, facilmente realizzabile.

Martellato invents a new system to prepare cylinder-shaped semifreddos. An original concept that helps the pastry chef to make impressive dessert and at the same time supports the expert during the preparation process. An apparently difficult dessert which is easily achievable thanks to the SEMIFREDDO 360° mould.



semi freddo 360°

HOW TO USE



Cod. **30TC001K**

STARTER KIT

Composto da / Contains:

- 2 Stampi cilindro - Cylinder moulds
Ø 85 h 200 mm
(inclusi 2 tappi gialli - including 2 yellow stoppers)
- 1 Estrattore - Extractor
- 4 Stampi in silicone per realizzare gli inserti
Silicone moulds to create insert
(inclusa teglia di supporto - pan included)
- 10 fogli di acetato
acetate sheets



Lo Starter Kit è composto da due stampi in plastica a forma di cilindro, due tappi gialli necessari prima per non far fuoriuscire il composto e poi per rendere possibile la sformatura. Inoltre, per agevolare l'estrazione, la confezione include anche dei fogli di acetato trasparente tagliato in misura da adagiare nella parete interna del cilindro e un estrattore di plastica.

The Starter Kit includes two plastic cylinder-shaped moulds, two yellow stoppers that are necessary first not to let the mixture coming out, then to make demoulding possible. Moreover, to facilitate the extraction the package also includes transparent acetate sheets to be put inside the cylinder and a plastic extractor.



Stampi cilindro - Cylinder moulds

Cod. **30TC0016**

Composto da / Contains:

6 Stampi cilindro - Cylinder moulds
Ø 85 h 200 mm
(inclusi 6 tappi gialli - including 6 yellow stoppers)

1 Estrattore - Extractor



Fogli decorati - Decorated sheets

Cod. **30TCDECO1K**

SET 8 FOGLI DECORATI PER SEMIFREDDO CILINDRO
8 DECORATED SHEETS FOR CYLINDER SEMIFREDDO
Misura / Size: 200x267mm

Composto da / Contains:

2 fogli SFERE / BALL sheets
2 fogli DUNE / DUNE sheets
2 fogli IMBOTTITURA / PADDING sheets
2 fogli FLOREALE / FLORAL sheets



Nastri acetati - Acetate sheets

Cod. **NSA27X20**

FOGLI DI ACETATO
ACETATE SHEETS
Misura / Size: 200x267mm

Composto da / Contains:
conf. 50 fogli / sheets



Stampi in plastica decorazioni - Plastic mould for decorations

Per arricchire il dessert Martellato propone in abbinata una serie di texture sfere, dune, imbottitura e floreale e degli stampi in plastica per produrre decori di cioccolato in coordinato alla decorazione del semifreddo.

To enrich dessert Martellato provides its customers with some textures (spheres, dunes, padding and floral) and also plastic moulds suitable to produce chocolate decorations which match these semifreddo garnish.

Cod. 20TEC1K

SET 4 STAMPI DECORAZIONI DI CIOCCOLATO
PER SEMIFREDDO CILINDRO
4 DECORATIONS MOULDS FOR CHOCOLATE
SEMIFREDDO CYLINDER

Composto da / Contains:

- 1 Stampo decoro SFERE
Mould for decoration BALL
- 1 Stampo decoro DUNE
Mould for decoration DUNE
- 1 Stampo decoro IMBOTTITURA
Mould for decoration PADDING
- 1 Stampo decoro FLOREALE
Mould for decoration FLORAL



Stampi per inserti - Inserts moulds

Cod. 30TB4S

Kit 4 stampi silicone per inserti con teglia di sostegno in plastica.
4 silicone moulds kit for inserts, with plastic support tray.
Ø30 x194 mm

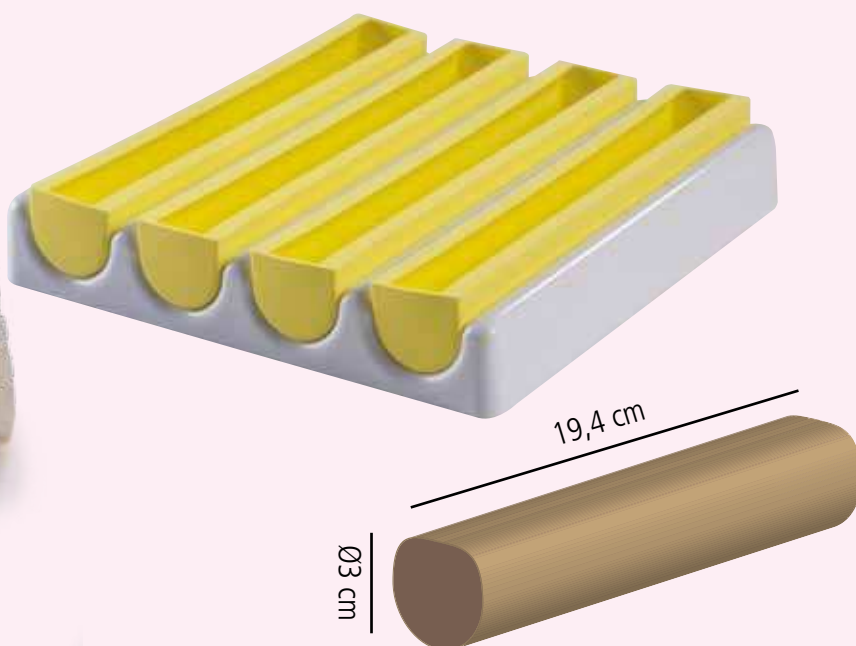

Lo stampo inserto nasce principalmente per la linea Semifreddo 360°, ma si adatta facilmente a qualsiasi altro stampo.

Per facilitare la produzione del pasticcere abbiamo creato un kit che include 4 inserti in silicone e una teglia di sostegno in plastica che misura 19x19cm

The insert mould is mostly suitable for the SEMIFREDDO 360° line but it can be easily adapted to any other mould. To make pastry chef's work easier, the insert mould is available in kit that includes 4 silicone inserts and plastic support with the following dimension 19x19cm



PLASTIC MOULDS

Stampi per tronchi semifreddo.
Log-shaped cakes moulds.



cod. **ST1** 480x65 h 65mm



cod. **ST2** 480x65 h 50mm
ST4 480x50 h 40mm



cod. **ST3** 480x65 h 50mm



cod. **STN1** 480x65 h 65mm



cod. **STN2** 480x65 h 50mm



cod. **STN3** 480x65 h 50mm



cod. **ST7** 230x90 h 70mm



cod. **ST8** 370x90 h 70mm



cod. **ST9** 250x100 h 70mm



cod. **RKS 10** Ø75 h 50 mm 10 pcs
 cod. **RKS 20** Ø75 h 50 mm 20 pcs



cod. **SKB 10** Ø65 h 60 mm 10 pcs
 cod. **SKB 20** Ø65 h 60 mm 20 pcs

Set di quattro stampi in plastica.
 Set of four plastic moulds.



cod. **TPSET4**
 60x80 h30 - 105x75 h40
 150x120 h51 - 205x150 h67 mm



cod. **SF 3** Ø 140 - Ø 160 - Ø 180 mm

ACETATE RIBBON

Rotolo - Roll

90my



cod. **NSA H 25** h25mm 305 mt
 cod. **NSA H 30** h30mm 305 mt
 cod. **NSA H 35** h35mm 305 mt
 cod. **NSA H 40** h40mm 305 mt
 cod. **NSA H 45** h45mm 305 mt
 cod. **NSA H 50** h50mm 305 mt
 cod. **NSA H 55** h55mm 305 mt
 cod. **NSA H 60** h60mm 305 mt

Pretagliato - Precut

90my



cod. **NSA 40X240** 40x240mm 1000 pcs
 cod. **NSA 30X240** 30x240mm 1000 pcs
 cod. **NSA 25X150** 25x150mm 1000 pcs

Fogli - Sheets

90my



cod. **NSA27X20** 200x267mm 50 pcs
 cod. **NSA36X16** 360x163mm 50 pcs
 cod. **NSACM30X30** 300x300mm 50 pcs
 cod. **NSA CM 60X40** 600x400mm 50 pcs

SEMIFREDDO MOULDS



Lo stampo Martellato è realizzato in materiale plastico resistente ma allo stesso tempo sufficientemente flessibile per permettere una facile estrazione. Per garantire un buon risultato Martellato consiglia di scuotere lo stampo, una volta riempito, per compatte il contenuto ed eliminare la possibile formazione di bolle d'aria. Congelare il semifreddo, in abbattitore o freezer, fino a -20°C al cuore.

Conf. 2 pezzi, stesso modello, formato piccolo e grande.

Martellato moulds are made of durable plastic, but at the same time sufficiently flexible to allow easy extraction. To ensure a good result Martellato recommends to shake the mould, once filled, in order to tamp down its content and eliminate the possible formation of air bubbles. Freeze the semifreddo in the blast chiller or freezer, reaching -20°C in the heart of the cake.

Pack 2 pcs, big and small size of the same shape.

HOW TO USE



CONSIGLI PER L'ESTRAZIONE:

Lasciare per qualche minuto il semifreddo a temperatura ambiente.

6 - Per facilitare la sformatura immergere lo stampo in acqua non calda o passare un panno facendo attenzione a non riscaldare troppo il semifreddo.

8 - Dopo l'estrazione decorare con la linea coloranti spray Velvet.

SUGGESTIONS FOR DEMOULDING:

Leave the semifreddo at room temperature for a few minutes.

6 - To make demoulding easier, put the mould in a basin with water or use a soft cloth, paying attention not to warm the semifreddo too much.

8 - Decorate it with the Velvet spray colourings.





Cod. **SS001**
Misura - Size:
243x123 h35mm
196x117 h40mm

Cod. **SS002**
Misura - Size:
237x126 h60mm
180x110 h50mm



Cod. **SS003**
Misura - Size:
243x116 h50mm
204x105 h45mm

Cod. **SS004**
Misura - Size:
255x110 h46mm
205x104 h45mm

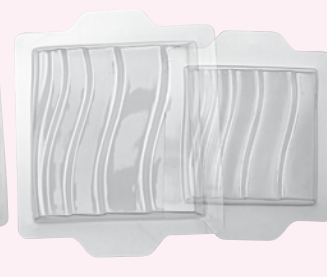

Cod. **SS005**
Misura - Size:
197x197 h60mm
160x160 h40mm

Cod. **SS006**
Misura - Size:
194x194 h45mm
157x157 h35mm



Cod. **SS007**
Misura - Size:
197x197 h55mm
157x157 h45mm



Cod. **SS008**
Misura - Size:
225x200 h50mm
175x185 h43mm



Cod. **SS009**
Misura - Size:
200x200 h40mm
160x160 h38mm



Cod. **SS010**
Misura - Size:
200x200 h70mm
160x160 h60mm



Cod. **SS011**
Misura - Size:
204x204 h35mm
163x163 h40mm



Cod. **SS012**
Misura - Size:
Ø200 h65mm
Ø155 h60mm



Cod. **SS013**
Misura - Size:
Ø205 h45mm
Ø165 h40mm



Cod. **SS014**
Misura - Size:
Ø195 h55mm
Ø160 h55mm



Cod. **SS015**
Misura - Size:
Ø210 h40mm
Ø160 h45mm



Cod. **SS016**
Misura - Size:
Ø220 h55mm
Ø170 h50mm



Cod. **SS017**
Misura - Size:
Ø200 h60mm
Ø165 h60mm



Cod. **SS018**
Misura - Size:
Ø205 h55mm
Ø160 h50mm



Cod. **SS019**
Misura - Size:
Ø195 h60mm
Ø160 h55mm



Cod. **SS020**
Misura - Size:
Ø195 h50mm
Ø160 h40mm



Cod. **SS021**
Misura - Size:
Ø195 h60mm
Ø155 h55mm



Cod. **SS022**
Misura - Size:
185x185 h50mm
150x150 h45mm



Cod. **SS023**
Misura - Size:
190x190 h50mm
150x150 h45mm



Cod. **SS024**
Misura - Size:
250x136 h72mm
180x98 h52mm



Cod. **SS025**
Misura - Size:
245x130 h63mm
178x96 h42mm



Cod. **SS026**
Misura - Size:
262x105 h69mm
190x76 h52mm



Cod. **SS027**
Misura - Size:
248x153 h68mm
180x111 h50mm



Cod. **SS028**
Misura - Size:
250x128 h70mm
180x93 h52mm



Cod. **SS029**
Misura - Size:
248x134 h70mm
178x97 h52mm



Cod. **SS030**
Misura - Size:
236x126 h70mm
172x92 h50mm



Cod. **SS031**
Misura - Size:
248x146 h68mm
178x105 h50mm



Cod. **SS032**
Misura - Size:
225x182 h74mm
177x144 h55mm



Cod. **SS033**
Misura - Size:
250x115 h70mm
185x86 h52mm



Cod. **SS034**
Misura - Size:
250x116 h70mm
180x84 h50mm



Cod. **SS035**
Misura - Size:
235x98 h70mm
180x87 h50mm



Cod. **SS036**
Misura - Size:
245x100 h71mm
180x73 h50mm



Cod. **SS037**
Misura - Size:
250x95 h62mm
180x68 h52mm



Cod. **SS038**
Misura - Size:
250x98 h70mm
180x70 h50mm

SINGLE-SERVING MOULDS

Martellato offre un'ampia gamma di stampi per semifreddo di varie dimensioni e dalle più svariate forme. Modelli dal design moderno che garantiscono un raffinato risultato e conferiscono al dessert un tocco di assoluta originalità.

Congelare il semifreddo, in abbattitore o freezer, fino a -20°C al cuore.

Blister conf. 3 pezzi. Produttività 12 semifreddi
Grammatura indicativa 130-150gr

Martellato provides its customers with a wide range of semifreddo moulds of various sizes and shapes. Modern design models that provide a stylish result and give dessert a touch of absolute originality.

Freeze the semifreddo in the blast chiller or freezer, reaching -20°C in the heart of the cake.

Blister pack 3 pcs. Productivity 12 semifreddo
Approximately 130-150 gr



3x4 Produttività
Capacity **12**



Cod. **SSM024/3**

Misura - Size:
110x62 h33mm



Cod. **SSM025/3**

Misura - Size:
110x57 h30mm



Cod. **SSM026/3**

Misura - Size:
120x48 h32mm



Cod. **SSM027/3**

Misura - Size:
118x74 h30mm



Cod. **SSM028/3**

Misura - Size:
110x57 h32mm



Cod. **SSM029/3**

Misura - Size:
110x60 h33mm

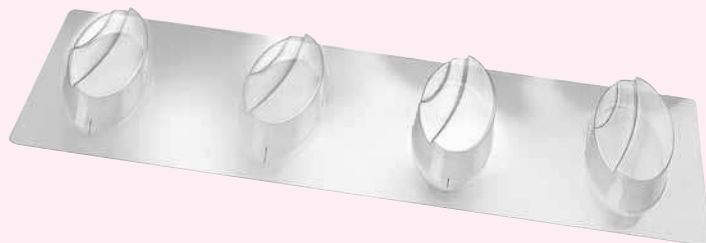

Cod. **SSM030/3**

Misura - Size:
103x55 h30mm



Cod. **SSM031/3**

Misura - Size:
110x65 h32mm



Cod. **SSM032/3**

Misura - Size:
118x95 h35mm



Cod. **SSM033/3**

Misura - Size:
120x60 h30mm

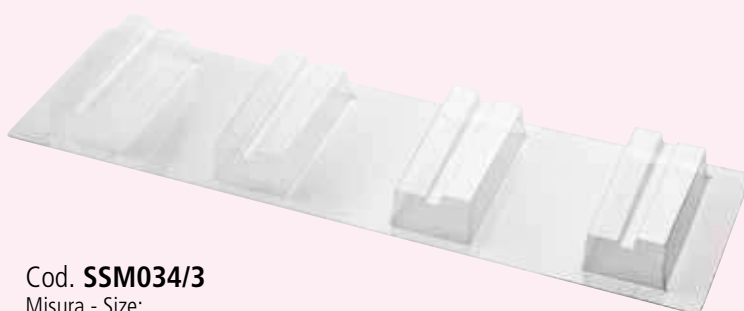

Cod. **SSM034/3**

Misura - Size:
111x52 h33mm

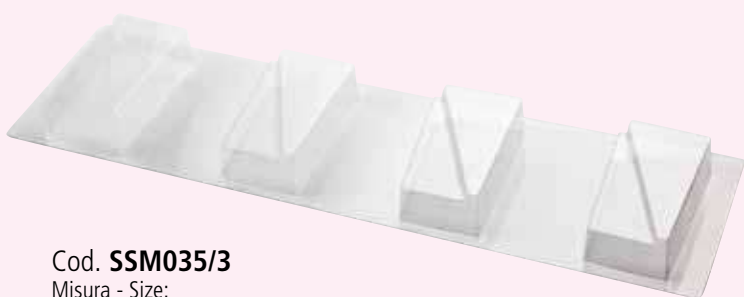

Cod. **SSM035/3**

Misura - Size:
110x54 h30mm



Cod. **SSM036/3**

Misura - Size:
110x44 h32mm

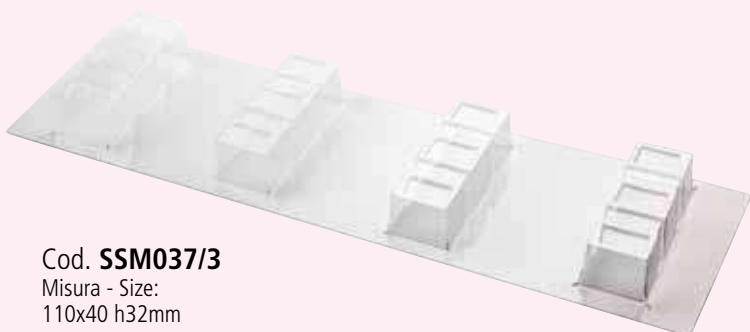

Cod. **SSM037/3**

Misura - Size:
110x40 h32mm

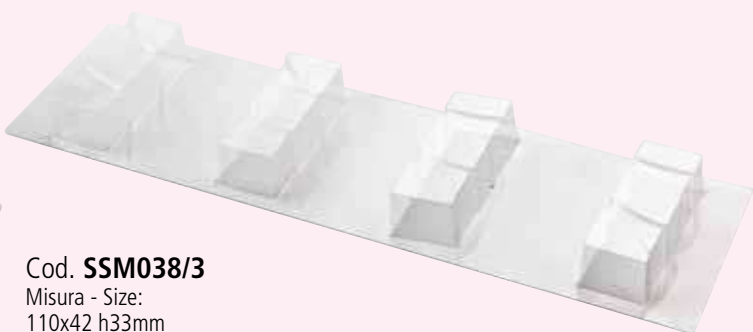

Cod. **SSM038/3**

Misura - Size:
110x42 h33mm

SINGLE-SERVING PLASTIC TRAYS



L'articolo include vassoio e barre:

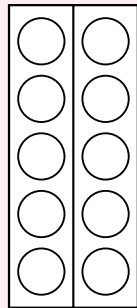

MONOP. A

17x40cm

2 Barre/Moulds

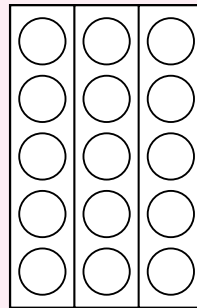

MONOP. B

26x40cm

3 Barre/Moulds

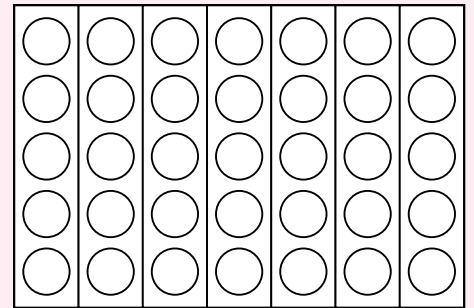

MONOP. C

60x40cm

7 Barre/Moulds

Estrattori e i tagliapasta devono essere ordinati separatamente.
Extractors and cutters must be ordered separately.

Disponibili anche solo i vassoi
Plastic trays only available

Estrattore
Extractor



Tagliapasta
Cutter

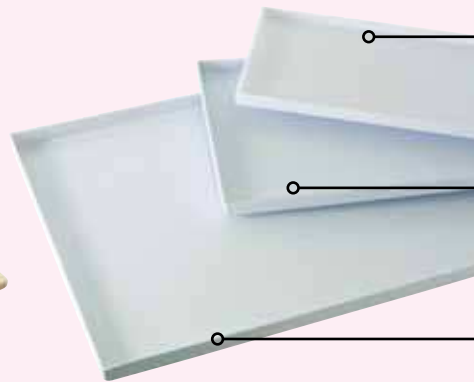

Vassoio per MONOP. A

TRAY FOR MONOP. A

cod. **VASSOIOAMO**

17x40

Misura - Size: 397x176 h 19 mm

Vassoio per MONOP. B

TRAY FOR MONOP. B

cod. **VASSOIOBMO**

26x40

Misura - Size: 396x259 h 20 mm

Vassoio per MONOP. C

TRAY FOR MONOP. C

cod. **VASSOIOCMO**

60x40

Misura - Size: 598x397 h 20 mm

HOW TO USE

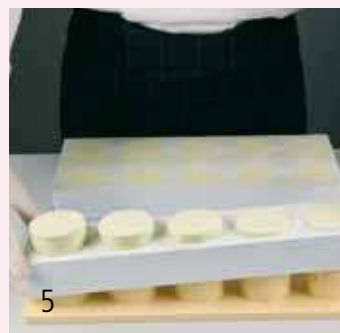
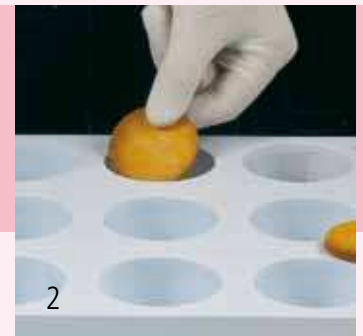

Forma Monoporzione
Single-serving shape

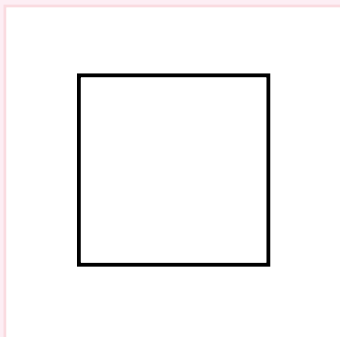
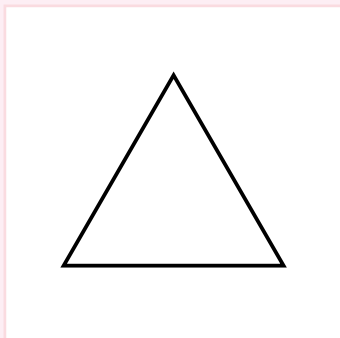
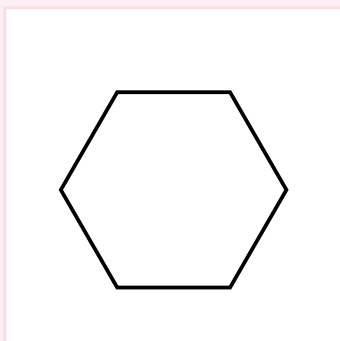
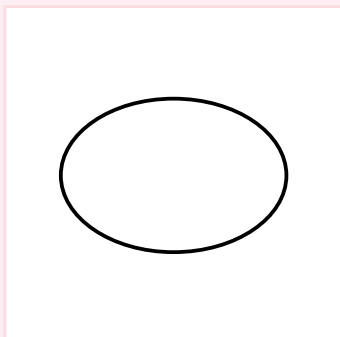
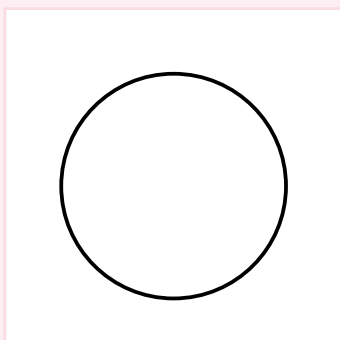

cod.	Misure Size	Volume Volume	Estrattore Extractor	Tagliapasta Cutter	Produttività Capacity	Teglia Tray
MONOP. A001	Ø65 - h40mm	75 gr	EM 1	TPG 1	10	Teglia Tray 17x40
MONOP. A01	Ø65 - h30mm	55 gr	EM 1	TPG 1		
MONOP. A1	Ø60 - h45mm	75 gr	EM 01	TPG 01		
MONOP. B001	Ø65 - h40mm	75 gr	EM 1	TPG 1	15	Teglia Tray 26x40
MONOP. B01	Ø65 - h30mm	55 gr	EM 1	TPG 1		
MONOP. B1	Ø60 - h45mm	75 gr	EM 01	TPG 01		
MONOP. C001	Ø65 - h40mm	75 gr	EM 1	TPG 1	35	Teglia Tray 60x40
MONOP. C01	Ø65 - h30mm	55 gr	EM 1	TPG 1		
MONOP. C1	Ø60 - h45mm	75 gr	EM 01	TPG 01		
MONOP. A002	Ø65 - h40mm	75 gr	EM 2	TPG 2	10	Teglia Tray 17x40
MONOP. A02	Ø65 - h30mm	55 gr	EM 2	TPG 2		
MONOP. A2	Ø60 - h45mm	75 gr	EM 02	TPG 02		
MONOP. B002	Ø65 - h40mm	75 gr	EM 2	TPG 2	15	Teglia Tray 26x40
MONOP. B02	Ø65 - h30mm	55 gr	EM 2	TPG 2		
MONOP. B2	Ø60 - h45mm	75 gr	EM 02	TPG 02		
MONOP. C002	Ø65 - h40mm	75 gr	EM 2	TPG 2	35	Teglia Tray 60x40
MONOP. C02	Ø65 - h30mm	55 gr	EM 2	TPG 2		
MONOP. C2	Ø60 - h45mm	75 gr	EM 02	TPG 02		
MONOP. A003	Ø65 - h40mm	75 gr	EM 3	TPG 3	10	Teglia Tray 17x40
MONOP. A03	Ø65 - h30mm	55 gr	EM 3	TPG 3		
MONOP. A3	Ø60 - h45mm	75 gr	EM 03	TPG 03		
MONOP. B003	Ø65 - h40mm	75 gr	EM 3	TPG 3	15	Teglia Tray 26x40
MONOP. B03	Ø65 - h30mm	55 gr	EM 3	TPG 3		
MONOP. B3	Ø60 - h45mm	75 gr	EM 03	TPG 03		
MONOP. C003	Ø65 - h40mm	75 gr	EM 3	TPG 3	35	Teglia Tray 60x40
MONOP. C03	Ø65 - h30mm	55 gr	EM 3	TPG 3		
MONOP. C3	Ø60 - h45mm	75 gr	EM 03	TPG 03		
MONOP. A004	Ø65 - h40mm	75 gr	EM 4	TPG 4	10	Teglia Tray 17x40
MONOP. A04	Ø65 - h30mm	55 gr	EM 4	TPG 4		
MONOP. B004	Ø65 - h40mm	75 gr	EM 4	TPG 4	15	Teglia Tray 26x40
MONOP. B04	Ø65 - h30mm	55 gr	EM 4	TPG 4		
MONOP. C004	Ø65 - h40mm	75 gr	EM 4	TPG 4	35	Teglia Tray 60x40
MONOP. C04	Ø65 - h30mm	55 gr	EM 4	TPG 4		
MONOP. A005	Ø65 - h40mm	75 gr	EM 5	TPG 5	10	Teglia Tray 17x40
MONOP. A05	Ø65 - h30mm	55 gr	EM 5	TPG 5		
MONOP. B005	Ø65 - h40mm	75 gr	EM 5	TPG 5	15	Teglia Tray 26x40
MONOP. B05	Ø65 - h30mm	55 gr	EM 5	TPG 5		
MONOP. C005	Ø65 - h40mm	75 gr	EM 5	TPG 5	35	Teglia Tray 60x40
MONOP. C05	Ø65 - h30mm	55 gr	EM 5	TPG 5		

Forma Monoporzione
Single-serving shape

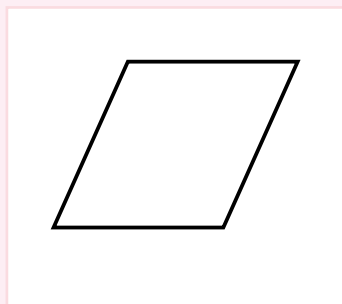

cod.	Misure Size	Volume Volume	Estrattore Extractor	Tagliapasta Cutter	Produttività Capacity	Teglia Tray
MONOP. A006	Ø65 - h40mm	75 gr	EM 6	TPG 6	10	17x40
MONOP. A06	Ø65 - h30mm	55 gr	EM 6	TPG 6		
MONOP. B006	Ø65 - h40mm	75 gr	EM 6	TPG 6	15	26x40
MONOP. B06	Ø65 - h30mm	55 gr	EM 6	TPG 6		
MONOP. C006	Ø65 - h40mm	75 gr	EM 6	TPG 6	35	60x40
MONOP. C06	Ø65 - h30mm	55 gr	EM 6	TPG 6		

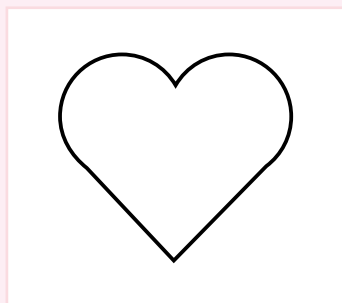

MONOP. A007	Ø65 - h40mm	75 gr	EM 7	TPG 7	10	17x40
MONOP. A07	Ø65 - h30mm	55 gr	EM 7	TPG 7		
MONOP. B007	Ø65 - h40mm	75 gr	EM 7	TPG 7	15	26x40
MONOP. B07	Ø65 - h30mm	55 gr	EM 7	TPG 7		
MONOP. C007	Ø65 - h40mm	75 gr	EM 7	TPG 7	35	60x40
MONOP. C07	Ø65 - h30mm	55 gr	EM 7	TPG 7		

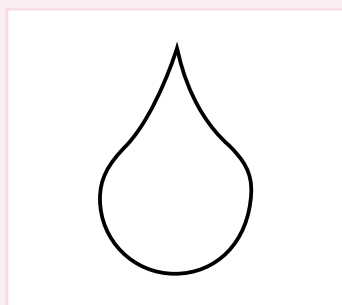

MONOP. A008	Ø65 - h40mm	75 gr	EM 8	TPG 8	10	17x40
MONOP. A08	Ø65 - h30mm	55 gr	EM 8	TPG 8		
MONOP. B008	Ø65 - h40mm	75 gr	EM 8	TPG 8	15	26x40
MONOP. B08	Ø65 - h30mm	55 gr	EM 8	TPG 8		
MONOP. C008	Ø65 - h40mm	75 gr	EM 8	TPG 8	35	60x40
MONOP. C08	Ø65 - h30mm	55 gr	EM 8	TPG 8		

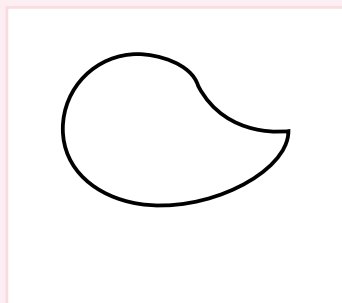

MONOP. A009	Ø65 - h40mm	75 gr	EM 9	TPG 9	10	17x40
MONOP. A09	Ø65 - h30mm	55 gr	EM 9	TPG 9		
MONOP. B009	Ø65 - h40mm	75 gr	EM 9	TPG 9	15	26x40
MONOP. B09	Ø65 - h30mm	55 gr	EM 9	TPG 9		
MONOP. C009	Ø65 - h40mm	75 gr	EM 9	TPG 9	35	60x40
MONOP. C09	Ø65 - h30mm	55 gr	EM 9	TPG 9		

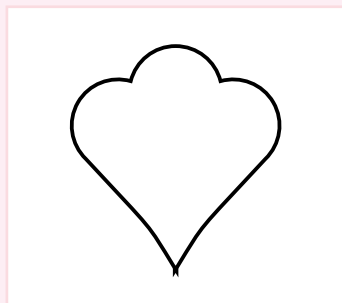

MONOP. A0010	Ø65 - h40mm	75 gr	EM 10	TPG 10	10	17x40
MONOP. A010	Ø65 - h30mm	55 gr	EM 10	TPG 10		
MONOP. B0010	Ø65 - h40mm	75 gr	EM 10	TPG 10	15	26x40
MONOP. B010	Ø65 - h30mm	55 gr	EM 10	TPG 10		
MONOP. C0010	Ø65 - h40mm	75 gr	EM 10	TPG 10	35	60x40
MONOP. C010	Ø65 - h30mm	55 gr	EM 10	TPG 10		

Forma Monoporzione
Single-serving shape

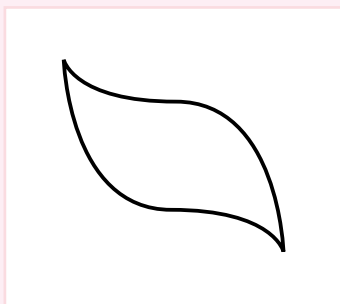

cod.	Misure Size	Volume Volume	Estrattore Extractor	Tagliapasta Cutter	Produttività Capacity		Teglia Tray
MONOP. A0011	Ø65 - h40mm	75 gr	EM 11	TPG 11	10	Teglia	17x40
MONOP. A011	Ø65 - h30mm	55 gr	EM 11	TPG 11			
MONOP. B0011	Ø65 - h40mm	75 gr	EM 11	TPG 11	15	Teglia	26x40
MONOP. B011	Ø65 - h30mm	55 gr	EM 11	TPG 11			
MONOP. C0011	Ø65 - h40mm	75 gr	EM 11	TPG 11	35	Teglia	60x40
MONOP. C011	Ø65 - h30mm	55 gr	EM 11	TPG 11			

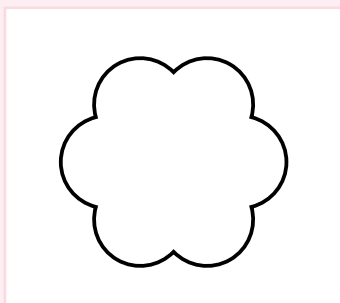

MONOP. A0012	Ø65 - h40mm	75 gr	EM 12	TPG 12	10	Teglia	17x40
MONOP. A012	Ø65 - h30mm	55 gr	EM 12	TPG 12			
MONOP. B0012	Ø65 - h40mm	75 gr	EM 12	TPG 12	15	Teglia	26x40
MONOP. B012	Ø65 - h30mm	55 gr	EM 12	TPG 12			
MONOP. C0012	Ø65 - h40mm	75 gr	EM 12	TPG 12	35	Teglia	60x40
MONOP. C012	Ø65 - h30mm	55 gr	EM 12	TPG 12			

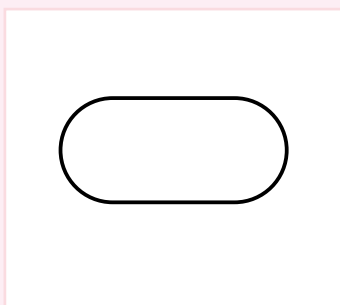

MONOP. A0013	Ø65 - h40mm	75 gr	EM 13	TPG 13	10	Teglia	17x40
MONOP. A013	Ø65 - h30mm	55 gr	EM 13	TPG 13			
MONOP. B0013	Ø65 - h40mm	75 gr	EM 13	TPG 13	15	Teglia	26x40
MONOP. B013	Ø65 - h30mm	55 gr	EM 13	TPG 13			
MONOP. C0013	Ø65 - h40mm	75 gr	EM 13	TPG 13	35	Teglia	60x40
MONOP. C013	Ø65 - h30mm	55 gr	EM 13	TPG 13			

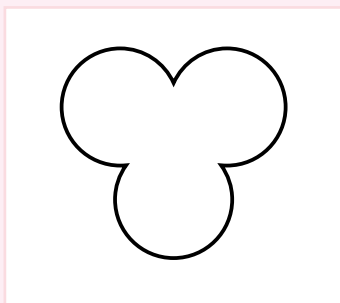

MONOP. A0014	Ø65 - h40mm	75 gr	EM 14	TPG 14	10	Teglia	17x40
MONOP. A014	Ø65 - h30mm	55 gr	EM 14	TPG 14			
MONOP. B0014	Ø65 - h40mm	75 gr	EM 14	TPG 14	15	Teglia	26x40
MONOP. B014	Ø65 - h30mm	55 gr	EM 14	TPG 14			
MONOP. C0014	Ø65 - h40mm	75 gr	EM 14	TPG 14	35	Teglia	60x40
MONOP. C014	Ø65 - h30mm	55 gr	EM 14	TPG 14			

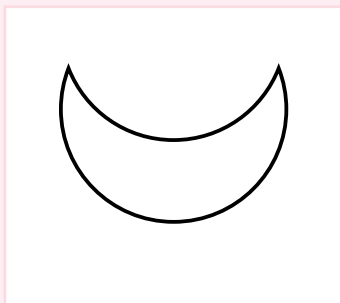

MONOP. A0015	Ø65 - h40mm	75 gr	EM 15	TPG 15	10	Teglia	17x40
MONOP. A015	Ø65 - h30mm	55 gr	EM 15	TPG 15			
MONOP. B0015	Ø65 - h40mm	75 gr	EM 15	TPG 15	15	Teglia	26x40
MONOP. B015	Ø65 - h30mm	55 gr	EM 15	TPG 15			
MONOP. C0015	Ø65 - h40mm	75 gr	EM 15	TPG 15	35	Teglia	60x40
MONOP. C015	Ø65 - h30mm	55 gr	EM 15	TPG 15			

MIGNON MOULDS PLASTIC TRAYS

L'articolo include
vassoio e barre:

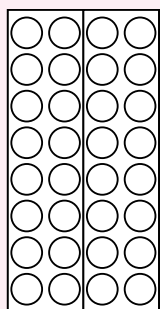
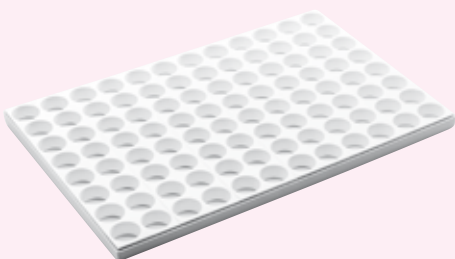

MIGNON A

20x40cm

2 Barre/Moulds

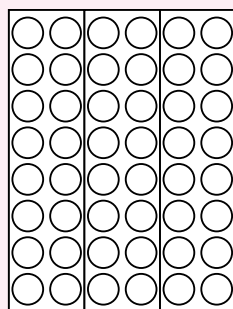

MIGNON B

30x40cm

3 Barre/Moulds

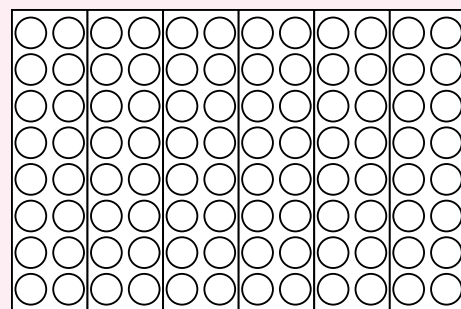

MIGNON C

60x40cm

6 Barre/Moulds

Estrattori e tagliapasta devono
essere ordinati separatamente.
Extractors and cutters
must be ordered separately.

Disponibili anche solo i vassoi
Plastic trays only available

Estrattore
Extractor



Tagliapasta
Cutter

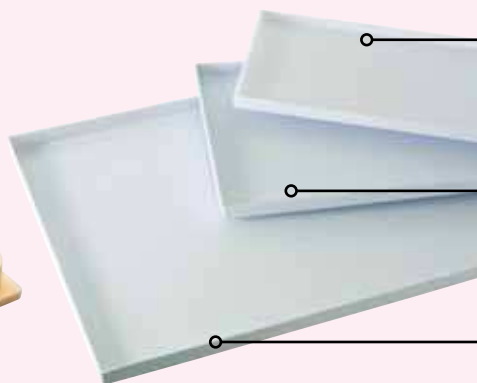

Vassoio per MIGNON. A

TRAY FOR MIGNON. A
cod. **VASSOIOAMI** **20x40**
Misura - Size: 396x201 h 18 mm

Vassoio per MIGNON. B

TRAY FOR MIGNON. B
cod. **VASSOIOBMI** **30x40**
Misura - Size: 396x297 h 20 mm

Vassoio per MIGNON. C

TRAY FOR MIGNON. C
cod. **VASSOIOCMI** **59x39**
Misura - Size: 590x397 h 20 mm



Forma Mignon
Mignon shape

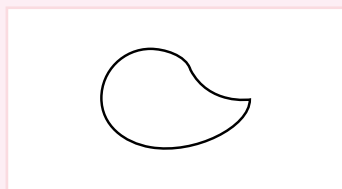
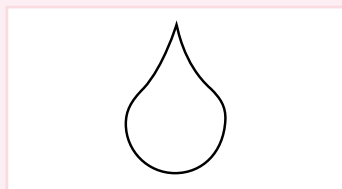
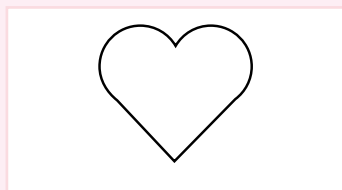
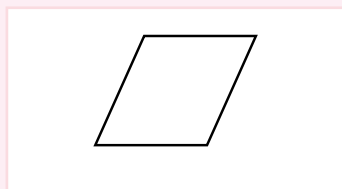
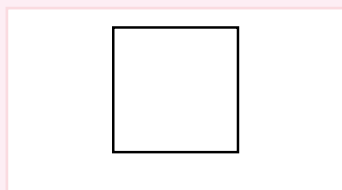
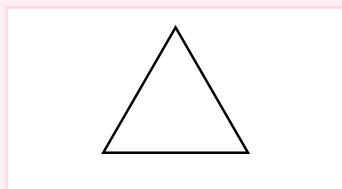
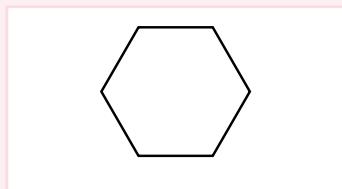
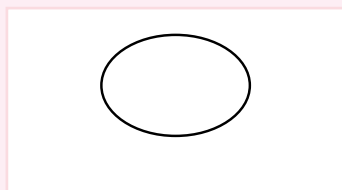
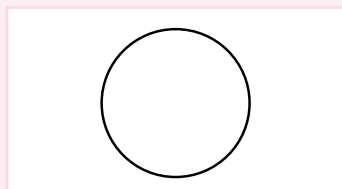

cod.	Misure Size	Volume Volume	Estrattore Extractor	Tagliapasta Cutter	Produttività Capacity	Teglia Tray
MIGNON A001	Ø40 - h25mm	20 gr	ED 1	TPM 1	32 pcs	20x40 cm
MIGNON B001	Ø40 - h25mm	20 gr	ED 1	TPM 1	48 pcs	30x40 cm
MIGNON C001	Ø40 - h25mm	20 gr	ED 1	TPM 1	96 pcs	60x40 cm
MIGNON A002	Ø40 - h25mm	20 gr	ED 2	TPM 2	32 pcs	20x40 cm
MIGNON B002	Ø40 - h25mm	20 gr	ED 2	TPM 2	48 pcs	30x40 cm
MIGNON C002	Ø40 - h25mm	20 gr	ED 2	TPM 2	96 pcs	60x40 cm
MIGNON A003	Ø40 - h25mm	20 gr	ED 3	TPM 3	32 pcs	20x40 cm
MIGNON B003	Ø40 - h25mm	20 gr	ED 3	TPM 3	48 pcs	30x40 cm
MIGNON C003	Ø40 - h25mm	20 gr	ED 3	TPM 3	96 pcs	60x40 cm
MIGNON A004	Ø40 - h25mm	20 gr	ED 4	TPM 4	32 pcs	20x40 cm
MIGNON B004	Ø40 - h25mm	20 gr	ED 4	TPM 4	48 pcs	30x40 cm
MIGNON C004	Ø40 - h25mm	20 gr	ED 4	TPM 4	96 pcs	60x40 cm
MIGNON A005	Ø40 - h25mm	20 gr	ED 5	TPM 5	32 pcs	20x40 cm
MIGNON B005	Ø40 - h25mm	20 gr	ED 5	TPM 5	48 pcs	30x40 cm
MIGNON C005	Ø40 - h25mm	20 gr	ED 5	TPM 5	96 pcs	60x40 cm
MIGNON A006	Ø40 - h25mm	20 gr	ED 6	TPM 6	32 pcs	20x40 cm
MIGNON B006	Ø40 - h25mm	20 gr	ED 6	TPM 6	48 pcs	30x40 cm
MIGNON C006	Ø40 - h25mm	20 gr	ED 6	TPM 6	96 pcs	60x40 cm
MIGNON A007	Ø40 - h25mm	20 gr	ED 7	TPM 7	32 pcs	20x40 cm
MIGNON B007	Ø40 - h25mm	20 gr	ED 7	TPM 7	48 pcs	30x40 cm
MIGNON C007	Ø40 - h25mm	20 gr	ED 7	TPM 7	96 pcs	60x40 cm
MIGNON A008	Ø40 - h25mm	20 gr	ED 8	TPM 8	32 pcs	20x40 cm
MIGNON B008	Ø40 - h25mm	20 gr	ED 8	TPM 8	48 pcs	30x40 cm
MIGNON C008	Ø40 - h25mm	20 gr	ED 8	TPM 8	96 pcs	60x40 cm
MIGNON A009	Ø40 - h25mm	20 gr	ED 9	TPM 9	32 pcs	20x40 cm
MIGNON B009	Ø40 - h25mm	20 gr	ED 9	TPM 9	48 pcs	30x40 cm
MIGNON C009	Ø40 - h25mm	20 gr	ED 9	TPM 9	96 pcs	60x40 cm

SEMIFREDDO MOULDS PLASTIC TRAYS

L'articolo include vassoio e barre:

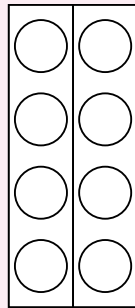

EXTRA A

17x40cm

2 Barre/Moulds

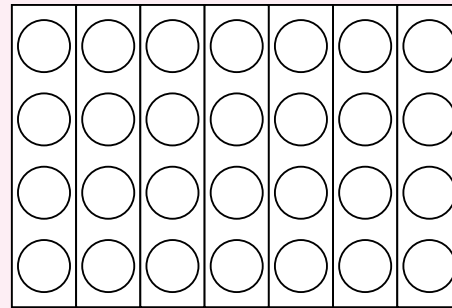

EXTRA C

60x40cm

7 Barre/Moulds

Estrattori e i tagliapasta devono essere ordinati separatamente.
Extractors and cutters must be ordered separately.

Disponibili anche solo i vassoi
Plastic trays only available

Estrattore
Extractor



Tagliapasta
Cutter



Vassoio per MONOP. A

TRAY FOR MONOP. A

cod. **VASSOIOAMO 17x40**

Misura - Size: 397x176 h 19 mm

Vassoio per MONOP. C

TRAY FOR MONOP. C

cod. **VASSOIOCMO 60x40**

Misura - Size: 598x397 h 20 mm

Forma Extra
Extra shape

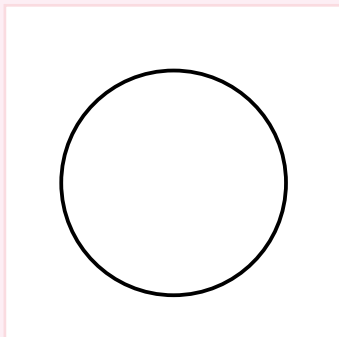

cod.	Misure Size	Volume Volume	Estrattore Extractor	Tagliapasta Cutter
------	----------------	------------------	-------------------------	-----------------------

EXTRA A	Ø80 - h 40 mm	100 gr	EEX1	TPEX 1
EXTRA A01	Ø75 - h 31 mm	75 gr	EEX01	
EXTRA A001	Ø85 - h 31 mm	85 gr	EEX001	
EXTRA A0001	Ø90 - h 40 mm	110 gr	EEX0001	

Produttività
Capacity

8

Teglia
Tray

17x40

EXTRA C	Ø80 - h 40 mm	100 gr	EEX1	TPEX 1
EXTRA C01	Ø75 - h 31 mm	75 gr	EEX01	
EXTRA C001	Ø85 - h 31 mm	85 gr	EEX001	
EXTRA C0001	Ø90 - h 40 mm	110 gr	EEX0001	

Produttività
Capacity

28

Teglia
Tray

60x40

60x40cm

6 Stampi/Moulds

L'articolo include vassoio e barre:



cod. **T6 R5** h50mm Ø 160 - Ø 180 - Ø200 mm
cod. **T6 R4** h40mm Ø 160 - Ø 180 - Ø200 mm

60x40cm

6 Stampi/Moulds

L'articolo include vassoio e barre:



cod. **T6 O5** h50mm Ø 160 - Ø 180 - Ø200 mm
cod. **T6 O4** h40mm Ø 160 - Ø 180 - Ø200 mm

Estrattori - Extractors



cod. **ER3** kit 3 pcs



cod. **EO3** kit 3 pcs

Disponibili anche solo i vassoi: cod. **TEMAXI**
Plastic trays only available: cod. **TEMAXI**

17x40cm

2 Barre/Moulds



cod. **PIRAMTP 02** 70x70 h60mm

26x40cm

3 Barre/Moulds



cod. **PIRAMTP 03** 70x70 h60mm

60x40cm

7 Barre/Moulds



cod. **PIRAMTP 07** 70x70 h60mm



ST STEELS CAKE RINGS



Le fasce inox si prestano sia al congelamento che all'utilizzo in forno, dove assicurano una cottura uniforme.

La varietà di forme e dimensioni, unita alle ampie possibilità di personalizzazione del soggetto su richiesta, rendono le fasce Martellato delle soluzioni versatili in grado di soddisfare anche i pasticceri più esigenti.

Oltre all'idoneità al contatto alimentare, questi strumenti godono delle altre proprietà dell'acciaio inox di cui sono composti:

- facilità di pulizia,
- scarsa deformabilità,
- elevata inerzia chimica (resistenza all'ossidazione, alla corrosione, mancata cessione di sostanze chimiche e mantenimento delle caratteristiche organolettiche del cibo).

The stainless steel cake rings are freezer and oven safe and ensure even cooking.

The variety of shapes and sizes, combined with the wide customization opportunities upon request, make Martellato rings very versatile products able to satisfy even the most demanding pastry chefs.

In addition to being suitable for food contact, these tools share the other properties of the stainless steel they are made of:

- ease of cleaning,
- low deformability,
- high chemical inertia (high resistance to oxidation and corrosion, they do not release any chemicals and maintain the organoleptic properties of food).



cod. 1H2X10	20mm	Ø 100 mm
cod. 1H2X12	20mm	Ø 120 mm
cod. 1H2X14	20mm	Ø 140 mm
cod. 1H2X16	20mm	Ø 160 mm
cod. 1H2X18	20mm	Ø 180 mm
cod. 1H2X20	20mm	Ø 200 mm
cod. 1H2X22	20mm	Ø 220 mm
cod. 1H2X24	20mm	Ø 240 mm
cod. 1H2X26	20mm	Ø 260 mm
cod. 1H2X28	20mm	Ø 280 mm
cod. 1H2X30	20mm	Ø 300 mm

Special for dummies

cod. 40-W087	50mm	Ø 195 mm
cod. 40-W088	50mm	Ø 295 mm
cod. 40-W089	50mm	Ø 395 mm
cod. 40-W090	50mm	Ø 495 mm



cod. 1H4X10	40 mm	Ø 100 mm
cod. 1H4X12	40 mm	Ø 120 mm
cod. 1H4X14	40 mm	Ø 140 mm
cod. 1H4X16	40 mm	Ø 160 mm
cod. 1H4X18	40 mm	Ø 180 mm
cod. 1H4X20	40 mm	Ø 200 mm
cod. 1H4X22	40 mm	Ø 220 mm
cod. 1H4X24	40 mm	Ø 240 mm
cod. 1H4X26	40 mm	Ø 260 mm
cod. 1H4X28	40 mm	Ø 280 mm
cod. 1H4X30	40 mm	Ø 300 mm
cod. 1H5X10	50 mm	Ø 100 mm
cod. 1H5X12	50 mm	Ø 120 mm
cod. 1H5X14	50 mm	Ø 140 mm
cod. 1H5X16	50 mm	Ø 160 mm
cod. 1H5X18	50 mm	Ø 180 mm
cod. 1H5X20	50 mm	Ø 200 mm
cod. 1H5X22	50 mm	Ø 220 mm
cod. 1H5X24	50 mm	Ø 240 mm
cod. 1H5X26	50 mm	Ø 260 mm
cod. 1H5X28	50 mm	Ø 280 mm
cod. 1H5X30	50 mm	Ø 300 mm



cod. 2H4X10	40 mm	115x85 mm
cod. 2H4X12	40 mm	135x100 mm
cod. 2H4X14	40 mm	160x120 mm
cod. 2H4X16	40 mm	185x135 mm
cod. 2H4X18	40 mm	205x155 mm
cod. 2H4X20	40 mm	225x175 mm
cod. 2H4X22	40 mm	253x190 mm
cod. 2H4X24	40 mm	270x210 mm
cod. 2H4X26	40 mm	300x220 mm
cod. 2H4X28	40 mm	320x250 mm
cod. 2H4X30	40 mm	345x260 mm
cod. 2H5X10	50 mm	115x85 mm
cod. 2H5X12	50 mm	135x100 mm
cod. 2H5X14	50 mm	160x120 mm
cod. 2H5X16	50 mm	185x135 mm
cod. 2H5X18	50 mm	205x155 mm
cod. 2H5X20	50 mm	235x165 mm
cod. 2H5X22	50 mm	253x190 mm
cod. 2H5X24	50 mm	275x200 mm
cod. 2H5X26	50 mm	300x220 mm
cod. 2H5X28	50 mm	315x250 mm
cod. 2H5X30	50 mm	335x270 mm

Big



cod. **RETH4** 40 mm 380x580 mm
 cod. **RETH5** 50 mm 380x580 mm

Telaio regolabile in lunghezza ed in larghezza.
 Extendable st. steel frame, length and width adjustable.

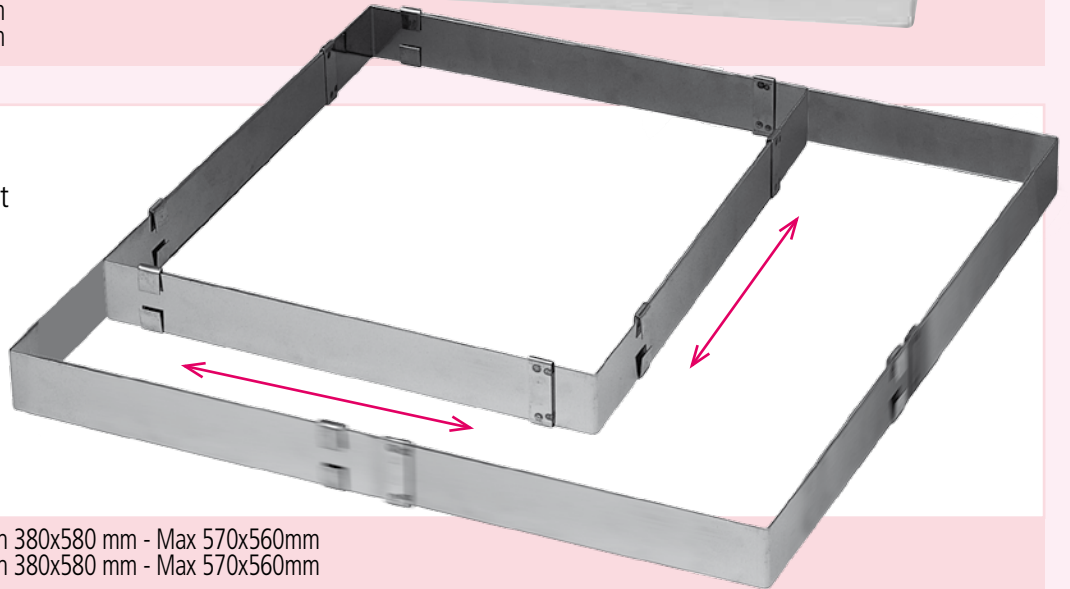

Special

cod. **RETSPECIAL 1** 40 mm Min 380x580 mm - Max 570x560mm
 cod. **RETSPECIAL 2** 50 mm Min 380x580 mm - Max 570x560mm



cod. **3H4X10** 40 mm 175x200 mm
 cod. **3H4X11** 40 mm 195x220 mm
 cod. **3H4X12** 40 mm 210x240 mm
 cod. **3H4X13** 40 mm 235x255 mm
 cod. **3H4X14** 40 mm 245x280 mm
 cod. **3H4X5** 40 mm 90x100 mm
 cod. **3H4X6** 40 mm 125x140 mm
 cod. **3H4X7** 40 mm 120x140 mm
 cod. **3H4X8** 40 mm 140x160 mm
 cod. **3H4X9** 40 mm 160x180 mm
 cod. **3H5X10** 50 mm 175x200 mm
 cod. **3H5X11** 50 mm 195x220 mm
 cod. **3H5X12** 50 mm 210x240 mm
 cod. **3H5X13** 50 mm 225x260 mm
 cod. **3H5X14** 50 mm 245x280 mm
 cod. **3H5X5** 50 mm 90x100 mm
 cod. **3H5X6** 50 mm 106x120 mm
 cod. **3H5X7** 50 mm 120x140 mm
 cod. **3H5X8** 50 mm 140x160 mm
 cod. **3H5X9** 50 mm 160x180 mm



cod. **4H4X10** 40 mm 90x100 mm
 cod. **4H4X12** 40 mm 105x120 mm
 cod. **4H4X14** 40 mm 120x140 mm
 cod. **4H4X16** 40 mm 140x160 mm
 cod. **4H4X18** 40 mm 158x180 mm
 cod. **4H4X20** 40 mm 175x200 mm
 cod. **4H4X23** 40 mm 200x230 mm
 cod. **4H4X25** 40 mm 220x250 mm
 cod. **4H5X10** 50 mm 90x100 mm
 cod. **4H5X12** 50 mm 105x120 mm
 cod. **4H5X14** 50 mm 125x140 mm
 cod. **4H5X16** 50 mm 140x160 mm
 cod. **4H5X18** 50 mm 158x180 mm
 cod. **4H5X20** 50 mm 175x200 mm
 cod. **4H5X23** 50 mm 200x230 mm
 cod. **4H5X25** 50 mm 220x250 mm

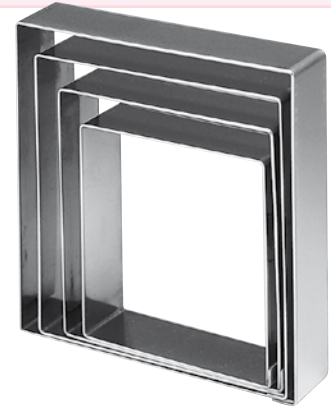

cod. **5H4X10** 40 mm 102x102 mm
 cod. **5H4X12** 40 mm 122x122 mm
 cod. **5H4X14** 40 mm 142x142 mm
 cod. **5H4X16** 40 mm 162x162 mm
 cod. **5H4X18** 40 mm 182x182 mm
 cod. **5H4X20** 40 mm 202x202 mm
 cod. **5H4X22** 40 mm 222x222 mm
 cod. **5H4X24** 40 mm 242x242 mm
 cod. **5H4X26** 40 mm 262x262 mm
 cod. **5H4X28** 40 mm 282x282 mm
 cod. **5H4X30** 40 mm 302x302 mm
 cod. **5H5X10** 50 mm 102x102 mm
 cod. **5H5X12** 50 mm 122x122 mm
 cod. **5H5X14** 50 mm 143x143 mm
 cod. **5H5X16** 50 mm 163x163 mm
 cod. **5H5X18** 50 mm 183x183 mm
 cod. **5H5X20** 50 mm 202x202 mm
 cod. **5H5X22** 50 mm 222x222 mm
 cod. **5H5X24** 50 mm 243x243 mm
 cod. **5H5X26** 50 mm 262x262 mm
 cod. **5H5X28** 50 mm 283x283 mm
 cod. **5H5X30** 50 mm 300x300 mm



cod.	7H4X10	40 mm	115x115 mm
cod.	7H4X12	40 mm	135x130 mm
cod.	7H4X14	40 mm	160x150 mm
cod.	7H4X16	40 mm	175x165 mm
cod.	7H4X18	40 mm	200x185 mm
cod.	7H4X20	40 mm	220x200 mm
cod.	7H4X22	40 mm	235x215 mm
cod.	7H4X24	40 mm	250x245 mm
cod.	7H4X26	40 mm	245x265 mm
cod.	7H4X28	40 mm	285x285 mm
cod.	7H5X10	50 mm	115x115 mm
cod.	7H5X12	50 mm	140x130 mm
cod.	7H5X14	50 mm	160x150 mm
cod.	7H5X16	50 mm	175x165 mm
cod.	7H5X18	50 mm	185x200 mm
cod.	7H5X20	50 mm	213x205 mm
cod.	7H5X22	50 mm	235x210 mm
cod.	7H5X24	50 mm	260x240 mm
cod.	7H5X26	50 mm	283x255 mm
cod.	7H5X28	50 mm	300x278 mm

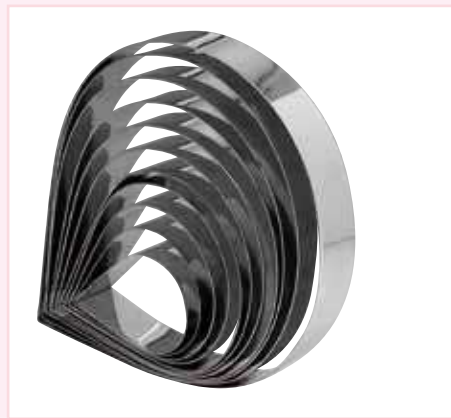

cod.	8H4X10	40 mm	130x82 mm
cod.	8H4X12	40 mm	155x100 mm
cod.	8H4X14	40 mm	175x115 mm
cod.	8H4X16	40 mm	205x127 mm
cod.	8H4X18	40 mm	225x146 mm
cod.	8H4X20	40 mm	250x165 mm
cod.	8H4X22	40 mm	270x180 mm
cod.	8H4X24	40 mm	300x196 mm
cod.	8H4X26	40 mm	325x210 mm
cod.	8H4X28	40 mm	330x255 mm
cod.	8H4X30	40 mm	355x270 mm
cod.	8H5X10	50 mm	125x85 mm
cod.	8H5X12	50 mm	153x97 mm
cod.	8H5X14	50 mm	180x115 mm
cod.	8H5X16	50 mm	180x165 mm
cod.	8H5X18	50 mm	230x145 mm
cod.	8H5X20	50 mm	250x162 mm
cod.	8H5X22	50 mm	275x176 mm
cod.	8H5X24	50 mm	300x192 mm
cod.	8H5X26	50 mm	325x210 mm
cod.	8H5X28	50 mm	350x225 mm
cod.	8H5X30	50 mm	372x245 mm



cod.	9H4X10	40 mm	138x102 mm
cod.	9H4X12	40 mm	170x105 mm
cod.	9H4X14	40 mm	192x145 mm
cod.	9H4X16	40 mm	215x165 mm
cod.	9H4X18	40 mm	235x180 mm
cod.	9H4X20	40 mm	255x190 mm
cod.	9H4X22	40 mm	295x220 mm
cod.	9H4X24	40 mm	312x240 mm
cod.	9H4X26	40 mm	345x240 mm
cod.	9H4X28	40 mm	375x265 mm
cod.	9H5X10	50 mm	135x103 mm
cod.	9H5X12	50 mm	160x125 mm
cod.	9H5X14	50 mm	190x145 mm
cod.	9H5X16	50 mm	215x165 mm
cod.	9H5X18	50 mm	235x180 mm
cod.	9H5X20	50 mm	255x193 mm
cod.	9H5X22	50 mm	295x215 mm
cod.	9H5X24	50 mm	315x235 mm
cod.	9H5X26	50 mm	335x250 mm
cod.	9H5X28	50 mm	375x270 mm



cod.	11H4L24	40 mm	243x142 mm
cod.	11H4L26	40 mm	263x164 mm
cod.	11H4L27	40 mm	268x201 mm
cod.	11H4L28	40 mm	282x183 mm
cod.	11H4L30	40 mm	302x222 mm
cod.	11H4L36	40 mm	360x165 mm
cod.	11H4L38	40 mm	382x262 mm
cod.	11H4L40	40 mm	403x320 mm
cod.	11H5L24	50 mm	242x142 mm
cod.	11H5L26	50 mm	262x164 mm
cod.	11H5L27	50 mm	268x201 mm
cod.	11H5L28	50 mm	285x184 mm
cod.	11H5L30	50 mm	305x223 mm
cod.	11H5L36	50 mm	360x165 mm
cod.	11H5L38	50 mm	382x265 mm
cod.	11H5L40	50 mm	403x302 mm



cod.	12H4X10	40 mm	90x90 mm
cod.	12H4X12	40 mm	106x106 mm
cod.	12H4X14	40 mm	130x130 mm
cod.	12H4X16	40 mm	150x150 mm
cod.	12H4X18	40 mm	175x175 mm
cod.	12H4X20	40 mm	193x193 mm
cod.	12H4X22	40 mm	217x217 mm
cod.	12H4X24	40 mm	237x237 mm
cod.	12H4X26	40 mm	257x257 mm
cod.	12H4X28	40 mm	275x275 mm
cod.	12H4X30	40 mm	300x300 mm
cod.	12H5X10	50 mm	90x90 mm
cod.	12H5X12	50 mm	108x108 mm
cod.	12H5X14	50 mm	130x130 mm
cod.	12H5X16	50 mm	150x150 mm
cod.	12H5X18	50 mm	176x176 mm
cod.	12H5X20	50 mm	194x194 mm
cod.	12H5X22	50 mm	220x220 mm
cod.	12H5X24	50 mm	236x236 mm
cod.	12H5X26	50 mm	250x250 mm
cod.	12H5X28	50 mm	276x276 mm
cod.	12H5X30	50 mm	297x297 mm





cod. **13H4X15** 40mm 150x65 mm
 cod. **13H4X23** 40mm 220x95 mm
 cod. **13H4X30** 40mm 320x125 mm



cod. **14H4X16** 40mm 158x125 mm
 cod. **14H4X20** 40mm 210x165 mm
 cod. **14H4X24** 40mm 240x190 mm
 cod. **14H4X30** 40mm 300x235 mm



cod. **15H4X25** 40mm 250x140 mm
 cod. **15H4X30** 40mm 300x160 mm
 cod. **15H4X34** 40mm 340x180 mm

Strisce decoro in plastica.
 Plastic strips for decoration.



cod. **CORT 4** 800x40 mm 10 pcs
 cod. **CORT 5** 800x50 mm 8 pcs



cod. **25H4X15** 40 mm 150x150 mm
 cod. **25H4X20** 40 mm 200x200 mm
 cod. **25H4X25** 40 mm 250x250 mm
 cod. **25H5X15** 50 mm 150x150 mm
 cod. **25H5X20** 50 mm 200x200 mm
 cod. **25H5X25** 50 mm 250x250 mm



cod. **24H4X15** 40 mm 150x150 mm
 cod. **24H4X20** 40 mm 200x200 mm
 cod. **24H4X25** 40 mm 250x250 mm
 cod. **24H5X15** 50 mm 150x150 mm
 cod. **24H5X20** 50 mm 200x200 mm
 cod. **24H5X25** 50 mm 250x250 mm



cod.	20H2X16	20 mm	160x60 mm
cod.	20H2X21	20 mm	211x61 mm
cod.	20H2X26	20 mm	262x62 mm
cod.	20H2X31	20 mm	313x63 mm
cod.	20H4X16	40 mm	160x60 mm
cod.	20H4X21	40 mm	211x61 mm
cod.	20H4X26	40 mm	262x62 mm
cod.	20H4X31	40 mm	313x63 mm
cod.	20H5X16	50 mm	160x60 mm
cod.	20H5X21	50 mm	211x61 mm
cod.	20H5X26	50 mm	262x62 mm
cod.	20H5X31	50 mm	313x63 mm



cod.	19H2X25	20 mm	250x60 mm
cod.	19H2X30	20 mm	300x61 mm
cod.	19H4X25	40 mm	250x60 mm
cod.	19H4X30	40 mm	300x61 mm
cod.	19H5X25	50 mm	250x60 mm
cod.	19H5X30	50 mm	300x61 mm



cod.	21H2X20	20 mm	200x100 mm
cod.	21H2X25	20 mm	251x101 mm
cod.	21H2X30	20 mm	302x102 mm
cod.	21H2X35	20 mm	353x103 mm
cod.	21H4X20	40 mm	200x100 mm
cod.	21H4X25	40 mm	251x101 mm
cod.	21H4X30	40 mm	302x102 mm
cod.	21H4X35	40 mm	353x103 mm
cod.	21H5X20	50 mm	200x100 mm
cod.	21H5X25	50 mm	251x101 mm
cod.	21H5X30	50 mm	302x102 mm
cod.	21H5X35	50 mm	353x103 mm



cod.	23H2X25	20 mm	250x90 mm
cod.	23H2X30	20 mm	300x91 mm
cod.	23H2X35	20 mm	350x92 mm
cod.	23H4X25	40 mm	250x90 mm
cod.	23H4X30	40 mm	300x91 mm
cod.	23H4X35	40 mm	350x92 mm
cod.	23H5X25	50 mm	250x90 mm
cod.	23H5X30	50 mm	300x91 mm
cod.	23H5X35	50 mm	350x92 mm

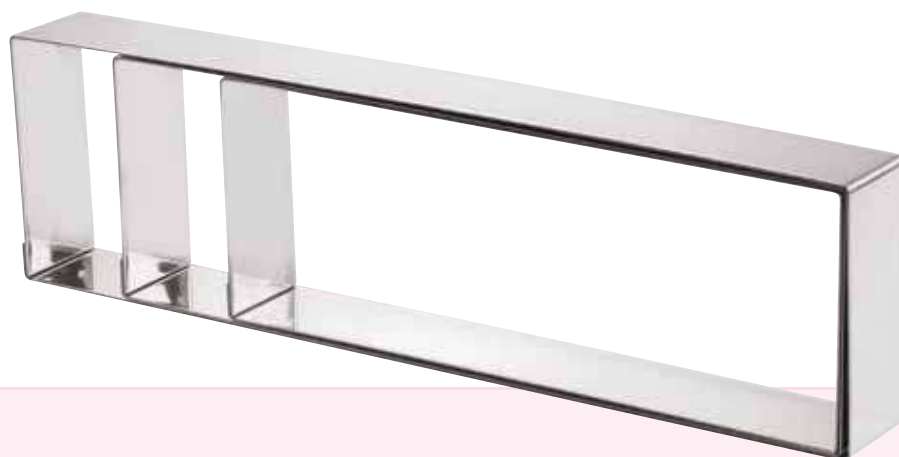

cod.	22H4X36	40 mm	360x100 mm
cod.	22H4X23	40 mm	239x99 mm
cod.	22H5X36	50 mm	360x100 mm
cod.	22H5X23	50 mm	239x99 mm



cod.	30H4X01	forma - shape 1	40 mm	200 mm
cod.	30H4X02	forma - shape 2	40 mm	200 mm
cod.	30H4X03	forma - shape 3	40 mm	200 mm
cod.	30H4X04	forma - shape 4	40 mm	200 mm
cod.	30H4X05	forma - shape 5	40 mm	200 mm
cod.	30H4X06	forma - shape 6	40 mm	200 mm
cod.	30H4X07	forma - shape 7	40 mm	200 mm
cod.	30H4X08	forma - shape 8	40 mm	200 mm
cod.	30H4X09	forma - shape 9	40 mm	200 mm
cod.	30H4X10	forma - shape 0	40 mm	200 mm



cod. 16H4X18	40 mm	180x105 mm
cod. 16H4X21	40 mm	217x128 mm
cod. 16H4X28	40 mm	280x165 mm
cod. 16H5X18	50 mm	180x105 mm
cod. 16H5X21	50 mm	217x128 mm
cod. 16H5X28	50 mm	280x165 mm



cod. 17H4X17	40 mm	175x155 mm
cod. 17H4X21	40 mm	218x194 mm
cod. 17H4X28	40 mm	280x249 mm
cod. 17H5X17	50 mm	175x155 mm
cod. 17H5X21	50 mm	218x194 mm
cod. 17H5X28	50 mm	280x249 mm



cod. 18H4X17	40 mm	175x180 mm
cod. 18H4X20	40 mm	200x206 mm
cod. 18H4X26	40 mm	260x268 mm
cod. 18H5X17	50 mm	175x180 mm
cod. 18H5X20	50 mm	200x206 mm
cod. 18H5X26	50 mm	260x268 mm



cod. 26H4X14	40 mm	146x114 mm
cod. 26H4X15	40 mm	148x132 mm
cod. 26H4X23	40 mm	237x225 mm

Zucca
PUMPKIN



cod. 27H4X12	40 mm	121x180 mm
cod. 27H4X13	40 mm	134x200 mm
cod. 27H4X14	40 mm	148x220 mm
cod. 27H4X16	40 mm	161x240 mm

Zovo

EGG



cod. 29H4X09	40 mm	98x200 mm
cod. 29H4X11	40 mm	112x230 mm
cod. 29H4X12	40 mm	127x260 mm

Coniglio

RABBIT



cod. 28H4X15	40 mm	158x200 mm
cod. 28H4X18	40 mm	181x230 mm
cod. 28H4X20	40 mm	205x260 mm

*Campana
con Fiocco*

BELL WITH RIBBON



cod. 31H4X11	40 mm	117x61 mm
cod. 31H5X11	50 mm	117x61 mm

FETTA *Dolce*

CAKE SLICE



SILICONE MOULDS

Per dolci, crostate, torte salate, pizze, torte, budini, brioches, sformati, sorbetti, gelati, mousse di frutta o verdure... Si puliscono semplicemente sotto un getto di acqua calda, con l'aiuto di una spugna o in lavastoviglie. Per una manutenzione ottimale cospargere lo stampo con farina, cacao o zucchero a velo prima dell'uso.

For cakes, jam tarts, savoury flans, pizzas, puddings, buns, sorbets, fruit or vegetable mousses... They can be easily cleaned with a sponge and hot water or in the dishwasher. We advise you to dust the mould with flour, cocoa powder or icing sugar before using it.

**Non usare l'anello in microonde.
The ring cannot be used in the microwave.**

Imballo nylon trasparente.
Transparent packaging.



STELLA PICCOLA - SMALL STAR

Cod. **SFT 201/Y**
Misura - Size:
Ø 260 h 40 mm



STELLA GRANDE - BIG STAR

Cod. **SFT 202/Y**
Misura - Size:
Ø 260 h 50 mm



PINO - TREE

Cod. **SFT 203/Y**
Misura - Size:
280x200 h 40 mm



ORSETTO - TEDDY BEAR

Cod. **SFT 204/Y**
Misura - Size:
290x200 h 60 mm



CUORE - HEART

Cod. **SFT 210/Y**
Misura - Size:
220x218 h 30 mm



MARGHERITA - MARGUERITE

Cod. **SFT 220/Y**
Misura - Size:
Ø220 h 45 mm



CIAMBELLA - SAVARIN

Cod. **SFT 224/Y**
Misura - Size:
Ø240 h 60 mm



PIZZA

Cod. **SFT 228/Y**
Misura - Size:
Ø280 h 20 mm



GUGELHOPF

Cod. **SFT 250/Y**
Misura - Size:
Ø220 h 110 mm



ROSA - ROSE

Cod. **SFT 251/Y**
Misura - Size:
Ø220 h 100 mm



GIRASOLE - SUNFLOWER

Cod. **SFT 252/Y**
Misura - Size:
Ø260 h 70 mm



RECTANGULAR

Cod. **SFT 300/Y**
Misura - Size:
280x220 h 40 mm



MARGHERITE - DAISY PAN

Cod. **SFT 302/Y**
Misura - Size:
280x215 h 50 mm



TRY ME

Cod. **SFT 514/Y**
Misura - Size:
Ø140 h 50 mm



BRIOCHE

Cod. **SFT 522/Y**
Misura - Size:
Ø220 h 80 mm



METEORA - STAR BUNDT

Cod. **SFT 600/Y**
Misura - Size:
Ø240 h 100 mm



FIORE - FLOWER

Cod. **SFT 722/Y**
Misura - Size:
Ø220 h 100 mm



BRIOCHE

Cod. **SFT 726/Y**
Misura - Size:
Ø260 h 80 mm



PLUM CAKE

Cod. **SFT 730/Y**
Misura - Size:
300x145 h 80 mm



PLUM CAKE

Cod. **SFT 326/Y**
Misura - Size:
240x105 h 65 mm



PLUM CAKE

Cod. **SFT 330/Y**
Misura - Size:
260x100 h 70 mm



CROSTATA - FLAN PAN

Cod. **SFT 424/Y**
Misura - Size:
Ø240 h 30 mm



CROSTATA - FLAN PAN

Cod. **SFT 426/Y**
Misura - Size:
Ø260 h 30 mm



CROSTATA - FLAN PAN

Cod. **SFT 428/Y**
Misura - Size:
Ø280 h 30 mm



TONDO - ROUND

Cod. **SFT 118/Y**
Misura - Size:
Ø180 h 40 mm



TONDO - ROUND

Cod. **SFT 120/Y**
Misura - Size:
Ø200 h 40 mm



TONDO - ROUND

Cod. **SFT 122/Y**
Misura - Size:
Ø220 h 42 mm



TONDO - ROUND

Cod. **SFT 124/Y**
Misura - Size:
Ø240 h 42 mm



TONDO - ROUND

Cod. **SFT 126/Y**
Misura - Size:
Ø260 h 45 mm



TONDO - ROUND

Cod. **SFT 128/Y**
Misura - Size:
Ø280 h 47 mm

SINGLE-SERVINGS SILICONE MOULDS

Misura stampi - Moulds size:
175x300mm

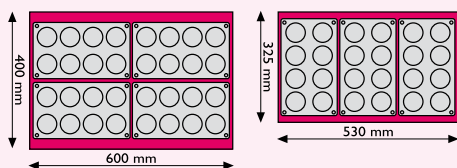

+450°F +230°C
-76°F -60°C

H.A.C.C.P.
NO PROBLEM



SEMISFERA / HALF SPHERE

Cod. **SF001**
Misura - Size:
Ø 80 h 40 mm
5 fig.

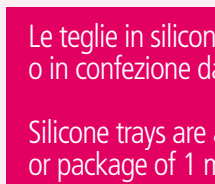

SEMISFERA / HALF SPHERE

Cod. **SF003**
Misura - Size:
Ø 60 h 30 mm
6 fig.

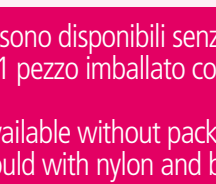

SEMISFERA / HALF SPHERE

Cod. **SF004**
Misura - Size:
Ø 50 h 25 mm
8 fig.

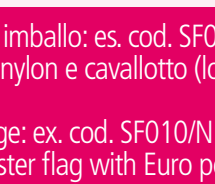

SEMISFERA / HALF SPHERE

Cod. **SF005**
Misura - Size:
Ø 40 h 20 mm
15 fig.

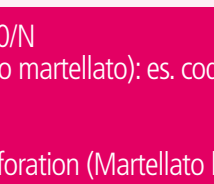

SEMISFERA / HALF SPHERE

Cod. **SF006**
Misura - Size:
Ø 30 h 15 mm
24 fig.



PIRAMIDE - PYRAMID

Cod. **SF007**
Misura - Size:
71x71 h 40 mm
6 fig.

Le teglie in silicone sono disponibili senza imballaggio: es. cod. SF010/N
o in confezione da 1 pezzo imballato con nylon e cavallotto (logo martellato): es. cod. SF010

Silicone trays are available without package: ex. cod. SF010/N
or package of 1 mould with nylon and blister flag with Euro perforation (Martellato logo): ex. cod. SF010



PIRAMIDE - PYRAMID

Cod. **SF008**

Misura - Size:
36x36 h 22 mm
15 fig.



POMPONETTE

Cod. **SF009**

Misura - Size:
Ø 34 h 16 mm
24 fig.



SAVARIN

Cod. **SF010**

Misura - Size:
Ø 41 h 12 mm
18 fig.



SAVARIN

Cod. **SF011**

Misura - Size:
Ø 65 h 21 mm
8 fig.



SAVARIN

Cod. **SF012**

Misura - Size:
Ø 72 h 23 mm
6 fig.



TARTELETTA - TARTLET

Cod. **SF013**

Misura - Size:
Ø 45 h 10 mm
15 fig.



TARTELETTA - TARTLET

Cod. **SF014**

Misura - Size:
Ø 50 h 15 mm
15 fig.



TARTELETTA - TARTLET

Cod. **SF015**

Misura - Size:
Ø 60 h 17 mm
8 fig.



TARTELETTA - TARTLET

Cod. **SF016**

Misura - Size:
Ø 70 h 20 mm
6 fig.



OVALI - OVAL

Cod. **SF017**

Misura - Size:
55x33 h 20 mm
16 fig.



OVALI - OVAL

Cod. **SF018**

Misura - Size:
70x50 h 20 mm
9 fig.



BABA

Cod. **SF019**

Misura - Size:
Ø 35 h 38 mm
15 fig.



BABA

Cod. **SF020**

Misura - Size:
Ø 45 h 48 mm
11 fig.



BABA

Cod. **SF021**

Misura - Size:
Ø 55 h 60 mm
8 fig.



MUFFIN

Cod. **SF022**

Misura - Size:
Ø 51 h 28 mm
11 fig.



MUFFIN

Cod. **SF023**

Misura - Size:
Ø 69 h 35 mm
6 fig.



MUFFIN

Cod. **SF024**

Misura - Size:
Ø 81 h 32 mm
5 fig.



FINANZIERE

Cod. **SF025**

Misura - Size:
49x26 h 11 mm
20 fig.



CAKE

Cod. **SF026**

Misura - Size:
79x29 h 30 mm
12 fig.



PETITE FOUR

Cod. **SF027**

Misura - Size:
Ø40 h 20 mm
15 fig.



CILINDRO - CYLINDER

Cod. **SF028**

Misura - Size:
Ø60 h 35 mm
8 fig.



FIorentINE

Cod. **SF029**

Misura - Size:
Ø60 h 12 mm
8 fig.



FIorentINE

Cod. **SF030**

Misura - Size:
Ø35 h 5 mm
24 fig.



MADALEINE

Cod. **SF031**

Misura - Size:
44x34 h 10 mm
15 fig.



MADALEINE

Cod. **SF032**

Misura - Size:
68x45 h 17 mm
9 fig.



BORDELAIS

Cod. **SF033**

Misura - Size:
Ø35 h 35 mm
18 fig.



BRIOCLETTE

Cod. **SF034**

Misura - Size:
79 h 37 mm
6 fig.



BRIOCLETTE

Cod. **SF035**

Misura - Size:
Ø79 h 30 mm
6 fig.



CUORE - HEART

Cod. **SF036**

Misura - Size:
Ø65 h 60 mm
6 fig.



OTTAGONO - OCTAGON

Cod. **SF037**

Misura - Size:
Ø38 h 26 mm
15 fig.



BARCETTA - BOAT

Cod. **SF038**

Misura - Size:
72x30 h 15 mm
12 fig.



BARCETTA - BOAT

Cod. **SF039**

Misura - Size:
100x44 h 15 mm
9 fig.



CUORE - HEART

Cod. **SF040**

Misura - Size:
Ø60 h 35 mm
8 fig.



MEZZO UOVO - HALF EGG

Cod. **SF041**

Misura - Size:
102x73 h 36 mm
5 fig.



DISCO - SPONGE BASE

Cod. **SF042**

Misura - Size:
Ø103 h 13 mm
15 fig.



TORTINA - FLAN

Cod. **SF043**

Misura - Size:
Ø40 h 13 mm
15 fig.



TORTINA - FLAN

Cod. **SF044**
Misura - Size:
Ø50 h 14 mm
15 fig.



TORTINA - FLAN

Cod. **SF045**
Misura - Size:
Ø60 h 17 mm
8 fig.



TORTINA - FLAN

Cod. **SF046**
Misura - Size:
Ø70 h 17 mm
6 fig.



TORTINA - FLAN

Cod. **SF047**
Misura - Size:
Ø80 h 18 mm
6 fig.



DIAMANTE - DIAMOND

Cod. **SF048**
Misura - Size:
Ø35 h 23 mm
18 fig.



DIAMANTE - DIAMOND

Cod. **SF049**
Misura - Size:
Ø68 h 45 mm
6 fig.



BORDELAIS

Cod. **SF050**
Misura - Size:
Ø55 h 50 mm
8 fig.



BAVARESE

Cod. **SF051**
Misura - Size:
Ø57 h 57 mm
8 fig.



MUFFIN

Cod. **SF052**
Misura - Size:
Ø75 h 60 mm
6 fig.



KRAPFEN

Cod. **SF053**
Misura - Size:
Ø60 h 20 mm
6 fig.



FINAZIERE

Cod. **SF054**
Misura - Size:
95x45 h 12 mm
7 fig.



OVALI - OVAL

Cod. **SF055**
Misura - Size:
75x55 h 35 mm
8 fig.



MARGHERITA - MARGUERITE

Cod. **SF056**
Misura - Size:
Ø70 h 28 mm
6 fig.



GUGELHOPF

Cod. **SF057**
Misura - Size:
Ø55 h 36 mm
8 fig.



GUGELHOPF

Cod. **SF058**
Misura - Size:
Ø70 h 36 mm
6 fig.



BORDELAIS

Cod. **SF059**
Misura - Size:
Ø45 h 45 mm
18 fig.



TORRONCINI - NOUGAT

Cod. **SF060**
Misura - Size:
50x25 h 20 mm
20 fig.



MIX

Cod. **SF061**
Misura - Size:
Ø75 h 40 mm
2x3 fig.

Con i taglia pasta su misura la preparazione dei vostri prodotti sarà ancora più facile e rapida.
Preparing your best products will be even easier and faster using our dough cutters.

Cod. **CUTTER 50**
cutter per SF014

Cod. **CUTTER 80**
cutter per SF047



Sostegno in acciaio inox per sgocciolare le teglie
Stainless steel support to leave the tray dry.

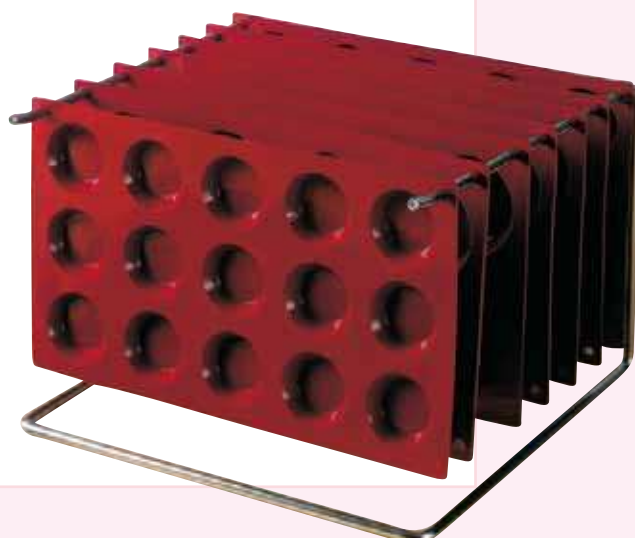

Cod. **DRIP**

CHRISTMAS EQUIPMENT

Stampi pandoro in alluminio
Aluminium pandoro mould

cod. 30SP0100	100 gr
cod. 30SP0250	250 gr
cod. 30SP0500	500 gr
cod. 30SP1000	1000 gr





Ghiera girapanettoni

Realizzata con punte in acciaio inox AISI 316 e quindi adatta al contatto alimentare.

Di facile impilamento sia su carrelli che su rastrelliere murali.

Perfetto ancoraggio di tutti i tipi di stampi (colombe-stelle-cake-alberti etc..)

Impugnatura salda e sicura

Ghiera in acciaio inox che permette una chiusura ottimale.

Support with nails for "Panettoni"

Tips made of AISI 316 stainless steel and therefore suitable for food contact.

Easy to stack both on trolleys and wall racks.

Perfect adhesion on all types of moulds
(colombe-stars-cake-alberti etc..)

Firm and safe grip.

Stainless steel nail for optimal fastening.

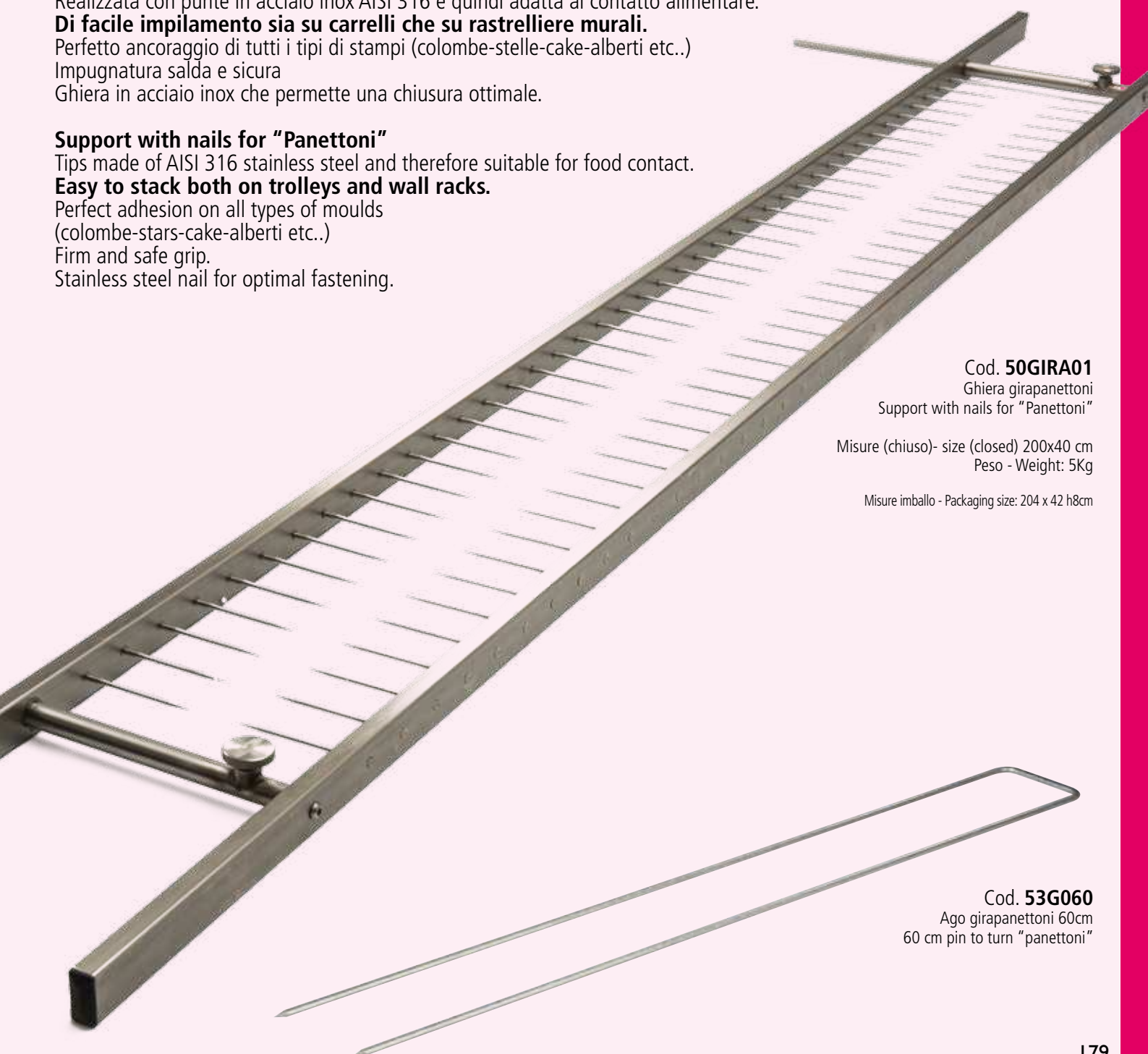

Cod. **50GIRA01**

Ghiera girapanettoni
Support with nails for "Panettoni"

Misure (chiuso)- size (closed) 200x40 cm
Peso - Weight: 5Kg

Misure imballo - Packaging size: 204 x 42 h8cm

Cod. **53G060**

Ago girapanettoni 60cm
60 cm pin to turn "panettoni"

JELLY MOULDS

Stampi per gelatine, in puro silicone alimentare, per la realizzazione di gelatine alla frutta, fondenti, ecc. Telaio in plastica.

Silicone moulds for fruit jelly, fondant, etc. Plastic frame.

Dimensione placca
Moulds size 18x33,5 cm



SPICCHIO - ORANGE SLICE

Cod. **SG 01**
Misura - Size:
45x18 h 15 mm
24 fig.



PERA - PEAR

Cod. **SG 02**
Misura - Size:
40x26 h 15 mm
24 fig.



CUORE - HEART

Cod. **SG 03**
Misura - Size:
34x30 h 18 mm
24 fig.



MEZZASFERA - HALFSPIHERE

Cod. **SG 04**
Misura - Size:
Ø27 h 13,5 mm
24 fig.



BON BON - PASTILLE

Cod. **SG 05**
Misura - Size:
Ø30 h 11 mm
24 fig.



MORA - BERRY

Cod. **SG 06**
Misura - Size:
Ø30 h 24 mm
24 fig.



ANANAS - PINEAPPLE

Cod. **SG 07**
Misura - Size:
33x23 h 18 mm
24 fig.



FRAGOLA - STRAWBERRY

Cod. **SG 08**
Misura - Size:
30x30 h 20 mm
24 fig.



PESCA - PEACH

Cod. **SG 09**
Misura - Size:
35x25 h 20 mm
24 fig.

HOW TO USE



1

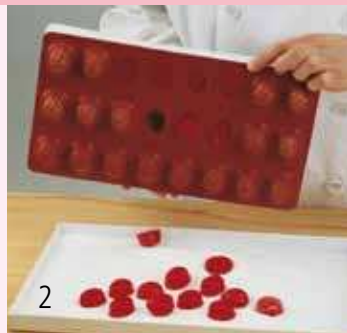

2

1 - Colare la gelatina su ogni cavità con lo speciale colino inox. Cod. 50CO001
2 - Una volta raffreddato il prodotto, rovesciare lo stampo sopra una bacinella contenente zucchero.

1 - Pour the jelly in each single mould using the special piston funnel. Cod. 50CO001
2 - Once cooled, turn the mould upside down in a sugar basin.

MACARON EQUIPMENT



Cod. 30TM6001R

Tappeto silicone 59x39cm
per macaron Ø40mm
Per la cottura dei macaron.
Silicone mat 59x39cm
for macaron Ø40mm
Suitable for macaron baking.
70 gusci/shells



Cod. 30TM3001R

Tappeto silicone 30x40cm
per macaron Ø40mm
Per la cottura dei macaron.
Silicone mat 30x40cm
for macaron Ø40mm
Suitable for macaron baking.
34 gusci/shells

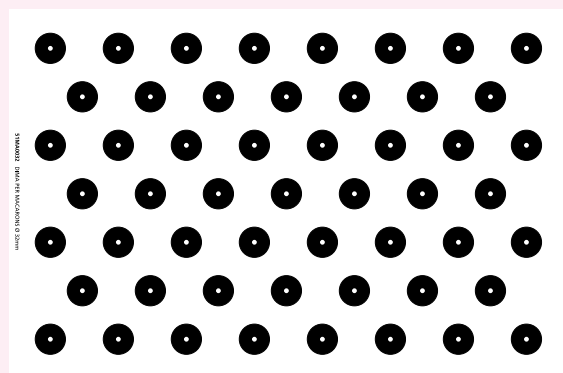

Cod. 51MA0032

Dima 59x39 cm in plastica
per macaron Ø32mm
Non adatta alla cottura.
Il prodotto va posizionato su foglio di carta da forno, la cui trasparenza permette di vedere dove posizionare l'impasto dei Macaron.

Plastic template 59x39 cm for macarons Ø32mm.
Not suitable for cooking.
The product must be placed on grease-proof paper: its transparency allows you to see where to place macaron dough.

Cod. 51CF6040

Carta forno professionale resistente
ai grassi e all'umidità.
Professional baking paper, greaseproof
and humidity resistant.
60x40 cm - Pack 500 pcs



Ampia gamma di espositori per Macaron a pagina 244
Wide range of macaron displays see page 244



Per visualizzare imballi ed espositori disponibili vedi da pg 128 a pg 133
To see available packaging and displays see from page 128 to page 133

ECLAIR EQUIPMENT

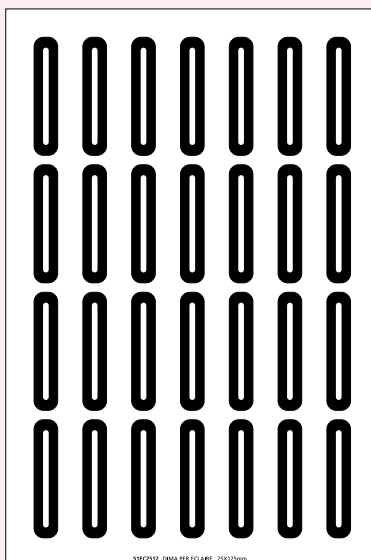

Cod. 51EC2512

Dima 59x39 cm in plastica
per éclair 25x125mm

Non adatta alla cottura.

Il prodotto va posizionato su foglio di carta da forno, la cui trasparenza permette di vedere dove posizionare l'impasto dell' Eclairs

Plastic template 59x39 for éclairs 25x125 mm

Not suitable for cooking.

The product must be placed on grease-proof paper: its transparency allows you to see where to place éclair dough.

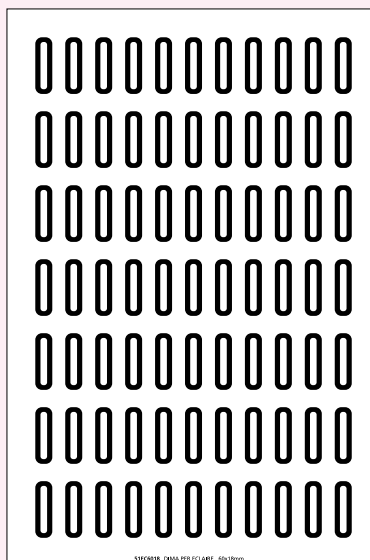

Cod. 51EC6018

Dima 59x39 cm in plastica
per éclair 18x60mm

Non adatta alla cottura.

Il prodotto va posizionato su foglio di carta da forno, la cui trasparenza permette di vedere dove posizionare l'impasto dell' Eclairs

Plastic template 59x39 for éclairs 18x60mm

Not suitable for cooking.

The product must be placed on grease-proof paper: its transparency allows you to see where to place éclair dough.

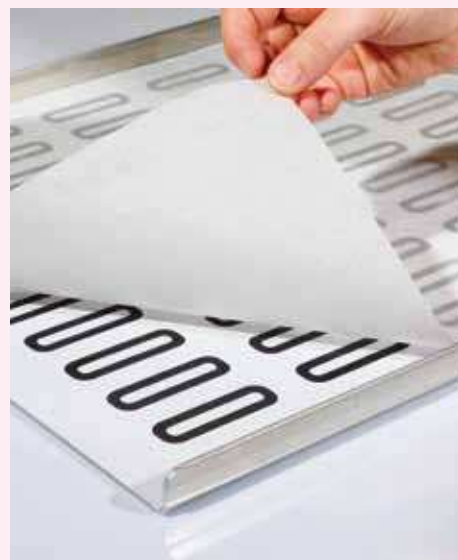

Cod. 50VP00402

Vassoio in plexiglass con bordi.

Ideale per Eclair e Mini Eclair

Misura - Size: 140x400mm

Plexiglass tray with edges

ideal for Éclair and Miniéclair

Size: 140x400mm



Cod. 30TE6001R

Tappeto silicone 59x39 cm
per éclair 25x125mm
Per la cottura di Eclairs

Silicone mat 59x39 cm for éclairs 25x125mm
Suitable for éclairs baking.

Cod. 30TE6002R

Tappeto silicone 59x39 cm
per éclair 18x60mm
Per la cottura dei Mini Eclairs

Silicone mat 59x39 cm for éclairs 18x60mm
Suitable for mini éclairs baking.



Per la cottura si consiglia di utilizzare una teglia forata a due bordi.
For baking, it is advisable to use a perforated baking tray with two edges.



Cod. 31CUT01

Tagliapasta 25x125mm
per decorazione pasta mandorle
Pastry cutter 25x125mm
to decorate almond paste



Cod. 31CUT02

Tagliapasta 18x60mm
per decorazione pasta mandorle
Pastry cutter 18x60mm
to decorate almond paste



Cod. 20EC01

Stampi per decorazioni cioccolato
per Eclair 25x125mm
Kit 6 stampi - prod 36 decori
Moulds for chocolate decorations 25x125mm
6 moulds kit - capacity 36 decorations

Cod. 20EC02

Stampi per decorazioni cioccolato
per Mini Eclair 18x60mm
Kit 6 stampi - prod 36 decori
Moulds for chocolate decorations 18x60mm
6 moulds kit - capacity 72 decorations



SEMIFREDDO MOULDS

Dedichiamo al mondo della gelateria un'invenzione pensata appositamente per i negozi aperti tutto l'anno, ma perfetta anche per chi vuole proporre nel proprio banco frigo qualcosa di veramente nuovo. WINTER ICE è una linea composta da cinque stampi in plastica ideali per la produzione artigianale di semifreddi e gelati da presentare su stecco anche nella stagione più fredda.

Le cinque forme: tondo, ventaglio, oblungo, fiore 6 petali e fiore 3 petali sono proposte singolarmente e abbinate al relativo tagliapasta in plastica necessario per tagliare la base di biscuit o pan di spagna.

And now, for the ice-cream world, an invention specifically designed for the shops which are open all year long but also perfect for those who wants to propose in their freezer display cabinets something new. WINTER ICE is a line of five plastic moulds ideal for the production of handmade desserts and ice creams on a stick, perfect even in winter.

Five shapes available: round, fan, oblong, three and six petals flowers: they are offered individually and combined with the plastic cutter needed to cut the biscuit or sponge cake base.

WinterICE
linea professionale stampi semifreddo

HOW TO USE

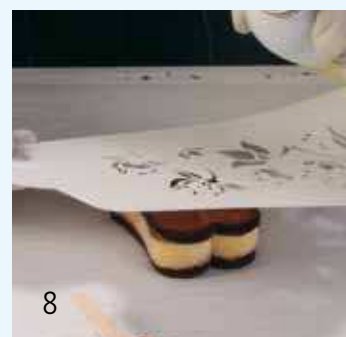
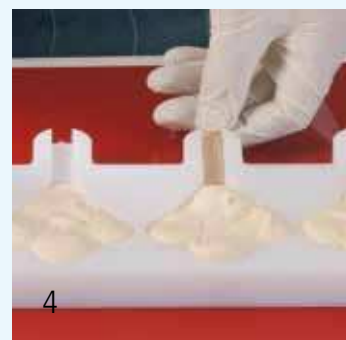
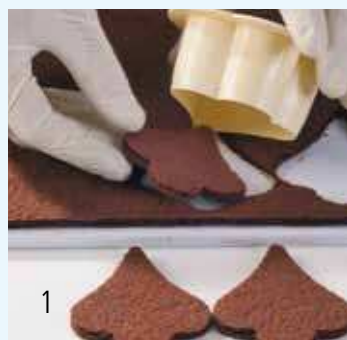

Stampi in plastica per semifreddo Plastic semifreddo moulds

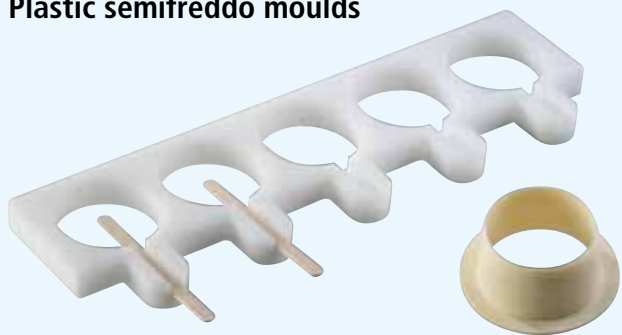

Cod. **10-W001**

Semifreddo: Ø65 h20 mm

Prod: 5 pcs

Stampo - Mould: 390x115 h20 mm

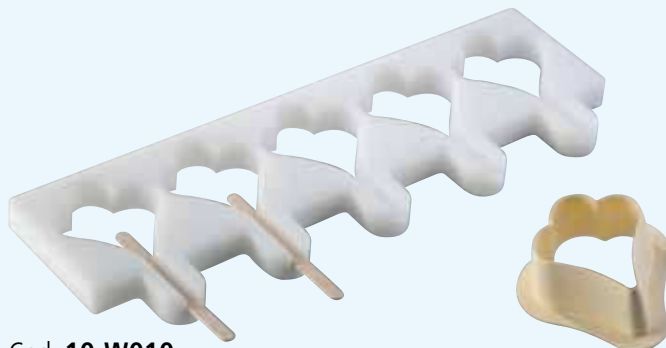

Cod. **10-W010**

Semifreddo: 70x85 h20 mm

Prod: 5 pcs

Stampo - Mould: 390x135 h20 mm

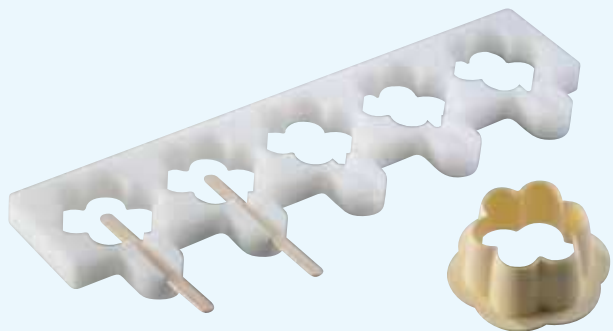

Cod. **10-W012**

Semifreddo: Ø70 h20 mm

Prod: 5 pcs

Stampo - Mould: 390x115 h20 mm

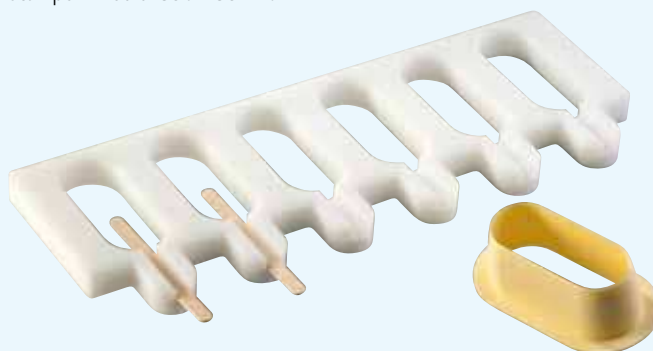

Cod. **10-W013**

Semifreddo: 95x40 h20 mm

Prod: 6 pcs

Stampo - Mould: 390x145 h20 mm

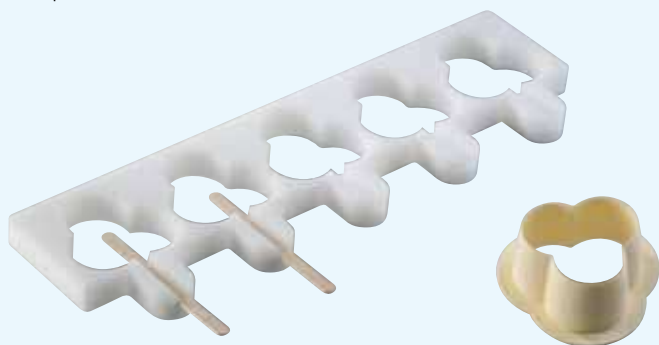

Cod. **10-W014**

Semifreddo: 70x70 h20 mm

Prod: 5 pcs

Stampo - Mould: 390x115 h20 mm



Cod. **STLG100**

Stecchi in legno

Wooden sticks

50 pcs

Espositori in plexiglass - Plexiglass displays

Cod. **10-E003**

Misura - Size: 165x360 h50 mm

Cap. 16 pcs - 24 pcs oblungo

Adatto a banco frigo: - Suitable for fridge display counter

Cod. **10-E004**

Misura - Size: 245x360 h50 mm

Cap. 24 pcs - 40 pcs oblungo

Adatto a banco frigo: - Suitable for fridge display counter



Cod. **10-E005**

Misura - Size: 310x250 h110 mm

Cap. 24 pcs

Adatto a vetrina verticale: - Suitable for vertical showcase

ICE LOLLY MOULDS

GhiaccioloFlex

La rivoluzione dedicata alla produzione artigianale di ghiaccioli su stecco.

Lo stampo GHIACCIOLO-Flex di Martellato vanta delle caratteristiche che lo rendono unico e insostituibile.

Lo straordinario materiale plastico scelto e utilizzato per la sua produzione lo rende particolarmente flessibile ma assolutamente indeformabile e resistente alle basse temperature.

Inoltre, la plastica utilizzata garantisce una facile estrazione del prodotto finito ed elimina qualsiasi rischio di rottura sia dello stampo che del ghiacciolo.

The revolution dedicated to the artisan production of ice lollies on stick.

The features of our GHIACCIOLO-Flex make it unique.

The extraordinary plastic material selected and used for its production makes it absolutely non-deformable but particularly flexible and resistant to low temperature.

Furthermore, the plastic used ensures easy removal of the finished product and eliminates any risk of breaking of the mould and of the ice lolly too.



HOW TO USE



Stampi Ghiacciolo su stecco Ice-lolly on a stick moulds



Cod. **105001**
Heart
Prod: 24 pcs
80/85 gr approx



Cod. **105002**
Recouvert
Prod: 24 pcs
80/85 gr approx



Cod. **105003**
Twig
Prod: 24 pcs
80/85 gr approx



new
Cod. **105000**
Wave
Prod: 24 pcs
80/85 gr approx



Cod. **STLG100**
Stecchi in legno
Wooden sticks
50 pcs

Espositori in plexiglass - Plexiglass displays

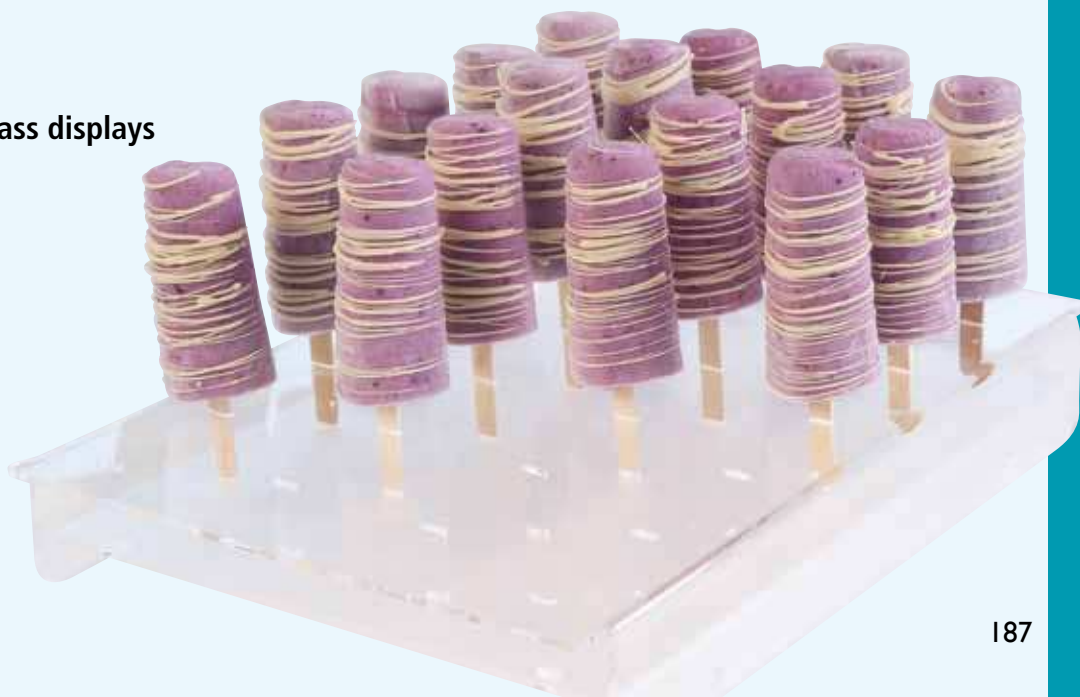

Cod. **10-E002**
Misura - Size: 360x250 h50mm
Cap. 24 pcs

BABY ICE LOLLY MOULDS *Baby Ice®*

Confezione 80 stampi in plastica per produrre coloratissimi e freschissimi Ghiaccioli di Frutta. Un ottimale intreccio di simpatia e genuinità degli ingredienti che solo la vera produzione artigianale può offrire.

80 plastic moulds kit to produce fresh fruit coloured ice-llolies.

The perfect mix of congeniality and genuine ingredients that can be provided only by craftsmen.

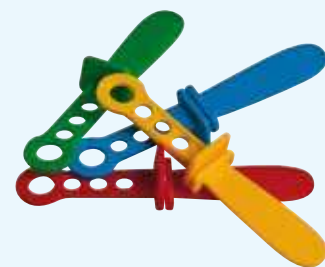
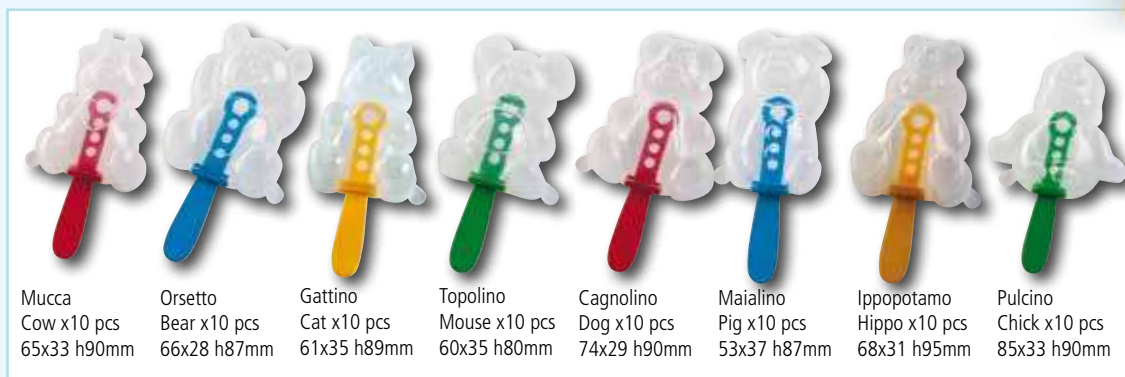

Cod. **SBIKIT01**
80 pcs (8 mod.x10 pcs)

Cod. **BST100**
Sticks 100 pcs (mix)

HOW TO USE

Posizionare lo stecco in plastica nell'apposito spazio prestando attenzione al senso della linguetta, la quale dovrà coprire totalmente il foro per evitare l'uscita del liquido.
Place the plastic stick in the right space. Please note that the tab must fully cover the hole to prevent the spillage of liquid.



Espositori per BABY ICE BABY ICE displays

Espositore in plexiglass satinato per vetrina orizzontale
Glazed plexiglass display for horizontal showcases



cod. **ESPICE14** 160x360 h35 mm 14 sedi - holes
cod. **ESPICE21** 250x360 h35 mm 21 sedi - holes

Espositore in plexiglass trasparente per vetrina verticale
Transparent plexiglass display for vertical showcases



cod. **ESPICE** 310x250 h110 mm 20 sedi - holes

CLASSIC ICE LOLLY MOULDS *IceTube*

Lo stesso concetto di stampo/imballo applicato in versione COOL alla più classica forma per ghiaccioli.

The same idea of mould/packaging is applied to the most classical Ice lolly shape but in a COOLER version.

Cod. **CLP01**
100 pcs
150 ml



Espositori per ICE TUBE ICE TUBE displays

Supporto in plastica bianca per abbattitore
White plastic holder for blast chiller



cod. **CLPESPOB** 290x390 h120 mm 28 sedi - holes

Espositore in plexiglass satinato per vetrina orizzontale
Glazed plexiglass display for horizontal showcases



cod. **CLPESPO15** 160x360 h45 mm 15 sedi - holes
cod. **CLPESPO21** 250x360 h45 mm 21 sedi - holes

Espositore in plexiglass trasparente per vetrina verticale
Transparent plexiglass display for vertical showcases

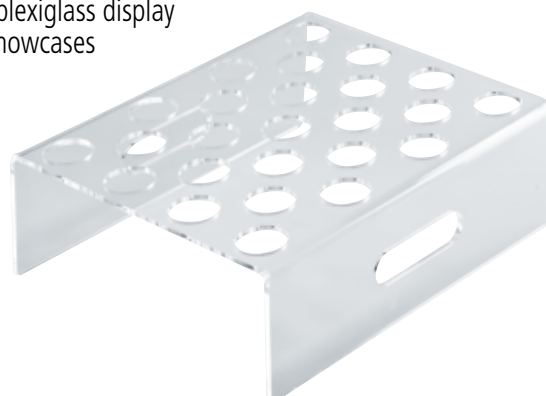

cod. **CLPESPOBTRA** 280x360 h120 mm 25 sedi - holes

PUSH UP POPS MOULDS



L'equilibrato miscuglio di caratteristiche che rendono questo prodotto unico nel suo genere sono: funzionalità, praticità e velocità d'uso, eleganza, versatilità. Basti pensare che lo stesso stampo diventa, nella fase successiva alla produzione del gelato, un elegante sistema per esporre il prodotto in vetrina. La trasparenza dello stampo inoltre esalta la decorazione multicolore, stimolando l'artista gelatiere a decorazioni sempre più raffinate e ricercate. Facilmente adattabile anche alla stagione più fredda, lo stampo Push up Pops può essere proposto anche in versione semifreddo.

The mix of features that makes this product unique are: functionality, convenience, speed of use, elegance, versatility. Just think about how the same mould becomes, in the next step after the creation of ice cream, an elegant system to expose the product in a display.

The transparency of the mould enhances the multi-colored decorations and stimulates ice cream artists to create ever more refined and sophisticated decorations.

Easy adaptable even to winter, Push up Pops comes in the semifreddo version too.



HOW TO USE



1



2



3



4

Contenitori a stantuffo per gelato o altri tipo di dessert
Plunger ice-cream containers

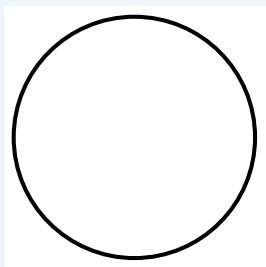

Cod. **GST01**
TONDI - ROUNDS
100 pcs
90ml approx

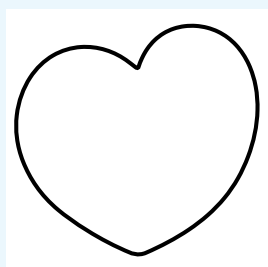

Cod. **GST02**
CUORI - HEARTS
100 pcs
90ml approx

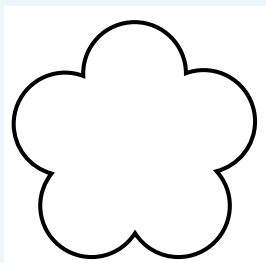

Cod. **GST03**
FIORI - FLOWERS
100 pcs
90ml approx



PUSH UP POPS DISPLAYS



Espositore in plexiglass trasparente
Transparent plexiglass display

Non adatto all'esposizione dei Mini Push Up Pops
Not suitable for displaying Mini Push Up Pops

Sede tonda
Round hole



cod. **GSTESPO24** Ø370 h355 mm 24 sedi - holes
cod. **GSTESPO44** Ø480 h420 mm 44 sedi - holes

Espositore in plexiglass trasparente
Transparent plexiglass display

Non adatto all'esposizione dei Mini Push Up Pops
Not suitable for displaying Mini Push Up Pops

Piatto - Plate: Ø 21 cm

Sede tonda
Round hole



cod. **GSTESPO36** Ø480 h330 mm 36 sedi - holes

Espositori per PUSH UP POPS PUSH UP POPS displays

Supporto in plastica bianca per abbattitore
White plastic holder for blast chiller

Non adatto all'esposizione dei Mini Push Up Pops
Not suitable for displaying Mini Push Up Pops



cod. **GSTESPOB** 310x400 h90 mm 28 sedi - holes

Espositori satinati per vetrina gelato, occupano lo spazio di
vaschette standard.

Glazed displays for standard ice-cream tray size.

Non adatto all'esposizione dei Mini Push Up Pops
Not suitable for displaying Mini Push Up Pops



cod. **GSTESPO15** 160x360 h40 mm 15 sedi - holes
cod. **GSTESPO21** 250x360 h40 mm 21 sedi - holes

Espositore in plexiglass trasparente per vetrina verticale
Transparent plexiglass display for vertical cabinets

Non adatto all'esposizione dei Mini Push Up Pops
Not suitable for displaying Mini Push Up Pops

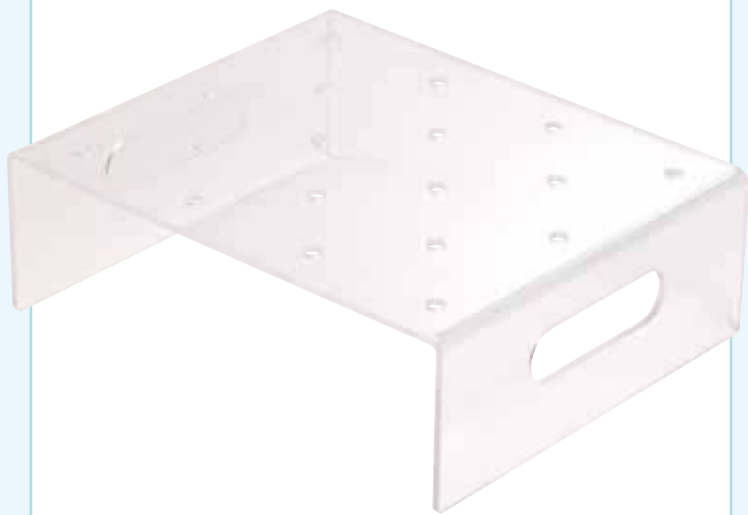

cod. **GSTESPO18** 310x250 h 90 mm 18 sedi - holes

MINI PUSH UP POPS MOULDS



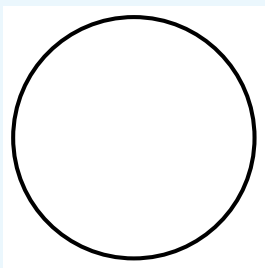

Cod. **GST10**
TONDI - ROUNDS
100 pcs
50ml approx



Espositori per MINI PUSH UP POPS - MINI PUSH UP POPS displays

Supporto in plastica bianca per abbattitore
White plastic holder for blast chiller
Non adatto all'esposizione dei Push Up Pops
Not suitable for displaying Push Up Pops



cod. **GSTESPOBM40** 310x400 h90 mm 40 sedi - holes

Espositore in plexiglass satinato per vetrina orizzontale
Glazed plexiglass display for horizontal cabinet
Non adatto all'esposizione dei Push Up Pops
Not suitable for displaying Push Up Pops



cod. **GSTESPOM21** 360x160 h40 mm 21 sedi - holes
cod. **GSTESPOM35** 360x250 h40 mm 35 sedi - holes

Espositore in plexiglass trasparente per vetrina verticale
Transparent plexiglass display for vertical cabinets
Non adatto all'esposizione dei Push Up Pops
Not suitable for displaying Push Up Pops



cod. **GSTESPOM30** 310x250 h 90 mm 30 sedi - holes



ICE-CREAM SANDWICH MOULDS

CookiePro
linea professionale stampi gelato

 Visualizza i tutorial sul nostro canale **YouTube**
Watch the step-by-step on our **YouTube** channel

Kit stampo gelato biscotto composto da una teglia di sostegno e 3 vassoi estraibili.

La linea di stampi gelato per uso professionale **COOKIE PRO**, risponde ampiamente a tutti i requisiti di funzionalità, qualità e praticità d'uso. L'abbinamento teglia di sostegno in plastica rigida e vassoi estraibili dotati di foro per l'estrazione, semplificano notevolmente la produzione e lo stoccaggio dei gelati biscotto.

Ice-cream sandwich mould kit composed of one support pan and three removable trays.

The **COOKIE PRO** line ice cream moulds for professional users, is a good answer to all requirements of functionality, quality and ease of usage. The combination between the pan support and the hard plastic removable trays, with holes for extraction, greatly simplifies the production and storage of ice cream sandwich.

Stampi per biscotti rotondi
Round cookies moulds

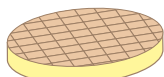

cod. **10-0078** Ø78 mm 18 pcs
cod. **10-0083** Ø83 mm 15 pcs

Stampi per biscotti rettangolari
Rectangular cookies moulds

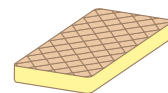

cod. **10-4889** 48,5x89 mm 18 pcs
cod. **10-4887** 48x87,5 mm 18 pcs
cod. **10-6191** 61x91 mm 18 pcs
cod. **10-4770** 48,7x70,2 mm 24 pcs
cod. **10-6798** 67x98 mm 18 pcs

HOW TO USE



Espositori in plexiglass per COOKIE PRO
COOKIE PRO plexiglass displays

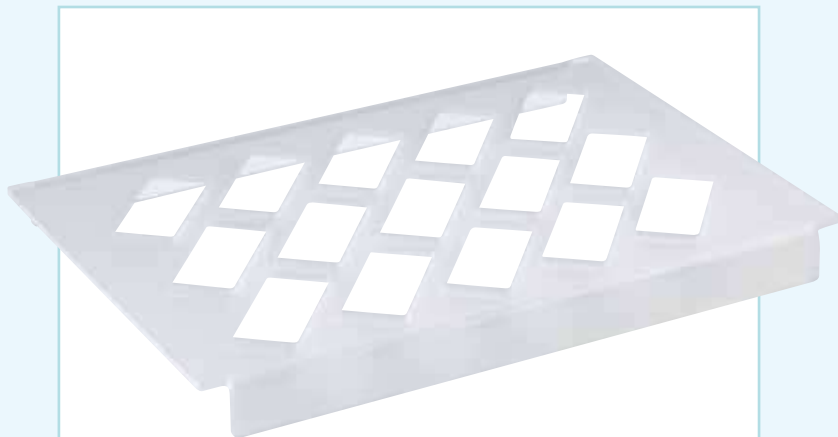

cod. **10-EV008** 165x360 h 27mm 8 bis. suitable for: **10-0083**
 cod. **10-EV010** 165x360 h 27mm 10 bis. suitable for: **10-0078**
 cod. **10-EV012** 245x360 h 27mm 12 bis. suitable for: **10-0083**
 cod. **10-EV015** 245x360 h 27mm 15 bis. suitable for: **10-0078**

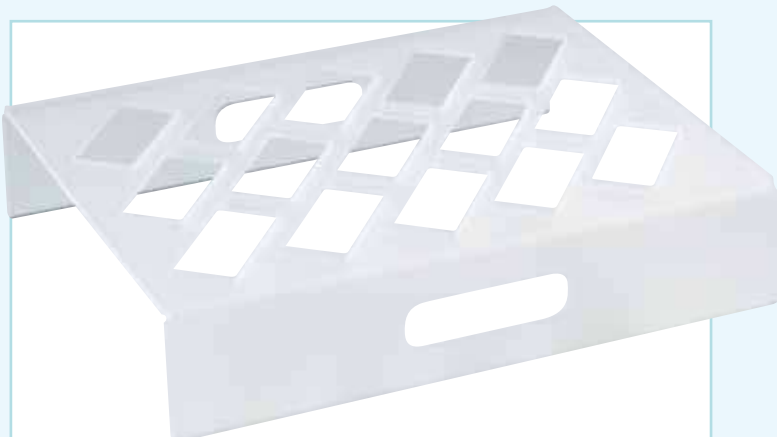

cod. **10-E015** 260x330 h 65mm 15 bis. suitable for: **10-0083**
10-0078



cod. **10-E001** 380x235 h 40mm
 suitable for:
10-4889 / 10-4887 / 10-6191 / 10-4770 / 10-6798



DECORATIVE SCRAPERS

Misura - Size 14,5x15cm

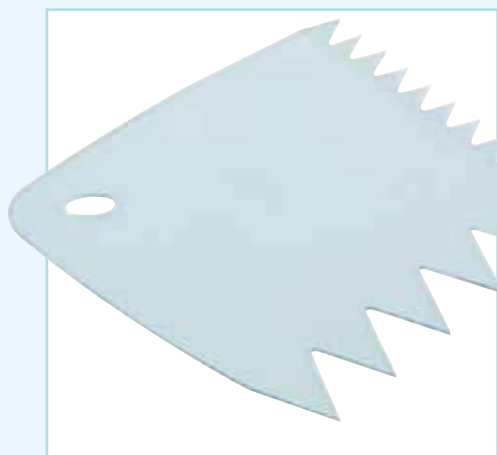

Cod. **RTRA1**

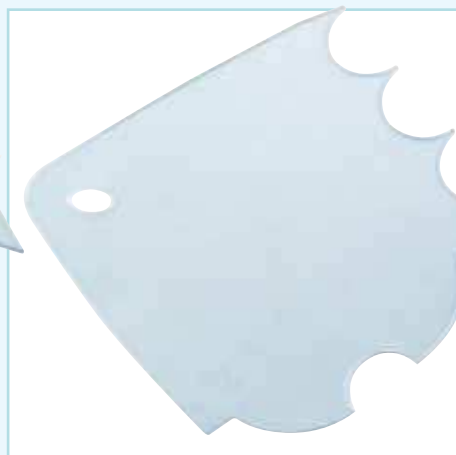

Cod. **RTRA2**

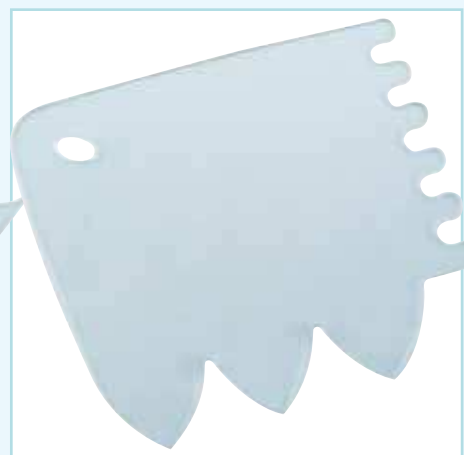

Cod. **RTRA3**



Cod. **RTRA4**



Cod. **RTRA5**

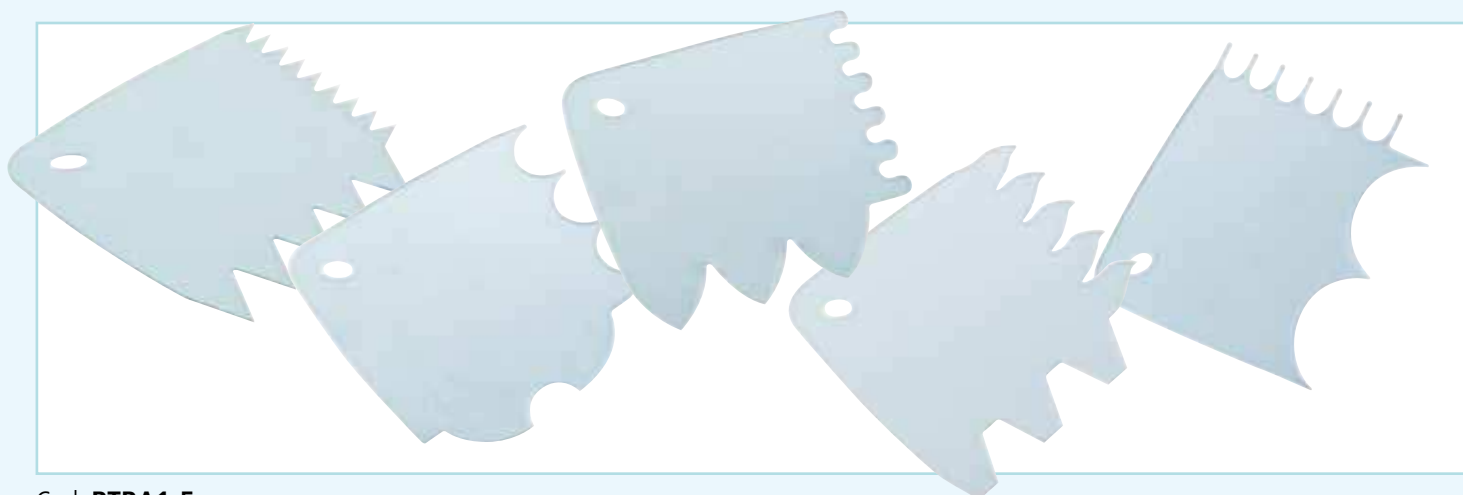

Cod. **RTRA1-5**

Set 5 raschietti decorativi - Set composed of 5 different decorative scrapers

ICE DESSERT MOULDS



icedessert
for all your Creations!

*Gelati, Ghiaccioli, Sorbetti
su stecco...*

e dessert al piatto...

Ice-creams, Ice-lollies, Sorbets
on stick... and desserts...

Cod. 103000

Kit per Ice dessert
Stampo - Mould: 390x83 h67mm
Dessert: 60x36 h66mm
Prod: 5 pcs
80 gr approx

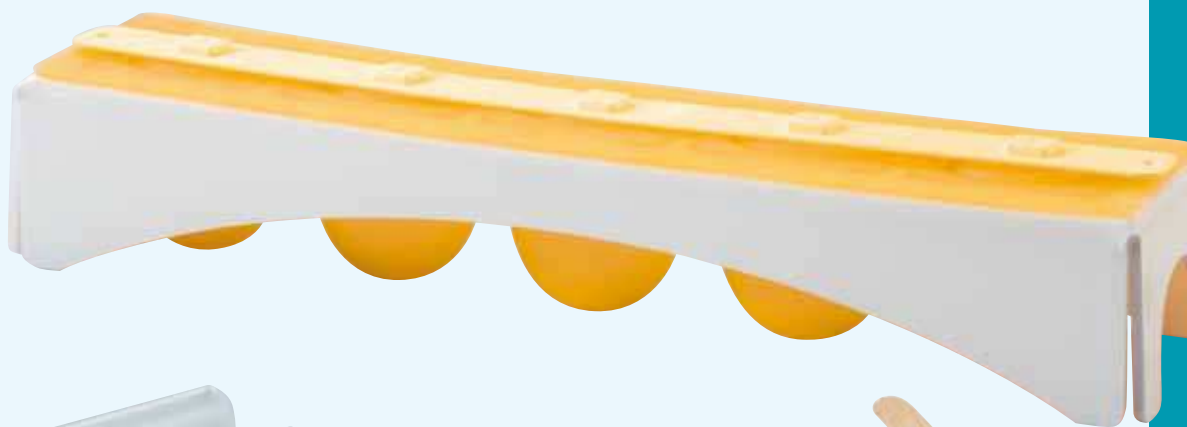

Cod. 10-E001

Espositore per stecchi gelato
Display for Ice creams stiks
Misura - Size: 380x235 h40mm
Cap. 24 pcs



Cod. STL100

Stecchi in legno
Wooden sticks
50 pcs

PROFESSIONAL SPATULAS

Linea SPATOLE GELATO classica e per carapina. Tutti i modelli sono dotati di manico ergonomico per una facile e comoda impugnatura. Entrambe le linee sono caratterizzate da un'ampia gamma di colori pastello in grado di combinarsi in modo equilibrato con le caratteristiche "esteriori" del buon gelato artigianale.

Classic and for cylinder buckets ICE-CREAM SPATULAS line.

All versions are provided with an ergonomic handle for easy and comfortable grip.

Both lines feature a wide range of pastel colours which harmonize with the appearance of fine handmade ice-cream.

LINEA CLASSICA

Lunghezza totale/ Total length: 26cm
Manico/ Handle: 13cm

Cod. **10SG00**
Trasparente - Transparent

Cod. **10SG04**
Azzurro - Sky blue

Cod. **10SG100**
Finto legno - Wood-like

Cod. **10SG01**
Bianco - White

Cod. **10SG05**
Verde - Green

Cod. **10SG02**
Lilla - Lilac

Cod. **10SG06**
Giallo - Yellow

Cod. **10SG03**
Rosa - Pink



LINEA CARAPINA

Lunghezza totale/ Total length: 20cm
Manico/ Handle: 10cm

Cod. **10SGC00**
Trasparente - Transparent

Cod. **10SGC01**
Bianco - White

Cod. **10SGC02**
Lilla - Lilac

Cod. **10SGC03**
Rosa - Pink

Cod. **10SGC04**
Azzurro - Sky blue

Cod. **10SGC05**
Verde - Green

Cod. **10SGC06**
Giallo - Yellow

Cod. **10SGC100**
Carapina finto legno - Wood-like cylinder bucket



Linea spatole gelato con manico ergonomico in plastica, disponibile in otto colori.
Ice cream spatula line with ergonomic plastic handle, available in eight colours.

LINEA CLASSICA

Lunghezza totale/ Total length: 27cm
Manico/ Handle: 14cm

Cod. **SGM00**
Trasparente - Transparent

Cod. **SGM001**
Arancione - Orange

Cod. **SGM002**
Blu - Blue

Cod. **SGM003**
Bianco - White

Cod. **SGM004**
Giallo - Yellow

Cod. **SGM007**
Rosa - Pink

Cod. **SGM008**
Rossa - Red

Cod. **SGM009**
Verde - Green



Cod. **SGM100**
Finto legno - Wood-like

FLAVOUR HOLDERS

Segnagusto ad immersione Immersion flavour holders

Supporto in plexiglass ad immersione e cartellini segnagusto. I supporti sono composti da due parti che devono essere accoppiate per contenere e quindi proteggere il cartellino segnagusto.

Plexiglass immersion support and ice-cream flavour holders. Supports are made up of two parts that must be matched in order to hold and therefore protect the ice-cream flavour marker.

kit 10pcs

Cod. 10SEG

Supporti in plexiglass per segnagusto ad immersione (cartellini non inclusi)
Plexiglass supports for immersion ice-cream flavour holders. (labels not included)
10 pcs - h 19 cm



Cartellini segnagusto in plastica Plastic cards inserted



kit 30pcs

Cod. 10SEG01

LINGUA ITALIANA

Kit cartellini segnagusto FRUTTA
composto da 30 gusti diversi (supporti in plastica non inclusi)

Cod. 10SEG01EN

ENGLISH LANGUAGE

Fruit flavour label kit made up of 30 different flavours
(plastic holders not included)



kit 30pcs

Cod. **10SEG02**
 LINGUA ITALIANA
 Kit cartellini segnagusto CREME
 composto da 30 gusti diversi (supporti in plastica non inclusi)

Cod. **10SEG02EN**
 ENGLISH LANGUAGE
 Fruit flavour label kit made up of 30 different flavours
 (plastic holders not included)



kit 30pcs

Cod. **10SEG03**
 LINGUA ITALIANA
 Kit cartellini segnagusto FRUTTA
 composto da 30 gusti diversi (supporti in plastica non inclusi)



kit 30pcs

Cod. **10SEG04**
 LINGUA ITALIANA
 Kit cartellini segnagusto CREME
 composto da 30 gusti diversi (supporti in plastica non inclusi)

FLAVOUR HOLDERS



Segnagusto ad immersione Immersion flavour marker

Supporto in plexiglass color bianco opale, stampa monofacciale.
Disponibili 96 gusti, altri gusti su richiesta.
Opal white plexiglass holder, one-sided print.
96 flavours available, others upon request.



Mod. **10SEG101**---*

LINGUA ITALIANA

Misure - Size: 190x85mm

* Completa il codice scegliendo i gusti da pagina 206 a 209
Complete the code choosing the flavours from page 206 to 209

Mod. **10SEG051**---*

LINGUA ITALIANA

Misure - Size: 150x70mm

* Completa il codice scegliendo i gusti da pagina 206 a 209
Complete the code choosing the flavours from page 206 to 209

Segnagusto da appoggio Countertop flavour marker

Supporto in plexiglass, color bianco opale, stampa ambedue i lati.
Disponibili 96 gusti, altri gusti su richiesta.
Opal white plexiglass holder, two-sided print.
96 flavours available, others upon request.

Mod. **10SEGC1---***

Misure - Size: 87x52mm

* Completa il codice scegliendo i gusti da pagina 206 a 209
Complete the code choosing the flavours from page 206 to 209



Segnagusto da appoggio Countertop flavour marker

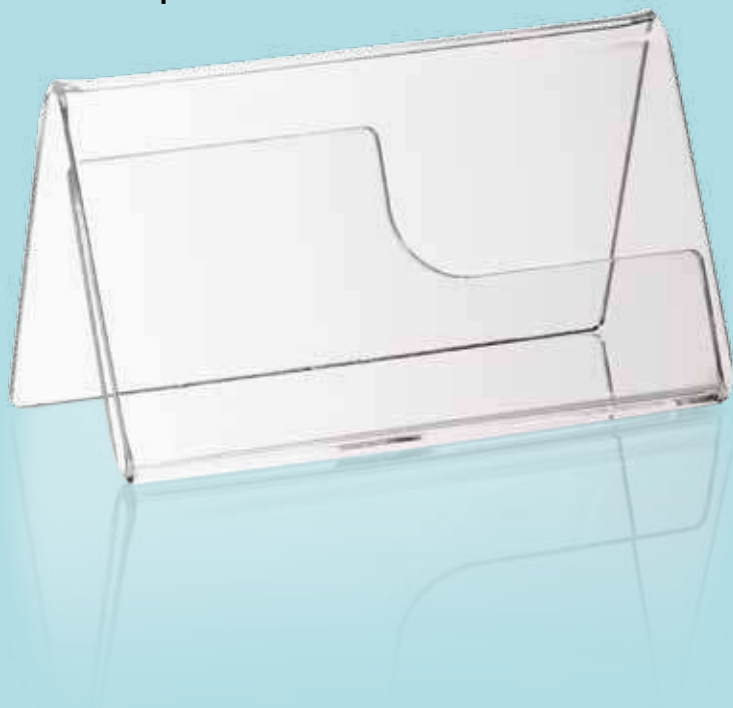

Porta cartellino in plexiglass trasparente per segnagusto.
Transparent plexiglass label holder for flavour marker.

Cod. **10SEGB**

Misure - Size: 87x52mm

Pack 10 pcs

Cartellino in plastica segnagusto, stampa monofacciale
Disponibili 96 gusti, altri gusti su richiesta.

Porta cartellino in plexiglass non incluso.

Plastic label for flavour marker holder, one-sided print.

96 flavours available, others upon request.

Transparent plexiglass label holder not included.

Mod. **10B1---***

Misure - Size: 87x50mm

* Completa il codice scegliendo i gusti da pagina 206 a 209
Complete the code choosing the flavours from page 206 to 209





- Cod. 10B1001 Cod. 10B1002 Cod. 10B1003 Cod. 10B1004 Cod. 10B1005 Cod. 10B1006
- Cod. 10SEGC1001 Cod. 10SEGC1002 Cod. 10SEGC1003 Cod. 10SEGC1004 Cod. 10SEGC1005 Cod. 10SEGC1006
- Cod. 10SEG051001 Cod. 10SEG051002 Cod. 10SEG051003 Cod. 10SEG051004 Cod. 10SEG051005 Cod. 10SEG051006
- Cod. 10SEG101001 Cod. 10SEG101002 Cod. 10SEG101003 Cod. 10SEG101004 Cod. 10SEG101005 Cod. 10SEG101006



- Cod. 10B1007 Cod. 10B1008 Cod. 10B1009 Cod. 10B1010 Cod. 10B1011 Cod. 10B1012
- Cod. 10SEGC1007 Cod. 10SEGC1008 Cod. 10SEGC1009 Cod. 10SEGC1010 Cod. 10SEGC1011 Cod. 10SEGC1012
- Cod. 10SEG051007 Cod. 10SEG051008 Cod. 10SEG051009 Cod. 10SEG051010 Cod. 10SEG051011 Cod. 10SEG051012
- Cod. 10SEG101007 Cod. 10SEG101008 Cod. 10SEG101009 Cod. 10SEG101010 Cod. 10SEG101011 Cod. 10SEG101012



- Cod. 10B1013 Cod. 10B1014 Cod. 10B1015 Cod. 10B1016 Cod. 10B1017 Cod. 10B1018
- Cod. 10SEGC1013 Cod. 10SEGC1014 Cod. 10SEGC1015 Cod. 10SEGC1016 Cod. 10SEGC1017 Cod. 10SEGC1018
- Cod. 10SEG051013 Cod. 10SEG051014 Cod. 10SEG051015 Cod. 10SEG051016 Cod. 10SEG051017 Cod. 10SEG051018
- Cod. 10SEG101013 Cod. 10SEG101014 Cod. 10SEG101015 Cod. 10SEG101016 Cod. 10SEG101017 Cod. 10SEG101018



- Cod. 10B1019 Cod. 10B1020 Cod. 10B1021 Cod. 10B1022 Cod. 10B1023 Cod. 10B1024
- Cod. 10SEGC1019 Cod. 10SEGC1020 Cod. 10SEGC1021 Cod. 10SEGC1022 Cod. 10SEGC1023 Cod. 10SEGC1024
- Cod. 10SEG051019 Cod. 10SEG051020 Cod. 10SEG051021 Cod. 10SEG051022 Cod. 10SEG051023 Cod. 10SEG051024
- Cod. 10SEG101019 Cod. 10SEG101020 Cod. 10SEG101021 Cod. 10SEG101022 Cod. 10SEG101023 Cod. 10SEG101024



- Cod. 10B1025 Cod. 10B1026 Cod. 10B1027 Cod. 10B1028 Cod. 10B1029 Cod. 10B1030
- Cod. 10SEGC1025 Cod. 10SEGC1026 Cod. 10SEGC1027 Cod. 10SEGC1028 Cod. 10SEGC1029 Cod. 10SEGC1030
- Cod. 10SEG051025 Cod. 10SEG051026 Cod. 10SEG051027 Cod. 10SEG051028 Cod. 10SEG051029 Cod. 10SEG051030
- Cod. 10SEG101025 Cod. 10SEG101026 Cod. 10SEG101027 Cod. 10SEG101028 Cod. 10SEG101029 Cod. 10SEG101030



- Cod. 10B1031 Cod. 10B1032 Cod. 10B1033 Cod. 10B1034 Cod. 10B1035 Cod. 10B1036
- Cod. 10SEGC1031 Cod. 10SEGC1032 Cod. 10SEGC1033 Cod. 10SEGC1034 Cod. 10SEGC1035 Cod. 10SEGC1036
- Cod. 10SEG051031 Cod. 10SEG051032 Cod. 10SEG051033 Cod. 10SEG051034 Cod. 10SEG051035 Cod. 10SEG051036
- Cod. 10SEG101031 Cod. 10SEG101032 Cod. 10SEG101033 Cod. 10SEG101034 Cod. 10SEG101035 Cod. 10SEG101036



- Cod. 10B1037 Cod. 10B1038 Cod. 10B1039 Cod. 10B1040 Cod. 10B1041 Cod. 10B1042
- Cod. 10SEGC1037 Cod. 10SEGC1038 Cod. 10SEGC1039 Cod. 10SEGC1040 Cod. 10SEGC1041 Cod. 10SEGC1042
- Cod. 10SEG051037 Cod. 10SEG051038 Cod. 10SEG051039 Cod. 10SEG051040 Cod. 10SEG051041 Cod. 10SEG051042
- Cod. 10SEG101037 Cod. 10SEG101038 Cod. 10SEG101039 Cod. 10SEG101040 Cod. 10SEG101041 Cod. 10SEG101042



- Cod. 10B1043 Cod. 10B1044 Cod. 10B1045 Cod. 10B1046 Cod. 10B1047 Cod. 10B1048
- Cod. 10SEGC1043 Cod. 10SEGC1044 Cod. 10SEGC1045 Cod. 10SEGC1046 Cod. 10SEGC1047 Cod. 10SEGC1048
- Cod. 10SEG051043 Cod. 10SEG051044 Cod. 10SEG051045 Cod. 10SEG051046 Cod. 10SEG051047 Cod. 10SEG051048
- Cod. 10SEG101043 Cod. 10SEG101044 Cod. 10SEG101045 Cod. 10SEG101046 Cod. 10SEG101047 Cod. 10SEG101048



MACEDONIA



MALAGA



MANDARINO



MANDORLA



MANGO



MARRON GLACÉ

- Cod. 10B1049 Cod. 10B1050 Cod. 10B1051 Cod. 10B1052 Cod. 10B1053 Cod. 10B1054
- Cod. 10SEGC1049 Cod. 10SEGC1050 Cod. 10SEGC1051 Cod. 10SEGC1052 Cod. 10SEGC1053 Cod. 10SEGC1054
- Cod. 10SEG051049 Cod. 10SEG051050 Cod. 10SEG051051 Cod. 10SEG051052 Cod. 10SEG051053 Cod. 10SEG051054
- Cod. 10SEG101049 Cod. 10SEG101050 Cod. 10SEG101051 Cod. 10SEG101052 Cod. 10SEG101053 Cod. 10SEG101054



MASCARPONE



MELA VERDE



MELONE



MENTA



MENTA BIANCA



MERINGA

- Cod. 10B1055 Cod. 10B1056 Cod. 10B1057 Cod. 10B1058 Cod. 10B1059 Cod. 10B1060
- Cod. 10SEGC1055 Cod. 10SEGC1056 Cod. 10SEGC1057 Cod. 10SEGC1058 Cod. 10SEGC1059 Cod. 10SEGC1060
- Cod. 10SEG051055 Cod. 10SEG051056 Cod. 10SEG051057 Cod. 10SEG051058 Cod. 10SEG051059 Cod. 10SEG051060
- Cod. 10SEG101055 Cod. 10SEG101056 Cod. 10SEG101057 Cod. 10SEG101058 Cod. 10SEG101059 Cod. 10SEG101060



MIELE



MILLE FOGLIE



MIRTILLO



MORA



NOCCIOLA



NOCE

- Cod. 10B1061 Cod. 10B1062 Cod. 10B1063 Cod. 10B1064 Cod. 10B1065 Cod. 10B1066
- Cod. 10SEGC1061 Cod. 10SEGC1062 Cod. 10SEGC1063 Cod. 10SEGC1064 Cod. 10SEGC1065 Cod. 10SEGC1066
- Cod. 10SEG051061 Cod. 10SEG051062 Cod. 10SEG051063 Cod. 10SEG051064 Cod. 10SEG051065 Cod. 10SEG051066
- Cod. 10SEG101061 Cod. 10SEG101062 Cod. 10SEG101063 Cod. 10SEG101064 Cod. 10SEG101065 Cod. 10SEG101066



PANNA COTTA



PAPAYA

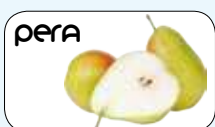

PERA



PESCA



PINOLO



PISTACCHIO

- Cod. 10B1067 Cod. 10B1068 Cod. 10B1069 Cod. 10B1070 Cod. 10B1071 Cod. 10B1072
- Cod. 10SEGC1067 Cod. 10SEGC1068 Cod. 10SEGC1069 Cod. 10SEGC1070 Cod. 10SEGC1071 Cod. 10SEGC1072
- Cod. 10SEG051067 Cod. 10SEG051068 Cod. 10SEG051069 Cod. 10SEG051070 Cod. 10SEG051071 Cod. 10SEG051072
- Cod. 10SEG101067 Cod. 10SEG101068 Cod. 10SEG101069 Cod. 10SEG101070 Cod. 10SEG101071 Cod. 10SEG101072



Cod. 10B1073 Cod. 10B1074 Cod. 10B1075 Cod. 10B1076 Cod. 10B1077 Cod. 10B1078
 Cod. 10SEGC1073 Cod. 10SEGC1074 Cod. 10SEGC1075 Cod. 10SEGC1076 Cod. 10SEGC1077 Cod. 10SEGC1078
 Cod. 10SEG051073 Cod. 10SEG051074 Cod. 10SEG051075 Cod. 10SEG051076 Cod. 10SEG051077 Cod. 10SEG051078
 Cod. 10SEG101073 Cod. 10SEG101074 Cod. 10SEG101075 Cod. 10SEG101076 Cod. 10SEG101077 Cod. 10SEG101078



Cod. 10B1079 Cod. 10B1080 Cod. 10B1081 Cod. 10B1082 Cod. 10B1083 Cod. 10B1084
 Cod. 10SEGC1079 Cod. 10SEGC1080 Cod. 10SEGC1081 Cod. 10SEGC1082 Cod. 10SEGC1083 Cod. 10SEGC1084
 Cod. 10SEG051079 Cod. 10SEG051080 Cod. 10SEG051081 Cod. 10SEG051082 Cod. 10SEG051083 Cod. 10SEG051084
 Cod. 10SEG101079 Cod. 10SEG101080 Cod. 10SEG101081 Cod. 10SEG101082 Cod. 10SEG101083 Cod. 10SEG101084

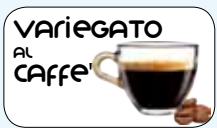

Cod. 10B1085 Cod. 10B1086 Cod. 10B1087 Cod. 10B1088 Cod. 10B1089 Cod. 10B1090
 Cod. 10SEGC1085 Cod. 10SEGC1086 Cod. 10SEGC1087 Cod. 10SEGC1088 Cod. 10SEGC1089 Cod. 10SEGC1090
 Cod. 10SEG051085 Cod. 10SEG051086 Cod. 10SEG051087 Cod. 10SEG051088 Cod. 10SEG051089 Cod. 10SEG051090
 Cod. 10SEG101085 Cod. 10SEG101086 Cod. 10SEG101087 Cod. 10SEG101088 Cod. 10SEG101089 Cod. 10SEG101090



Cod. 10B1091 Cod. 10B1092 Cod. 10B1093 Cod. 10B1094 Cod. 10B1095 Cod. 10B1096
 Cod. 10SEGC1091 Cod. 10SEGC1092 Cod. 10SEGC1093 Cod. 10SEGC1094 Cod. 10SEGC1095 Cod. 10SEGC1096
 Cod. 10SEG051091 Cod. 10SEG051092 Cod. 10SEG051093 Cod. 10SEG051094 Cod. 10SEG051095 Cod. 10SEG051096
 Cod. 10SEG101091 Cod. 10SEG101092 Cod. 10SEG101093 Cod. 10SEG101094 Cod. 10SEG101095 Cod. 10SEG101096

DIVING FORCE GUITARS



Caratteristiche principali:

Il filo corto garantisce una maggiore resistenza meccanica e consente quindi di tagliare in porzioni precise anche gli **impasti molto duri o congelati**. Facile da pulire, questo strumento non richiede alcuna manutenzione.

Main features:

The shortness of wires ensures more mechanical resistance and the **possibility to cut hard and frozen products**.

Easy and practical cleaning.
No maintenance needed.

BIG

PIANO DI TAGLIO - CUTTING PLACE

60x60cm

cod. **CSM060** Taglio - Cut 60x60cm

Misura chitarra chiusa: 73x103 h30cm
Misura apertura massima: 73x167 cm
L'articolo include

- 1 base
- 1 piatto inox.
- 1 racla PST.
- 2 chiavi per il fissaggio fili.

Closed guitar size: 73x103 h30cm
Size open: 73x167 cm
The article includes

- 1 base
- 1 st. steel sheet.
- 1 plastic spatula.
- 2 spanners to change strings.



Telai - non inclusi: Frames - not included:

cod. CSM06001	Telaio / Frame 10 mm
cod. CSM06002	Telaio / Frame 15 mm
cod. CSM06003	Telaio / Frame 20 mm
cod. CSM06004	Telaio / Frame 25 mm
cod. CSM06005	Telaio / Frame 30 mm
cod. CSM06006	Telaio / Frame 35 mm
cod. CSM06007	Telaio / Frame 40 mm
cod. CSM06008	Telaio / Frame 50 mm
cod. CSM06009	Telaio / Frame 60 mm

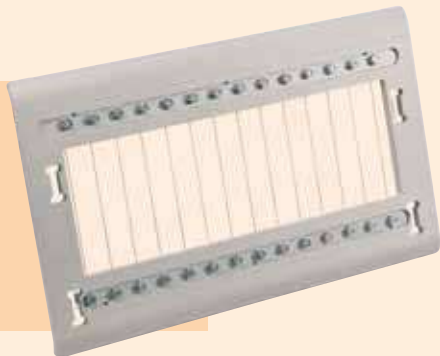

Parti di ricambio - Spare parts

cod. CHITRIC 8	chiavi di fissaggio - spanners
cod. CHITRIC 9	filo inox - inox wire
cod. CSMSPB60	spatola plastica - plastic spatula
cod. CSM0602	piatto inox - inox sheet



HOW TO USE

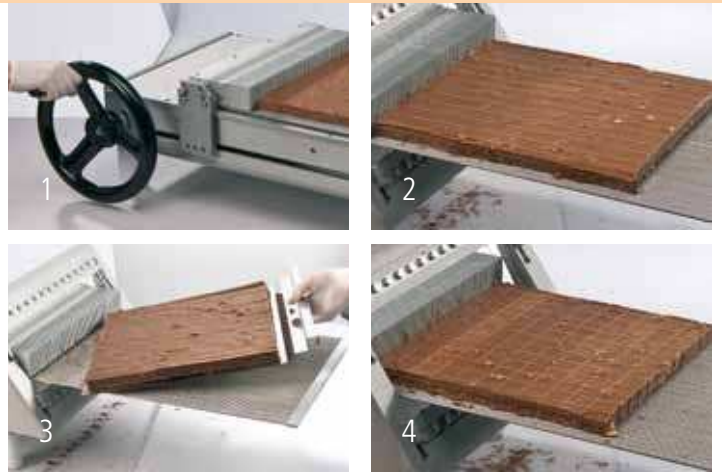
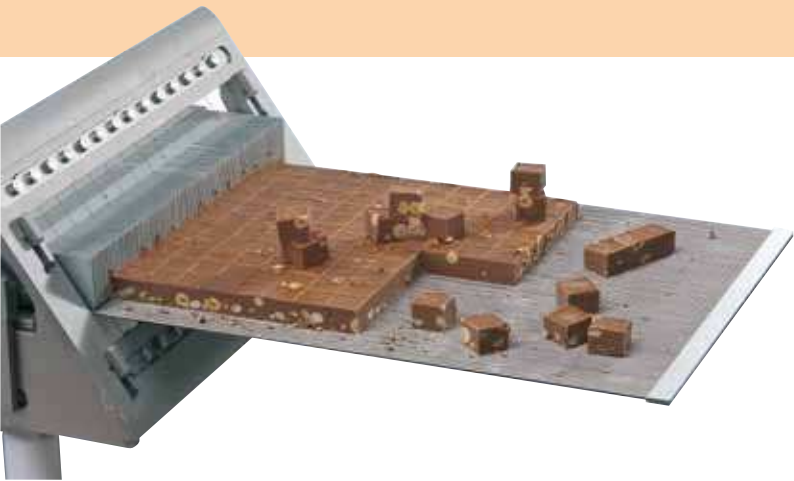

SMALL

PIANO DI TAGLIO - CUTTING PLACE

40x40cm

cod. **CSM040** Taglio - Cut 40x40cm

Misura chitarra chiusa: 53x83 h30cm
Misura apertura massima: 53x126 cm
L'articolo include

- 1 base
- 1 piatto inox.
- 1 racla PST.
- 2 chiavi per il fissaggio fili.

Closed guitar size: 53x83 h30cm
Size open: 53x126 cm
The article includes

- 1 base
- 1 st. steel sheet.
- 1 plastic spatula.
- 2 spanners to change strings.



Telai - non inclusi:
Frames - not included:

cod. CSM04001	Telaio / Frame 10 mm
cod. CSM04002	Telaio / Frame 15 mm
cod. CSM04003	Telaio / Frame 20 mm
cod. CSM04004	Telaio / Frame 25 mm
cod. CSM04005	Telaio / Frame 30 mm
cod. CSM04006	Telaio / Frame 35 mm
cod. CSM04007	Telaio / Frame 40 mm
cod. CSM04008	Telaio / Frame 50 mm
cod. CSM04009	Telaio / Frame 60 mm

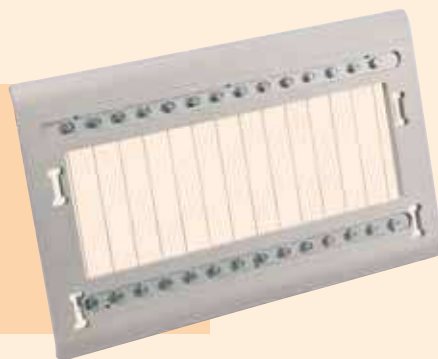

Parti di ricambio - Spare parts

cod. CHITRIC 8	chiavi di fissaggio - spanners
cod. CHITRIC 9	filo inox - inox wire
cod. CSMSPB40	spatola plastica - plastic spatula
cod. CSM0402	piatto inox - inox sheet

GUITARS

Queste chitarre sono ideali per tagliare in precise porzioni gli impasti morbidi come la crema ganache, il pan di Spagna e il cioccolato fuso.

This guitars are ideal for cut in precise portions dough as soft as the ganache cream, sponge cake and chocolate melted.

PIANO DI TAGLIO - CUTTING PLACE

36x41cm

Caratteristiche principali:

Chitarra a taglio semplice con 3 TELAI INCLUSI.

Main features:

Single guitar composed of 3 FRAMES INCLUDED.

cod. **CHITCOMP**

L'articolo include

- 1 Base PST 50x44 h15,5 cm.
- 1 telaio inox per tagli da 22,5 mm.
- 1 telaio inox per tagli da 30 mm.
- 1 telaio inox per tagli da 45 mm.
- 1 piatto inox.
- 1 racla PST.
- 3 fili di ricambio.
- 2 chiavi per il fissaggio fili.

The article includes

- 1 plastic base 50x44 h15,5 cm.
- 1 st. steel cutting frame 22,5 mm.
- 1 st. steel cutting frame 30 mm.
- 1 st. steel cutting frame 45 mm.
- 1 st. steel sheet to put cakes .
- 1 plastic spatula.
- 3 free st. steel strings.
- 2 spanners to change strings.

Telai - non inclusi nel kit:

Frames - not included in the kit:

cod. **CHITRIC 1** Telaio / Frame 15 mm



Parti di ricambio - Spare parts

- cod. **CHITRIC 2** Telaio / Frame 22,5 mm
- cod. **CHITRIC 3** Telaio / Frame 30 mm
- cod. **CHITRIC 4** Telaio / Frame 45 mm
- cod. **CHITRIC 5** Base Pst / Plastic Base 390x450 h130 mm
- cod. **CHITRIC 6/D** Piatto Inox / Steel Sheet 425x425 mm
- cod. **SPB** Racla Pst / Plastic Spatula 555 mm
- cod. **CHITRIC 8** 2 Chiavi Fissaggio / 2 Special Spanner
- cod. **CHITRIC 9** 1 Filo Inox / 1 Steel Strings
- cod. **CHITRIC 10** 2 viti 2 dadi - 2 bolts 2 nuts



PIANO DI TAGLIO - CUTTING PLACE

38x42cm

Caratteristiche principali:

Chitarra a taglio doppio con 4 TELAI INCLUSI.

Main features:

Double guitar composed of 4 FRAMES INCLUDED.

cod. **CHITDOUBLE**

L'articolo include

- 1 Base PST 58,5x48 h15,5cm.
- 1 telaio inox per tagli da 22,5 mm.
- 1 telaio inox per tagli da 30 mm.
- 1 telaio inox per tagli da 45 mm.
- 1 telaio inox per tagli da 30 mm. Telaio fisso laterale
- 1 piatto inox.
- 1 racla PST.
- 3 fili di ricambio.
- 2 chiavi per il fissaggio fili.

The article includes

- 1 plastic base 58,5x48 h15,5cm.
- 1 st. steel cutting frame 22,5 mm.
- 1 st. steel cutting frame 30 mm.
- 1 st. steel cutting frame 45 mm.
- 1 st. steel cutting frame 30 mm. Fixed side steel cutting frame
- 1 st. steel sheet.
- 1 plastic spatula.
- 3 free st. steel strings.
- 2 spanners to change strings.



Telai - non inclusi nel kit:

Frames - not included in the kit:

- cod. **CHITRIC 1/D** Telaio / Frame 15 mm
cod. **CHITRIC 2/LD** Telaio Laterale/ Lateral Frame 20 mm

Parti di ricambio - Spare parts

- cod. **CHITRIC 1/LD** Telaio Laterale/ Lateral Frame 30 mm
cod. **CHITRIC 2/D** Telaio / Frame 22,5 mm
cod. **CHITRIC 3/D** Telaio / Frame 30 mm
cod. **CHITRIC 4/D** Telaio / Frame 45 mm
cod. **CHITRIC 5/D** Base Pst / Plastic Base 390x450 h130 mm
cod. **CHITRIC 6/D** Piatto Inox / Steel Sheet 425x425 mm
cod. **SPB** Racla Pst / Plastic Spatula 555 mm
cod. **CHITRIC 8** 2 Chiavi Fissaggio / 2 Special Spanner
cod. **CHITRIC 9** 1 Filo Inox / 1 Steel Strings
cod. **CHITRIC 10** 2 viti 2 dadi - 2 bolts 2 nuts

NEW SYSTEM GUITARS



Il **nuovo sistema ad incastro** facilita notevolmente l'inserimento ed il cambio dei telai, riducendo sensibilmente i tempi di montaggio, smontaggio e manutenzione.

La chitarra è composta da una nuova e più solida base in plastica e da una serie di telai di diverse misure fornibili separatamente in base alle esigenze del singolo operatore, è predisposta per il taglio di grandi quantità di cioccolatini calibrati e tagliati in modo preciso e privo di imperfezioni.

The **new simple system of interlocking frames** incredibly reduces assembly and disassembly time, it is sufficient to place them in the seats and you're done. The guitar is capable of cutting large amounts of cremini perfectly matched with a clean and precise cut.

PIANO DI TAGLIO - CUTTING PLACE

36x42cm

Caratteristiche principali:

Chitarra a taglio semplice **TELAI NON INCLUSI**.

Main features:

Single guitar **FRAMES NOT INCLUDED**.

cod. **50-CS100**

L'articolo include

- 1 Base PST 44x52 h15,5cm.
- 1 piatto inox.
- 1 racla PST.
- 3 fili di ricambio.
- 2 chiavi per il fissaggio fili.

The article includes

- 1 plastic base 44x52 h15,5cm.
- 1 plastic spatula.
- 3 free st. steel strings.
- 2 spanners to change strings.

Telai - non inclusi nel kit:

Frames - not included in the kit:

cod. 50-C015	Telaio / Frame 15 mm
cod. 50-C022	Telaio / Frame 22,5 mm
cod. 50-C030	Telaio / Frame 30 mm
cod. 50-C045	Telaio / Frame 45 mm

Parti di ricambio - Spare parts

cod. SPB	Racla Pst / Plastic Spatula 555 mm
cod. CHITRIC 6/D	Piatto Inox / Steel Sheet 425x425 mm
cod. CHITRIC 9	2 Chiavi Fissaggio / 2 Special Spanner
cod. CHITRIC 8	1 Filo Inox / 1 Steel Strings
cod. CHITRIC 10	2 viti 2 dadi - 2 bolts 2 nuts



HOW TO USE



Posizionare il cremino sulla base in plastica utilizzando l'apposito piatto in acciaio e la spatola.

Nb: il piatto in acciaio serve solo per posizionare il cremino, deve essere tolto prima di abbassare i telai. Abbassare il telaio realizzando il primo taglio. A telaio abbassato rimuovere le strisce di cremino utilizzando sempre il piatto in acciaio.

Place the cremino on the plastic base. Using the special steel tray and spatula the operation will be easier and more precise.

The steel tray serves only to place the cremino, it must be removed before lowering the frame. Lower the frame and make the first cut. After that remove the cremino using the steel tray.

PIANO DI TAGLIO - CUTTING PLACE

35x35cm

Caratteristiche principali:

Chitarra a taglio doppio TELAI NON INCLUSI.

Struttura esterna in alluminio.

Main features:

Double guitar FRAMES NOT INCLUDED.

Aluminium external structure.

I telai in acciaio sono adatti per il taglio frontale e laterale tranne il telaio da 15 mm, predisposto solo al taglio frontale.

The st. steel frames are interchangeable, except the 15mm which cannot be used for side cutting.

cod. **50-CD100N**

L'articolo include

- 1 Base PST 48x48 h14,3cm.
- 1 piatto inox.
- 1 racla PST.
- 3 fili di ricambio.
- 2 chiavi per il fissaggio fili.

The article includes

- 1 plastic base 48x48 h14,3cm.
- 1 plastic spatula.
- 3 free st. steel strings.
- 2 spanners to change strings.

Telai - non inclusi nel kit:

Frames - not included in the kit:

cod. 50-C015	Telaio / Frame 15 mm
cod. 50-C022	Telaio Laterale/ Lateral Frame 22,5 mm
cod. 50-C030	Telaio Laterale/ Lateral Frame 30 mm
cod. 50-C045	Telaio Laterale/ Lateral Frame 45 mm

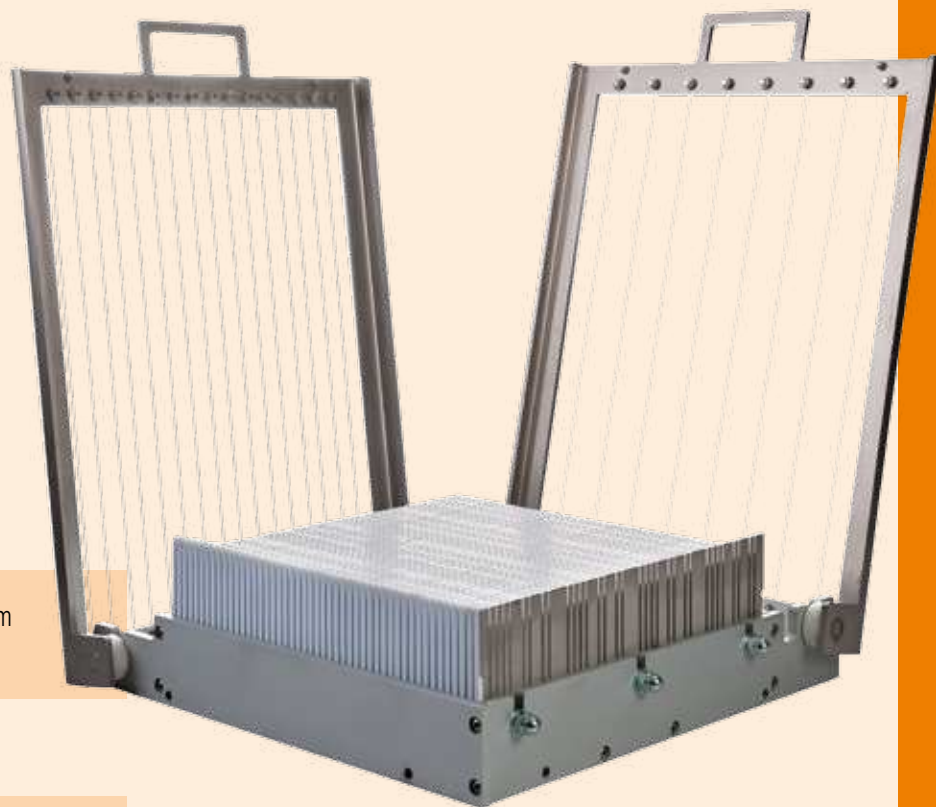

Parti di ricambio - Spare parts

cod. SPB	Racla Pst / Plastic Spatula 555 mm
cod. CHITRIC 6/D	Piatto Inox / Steel Sheet 425x425 mm
cod. CHITRIC 9	2 Chiavi Fissaggio / 2 Special Spanner
cod. CHITRIC 8	1 Filo Inox / 1 Steel Strings
cod. CHITRIC 10	2 viti 2 dadi - 2 bolts 2 nuts

SINGLE CUT MINI GUITARS

PIANO DI TAGLIO - CUTTING PLACE

24x24cm

nuovo sistema ad incastro.
new system of interlocking.



Caratteristiche principali:

Mini chitarre a taglio semplice con 1 telaio incluso.

Base in plastica dimensione utile 24x24 cm.

Ingombro chitarra 46x30 h14cm

Il nuovo sistema ad incastro facilita notevolmente l'inserimento ed il cambio dei telai, riducendo sensibilmente i tempi di montaggio, smontaggio e manutenzione.

Adatte a piccole produzioni è ideale per scuole, ristoranti, gelaterie, piccole cioccolaterie.

Main features:

Mini single guitars composed of 1 frame.

Plastic base 24x24cm. Guitar size 46x30 h14cm

The new simple system of interlocking frames incredibly reduces assembly and disassembly time: it is sufficient to place them in the seats.

Suitable for small productions and for schools, restaurants, ice-cream shops, chocolate shops.

cod. **CHITMINI** con Telaio / with Frame 22 mm
cod. **CHITMINI15** con Telaio / with Frame 15 mm
cod. **CHITMINI30** con Telaio / with Frame 30 mm

L'articolo include

- 1 Base PST
- 1 telaio inox
- 1 piatto inox.
- 1 racla PST.
- 3 fili di ricambio.
- 2 chiavi per il fissaggio fili.

The article includes

- 1 plastic base 39x45 h13cm.
- 1 st. steel cutting.
- 1 st. steel sheet.
- 1 plastic spatula.
- 3 free st. steel strings.
- 2 spanners to change strings.



Telai - acquistabili separatamente

Frames - purchasable separately

cod. **CHIT15** Telaio Frontale/ Frontal Frame 15 mm
cod. **CHIT22** Telaio Frontale-Laterale/ Frontal-Lateral Frame 22 mm
cod. **CHIT30** Telaio Frontale-Laterale/ Frontal-Lateral Frame 30 mm

Parti di ricambio - Spare parts

cod. **CHITBA24** Base PST 240x240 mm
cod. **SPBMINI** Spatola - Plastic spatula
cod. **CHITP** Piatto inox - Inox plate
cod. **CHITRIC 9** Filo inox - St steel string
cod. **CHITRIC 8** Chiavi di fissaggio - Spanners
cod. **CHITRIC 10** 2 viti 2 dadi - 2 bolts 2 nuts



DOUBLE CUT MINI GUITARS

PIANO DI TAGLIO - CUTTING PLACE

24x24cm

nuovo sistema ad incastro.
new system of interlocking.



Caratteristiche principali:

Mini chitarre a taglio doppio con 2 telaio inclusi.

Base in plastica dimensione utile 24x24 cm.

Ingombro chitarra 47x47 h16cm

Il nuovo sistema ad incastro facilita notevolmente l'inserimento ed il cambio dei telai, riducendo sensibilmente i tempi di montaggio, smontaggio e manutenzione.

Adatte a piccole produzioni è ideale per scuole, ristoranti, gelaterie, piccole cioccolaterie.

Main features:

Mini double guitars composed of 2 frames.

Plastic base 24x24cm. Guitar size 47x47 h16cm

The new simple system of interlocking frames incredibly reduces assembly and disassembly time: it is sufficient to place them in the seats.

Suitable for small productions and for schools, restaurants, ice-cream shops, chocolate shops.

cod. **CHITMINID22** con Telaio / with Frame 22 mm

cod. **CHITMINID30** con Telaio / with Frame 30 mm

L'articolo include

- 1 Base PST
- 1 telaio inox
- 1 piatto inox.
- 1 racla PST.
- 3 fili di ricambio.
- 2 chiavi per il fissaggio fili.

The article includes

- 1 plastic base 39x45 h13cm.
- 1 st. steel cutting.
- 1 st. steel sheet.
- 1 plastic spatula.
- 3 free st. steel strings.
- 2 spanners to change strings.

Telai - acquistabili separatamente

Frames - purchasable separately

cod. **CHIT15** Telaio Frontale/ Frontal Frame 15 mm

cod. **CHIT22** Telaio Frontale-Laterale/ Frontal-Lateral Frame 22 mm

cod. **CHIT30** Telaio Frontale-Laterale/ Frontal-Lateral Frame 30 mm



Parti di ricambio - Spare parts

cod. **CHITBAD24** Base PST 240x240 mm

cod. **SPBMINI** Spatola - Plastic spatula

cod. **CHITP** Piatto inox - Inox plate

cod. **CHITRIC 9** Filo inox - St steel string

cod. **CHITRIC 8** Chiavi di fissaggio - Spanners

cod. **CHITRIC 10** 2 viti 2 dadi - 2 bolts 2 nuts

KIT CREMINO

Attrezzatura completa per la realizzazione di cremi-
ni o altri tipi di ganache.
Complete equipment for ganache.

BIG

cod. **TL SPECIAL** 48x60cm

L'articolo include

- 1 Base polietilene
- 1 spatola in plastica
- 2 telai 365x365 h5mm.
- 2 telai 365x365 h3mm.

The article includes

- 1 Polyethylene base
- 1 plastic spatula
- 2 frames 365x365 h5mm.
- 2 frames 365x365 h3mm.

Parti di ricambio - Spare parts

cod. **TLS03** Telaio / Frame h 3 mm
cod. **TLS05** Telaio / Frame h 5 mm
cod. **SPB** Spatola / Spatula



SMALL

cod. **TLMINI** 24x24cm

L'articolo include

- 1 Base polietilene
- 1 spatola in plastica
- 2 telai h5mm.
- 2 telai h3mm.

The article includes

- 1 Polyethylene base
- 1 plastic spatula
- 2 frames h5mm.
- 2 frames h3mm.

Parti di ricambio - Spare parts

cod. **SPB40** spatola - plastic spatula
cod. **TLM03** Telaio / Frame h 3 mm
cod. **TLM05** Telaio / Frame h 5 mm



HOW TO USE



LOGS GUITARS

Caratteristiche principali:

Chitarra a taglio semplice con 3 TELAI INCLUSI. Ideale per il taglio di tronchi o prodotti morbidi lunghi fino a 60cm.

Main features:

Single guitar composed of 3 FRAMES INCLUDED. To cut logs or other soft products not over 60cm long.

cod. **CHITRONK**

L'articolo include

- 1 Base PST 60x34 h13cm
- 1 telaio inox per tagli da 22,5mm.
- 1 telaio inox per tagli da 30mm.
- 1 telaio inox per tagli da 45mm.

The article includes

- 1 plastic base 60x34 h13cm.
- 1 st. steel cutting frame 22,5mm.
- 1 st. steel cutting frame 30mm.
- 1 st. steel cutting frame 45mm.



Parti di ricambio - Spare parts

- cod. **CHITRIC 2/T** Telaio / Frame 22,5 mm
- cod. **CHITRIC 3/T** Telaio / Frame 30 mm
- cod. **CHITRIC 4/T** Telaio / Frame 45 mm
- cod. **CHITRIC 5/T** Base PST 600x340 h 130 mm
- cod. **CHITRIC 8** Chiavi di fissaggio - Spanners
- cod. **CHITRIC 9** Filo inox - St steel string

PASTRY BAGS SAC A POUCHES

Realizzato con un innovativo materiale alimentare che conferisce al prodotto un'elevata resistenza, flessibilità e morbidezza. Il nuovo Superflex presenta una superficie liscia all'interno che facilita la fuoriuscita del prodotto, e ruvida all'esterno per un'impugnatura più salda. Grazie allo speciale e innovativo sistema di saldatura del sacchetto la sicurezza igienica è maggiormente garantita.

An innovative food-safe material than gives high resistance, flexibility and softness to pastry bags. Superflex bags have a smooth internal surface for an easy emission of creams and an external rough surface for a better grip. Thanks to a special welding of the bag we can guarantee a high hygienic safety.

Senza Imballo - Umpacked

cod. SPR034	340mm
cod. SPR045	450mm
cod. SPR050	500mm

Con Imballo - With package

cod. SPR034/C	340mm
cod. SPR045/C	450mm
cod. SPR050/C	500mm



I sacchetti per pasticceria mod. STD sono prodotti con fibre di **cotone** rivestite di poliuretano. Provvisto di asola e **punta rinforzata**.
Standard pastry bags are made of polyurethane coated **cotton** fibers. Turned and sewed rimes, **reinforced tip**.



cod. STD 025 CM	25cm
cod. STD 028 CM	28cm
cod. STD 034 CM	34cm
cod. STD 040 CM	40cm
cod. STD 046 CM	46cm
cod. STD 050 CM	50cm
cod. STD 055 CM	55cm
cod. STD 060 CM	60cm
cod. STD 065 CM	65cm
cod. STD 070 CM	70cm
cod. STD 075 CM	75cm

I sacchetti per pasticceria mod. FLEX sono prodotti con fibre di **poliestere** rivestite di poliuretano. Provvisto di asola.
Flex pastry bags are made of polyurethane coated **polyester** fibers. With welded seam.



cod. FLEX 025 CM	25cm
cod. FLEX 028 CM	28cm
cod. FLEX 034 CM	34cm
cod. FLEX 040 CM	40cm
cod. FLEX 046 CM	46cm
cod. FLEX 050 CM	50cm
cod. FLEX 055 CM	55cm
cod. FLEX 060 CM	60cm
cod. FLEX 065 CM	65cm
cod. FLEX 070 CM	70cm

PASTRY BAGS DISPOSABLE

Green Poche

Caratteristica principale che contraddistingue GREEN POCHE, sacchetto monouso per pasticceri professionisti, è lo speciale materiale con il quale è realizzato. **L'effetto grip del polietilene facilita notevolmente la presa del sacchetto agevolando il lavoro del pasticciere.**

La qualità della sigillatura inoltre, annulla qualsiasi rischio di rottura durante l'utilizzo. **Il prodotto è interamente realizzato in Italia. spessore 80 Micron**

The main feature of our GREEN POCHE, Martellato's disposable bags for professional users, is their special material. **The "grip effect" of polyethylene greatly facilitates pastry chefs' work.** Moreover, the quality of their sealing avoids any risk of breakage during use.

The product is entirely Made in Italy. 80 Microns thick



cod. 50-1030	30cm	box 100 pcs
cod. 50-1040	40cm	box 100 pcs
cod. 50-1055	55cm	box 100 pcs
cod. 50-1065	65cm	box 100 pcs

Espositore in legno da terra per scatole **green poche**.
Standing wooden display for **green poche** boxes.

Cod. **ESPOWG70GP**

Misura/Size:
49,4x46,5 h 150 cm

Crowner non incluso.
Crowner not included.

Cod. **CRWESPOWG70GP**

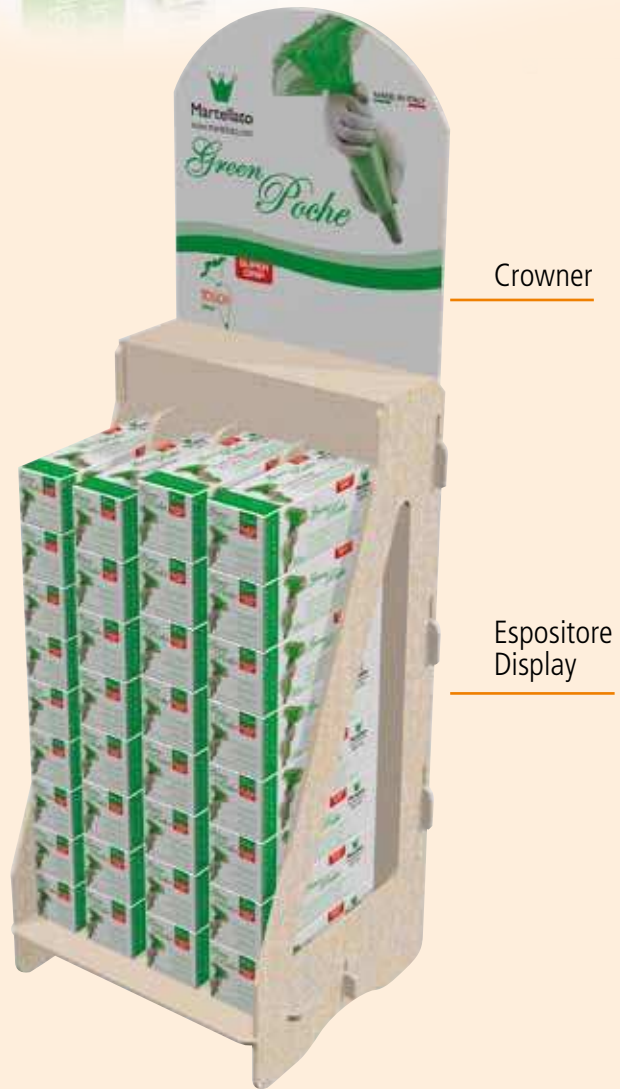

Orange Poche

Sac a poche monouso per alimenti in polietilene arancione, **spessore 70 micron**, rotolo da 100 pz in elegante packaging.

Disposable pastry bags for food made of orange polyethylene, **70 microns thick**, roll of 100 pieces in elegant packaging.

cod. 50-0030	30cm	box 100 pcs
cod. 50-0040	40cm	box 100 pcs
cod. 50-0055	55cm	box 100 pcs
cod. 50-0065	65cm	box 100 pcs



Roll

Sac a poche monouso per alimenti in polietilene trasparente, **spessore 90 Micron**, rotolo da 100 pz in elegante packaging.

Disposable pastry bags for food made of transparent polyethylene, **90 Microns thick**, roll of 100 pieces in elegant packaging.



cod. ROLL H 30	30cm	box 100 pcs
cod. ROLL H 40	40cm	box 100 pcs
cod. ROLL H 55	55cm	box 100 pcs
cod. ROLL H 65	65cm	box 100 pcs

Sac a poche monouso pretagliati per alimenti in polietilene trasparente, **spessore 90 Micron**.
Confezionati in cartone con euroforo.

Disposable pre-cut pastry bags made of transparent polyethylene, **90 microns thick**.
Packed in cardboard boxes with Euro-perforation.

cod. **SAC45X100** 23x45cm box 100 pcs
cod. **SAC58X100** 30x58cm box 100 pcs

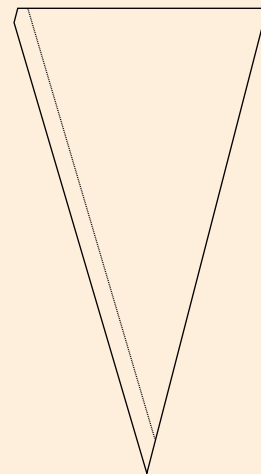

Sac a poche monouso pretagliati per alimenti in polietilene trasparente, **spessore 90 Micron**,
Disponibili confezioni da 25, 50 e 100pz. Doppia saldatura. Confezionati con nylon trasparente.

Disposable precut pastry bags for food made of transparent polyethylene, **90 Microns thick**,
25, 50, 100 pcs packages. Double welding. Packed with transparent nylon.

cod. **SAC 25** 30x50cm box 25 pcs
cod. **SAC 50** 30x50cm box 50 pcs

cod. **SAC 100** 17x30cm box 100 pcs

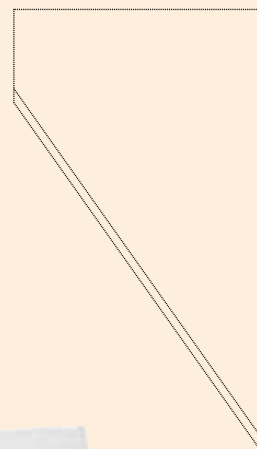

Distributore a muro per sac a poches in rotolo.
Wall rack for roll pastry bags.

Cod. **ROLLER**



Distributore a muro per SAC 25 e SAC 50.
Wall rack for SAC 25 and SAC 50 pastry bags.

Cod. **DISTRIBUTORE**



Vaso porta sac a poche
Pastry bag holder

Cod. **50VA001A**
Ø200 - h240 mm



PASTRY BAGS PIPING TIPS

Kit di bocchette decorative in acciaio inox per sac a poche.
Il kit è composto da 5 bocchette di ugual misura.
 Stainless steel piping tips for pastry bags.
Every kit is composed of 5 piping tips kit of the same size.

SIZE misure esterne
external size

diametro bocchetta
diameter piping tips

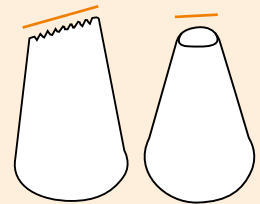
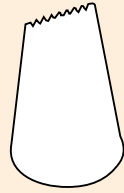

cod.	size	#	cod.	size	#
BT 202	Ø25 h50	2	BT 212	Ø30 h47	12
BT 203	Ø25 h50	3	BT 213	Ø30 h47	13
BT 204	Ø25 h45	4	BT 214	Ø30 h47	14
BT 205	Ø25 h45	5	BT 215	Ø35 h50	15
BT 206	Ø25 h45	6	BT 216	Ø35 h50	16
BT 207	Ø25 h45	7	BT 217	Ø35 h50	17
BT 208	Ø25 h45	8	BT 218	Ø35 h50	18
BT 209	Ø25 h45	9	BT 220	Ø35 h47	20
BT 210	Ø30 h50	10	BT 222	Ø35 h47	22
BT 211	Ø30 h50	11	BT 224	Ø35 h43	24



cod.	size	#	cod.	size	#
BS 102	Ø25 h50	2	BS 112	Ø30 h50	12
BS 103	Ø25 h50	3	BS 113	Ø30 h50	13
BS 104	Ø25 h50	4	BS 114	Ø35 h55	14
BS 105	Ø25 h50	5	BS 115	Ø35 h50	15
BS 106	Ø25 h45	6	BS 116	Ø35 h50	16
BS 107	Ø25 h50	7	BS 117	Ø35 h50	17
BS 108	Ø25 h45	8	BS 118	Ø35 h50	18
BS 109	Ø25 h40	9			
BS 110	Ø30 h50	10			
BS 111	Ø30 h50	11			



cod.	size	#	cod.	size	#
BC 320	Ø25 h47	2	BF 310	Ø25 h45	4
BC 321	Ø25 h47	3	BF 311	Ø25 h45	6
BC 322	Ø25 h47	4	BF 312	Ø25 h45	7
BC 323	Ø25 h47	5	BF 313	Ø25 h45	9
BC 324	Ø25 h43	6	BF 314	Ø30 h50	10
BC 325	Ø35 h50	7	BF 314/11	Ø30 h50	11
BC 326	Ø30 h45	8	BF 315	Ø30 h45	12
BC 327	Ø30 h50	9	BF 316	Ø30 h45	13
BC 328	Ø35 h53	10	BF 317	Ø35 h50	15
BC 329	Ø35 h50	11	BF 318	Ø35 h50	16
BC 330	Ø35 h50	12	BF 319	Ø35 h50	18



cod.	size	#
BX 9017	Ø30 h50	20
BX 9022	Ø30 h45	20



cod.	size	#
BR 330	Ø30 h50	15
BR 331	Ø30 h45	18
BR 332	Ø35 h50	20



cod.	size	#
BA 411	Ø30 h50	15
BA 413	Ø30 h47	17
BA 415	Ø35 h53	20



cod.	size	#
BD 300	Ø25 h40	17
BD 301	Ø30 h43	20
BD 302	Ø35 h45	27



cod.	size	#
BX 2312	Ø25 h33	12
BX 2314	Ø25 h40	12
BX 2315	Ø30 h45	14



cod.	size	#
BX 1105	Ø25 h40	18
BX 1115	Ø25 h50	18
BX 1123	Ø25 h40	16
BX 1132	Ø25 h40	14



cod. size #
BX 1906 Ø35 h45 12



cod. size #
BX 1013 Ø25 h43 13



cod. size #
BX 2013 Ø25 h40 13



cod. size #
BX 3005 Ø35 h50 5



cod. size #
BX 4014 Ø25 h45 14



cod. size #
BX 5017 Ø30 h40 15



cod. size #
BX 6018 Ø30 h45 18



cod. size #
BX 7020 Ø30 h45 18



cod. size #
BX 8019 Ø17 h28 9



cod. size #
BX 1405 Ø25 h40 20



cod. size #
BX 1510 Ø30 h45 13



cod. size #
BX 1217 Ø25 h37 18



cod. size #
BX 1303 Ø25 h40 16



cod. size #
BX 1820 Ø30 h42 5



cod. size #
BX 2117 Ø25 h40 1



cod. size #
BX 1605 Ø25 h45 8



cod. size #
BX 1713 Ø25 h40 2



cod. size #
BX 2219 Ø30 h40 2



cod. size #
BC 0855 Ø30 h45 Ø20



cod. size #
BX 0108 Ø25 h40 Ø13



cod. size #
BX 0134 Ø25 h42 15



cod. size #
BX 0158 Ø25 h45 15



cod. size #
BX 0190 Ø25 h43 Ø12



cod. size #
BX 0250 Ø30 h37 Ø20



cod. size #
BX 0252 Ø30 h40 Ø18



cod. size #
BX 0510 Ø25 h40 Ø14



cod. size #
BX 0120 Ø24 h43 13
BX 0123 Ø24 h40 17



cod. size #
BX 0116 Ø25 h40 15
BX 0119 Ø25 h40 20



cod. size #
BS 0D6K Ø25 h42 Ø10
BS 0F6K Ø30 h45 Ø18



cod. size #
BS 0195 Ø25 h40 Ø12
BS 0195K Ø25 h40 Ø14



cod. size #
BF 0867 Ø35 h50 Ø16
BF 0869 Ø35 h48 Ø20

IMBUTINI - FUNNELS

Bocchette ad imbutino in acciaio inox ideale per riempire cannoli etc...

kit composto da 5 bocchette.

Stainless steel funnel-shaped piping tips to stuff cannoli, etc.

kit composed of 5 piping tips.



cod. size #
BIM 232 Ø25 h95 Ø8



cod. size #
BIM 340 Ø25 h90 Ø4



Cod. **50AD001**

Adattatore piccolo per bocchette con base 18mm
Small piping tip adapter with 18mm base



Cod. **50AD002**

kit 2 pcs
Adattatore medio per bocchette con base 25mm - 31mm
Medium piping tip adapter with 25mm - 31mm base



Cod. **50AD003**

Adattatore grande per bocchette con base 36mm
Large piping tip adapter with 36mm base

SET BOCCHETTE - PIPING TIPS SET

Set speciale composto da 10 pz bocchette in acciaio inox di differenti misure.
10 stainless steel piping tips kit of different sizes.



Cod. **BS 10 T**

Ø 4 - 5 - 6 - 7 - 8 - 9 - 10 - 12 - 13 - 15 mm



Cod. **BS 10 S**

Ø 4 - 5 - 6 - 7 - 8 - 9 - 10 - 12 - 13 - 15 mm



Cod. **BOS 52**

Bocchette in acciaio ideali per decorazioni
Stainless steel piping tips box ideal for decorations
Box 52 pcs



Cod. **BOS 26**

Bocchette in acciaio ideali per decorazioni
Stainless steel piping tips box ideal for decorations
Box 26 pcs



Cod. **BOS 36 BIG**

Bocchette in acciaio ideali per decorazioni
Stainless steel piping tips box ideal for decorations
Box 36 pcs



Cod. BOS 24

Bocchette in policarbonato ideali per decorazioni
Polycarbonate piping tips ideal for decorations
Box 24 pcs



Cod. BOS 60

Bocchette in policarbonato ideali per decorazioni
Polycarbonate piping tips ideal for decorations
Box 60 pcs



Cod. BBP1

Bocchette in policarbonato
Polycarbonate piping tips
Box 12 pcs



Cod. BBP2

Bocchette in policarbonato
Polycarbonate piping tips
Box 12 pcs



Cod. BBP3

Bocchette in policarbonato
Polycarbonate piping tips
Box 24 pcs



Cod. **BOSPL1**
Bocchette in plastica
Plastic piping tips
Box 12 pcs



Cod. **BOSPL2**
Bocchette in plastica
Plastic piping tips
Box 12 pcs



Cod. **BOSPL3**
Bocchette in plastica
Plastic piping tips
Box 20 pcs



Cod. **BOSPL4**
Bocchette in plastica
Plastic piping tips
Box 20 pcs



Cod. **BPL6**
Bocchette in plastica
Plastic piping tips
Box 6 pcs

CHIODI IN ACCIAIO - FLOWER NAILS

Set di chiodi in acciaio inox per realizzare fiori o piccole decorazioni di torte.
Stainless steel flower nails set for small cake decorations.



Cod. **FLOWER 1**
20 mm - pack 24 pcs



Cod. **FLOWER 3**
35 mm - pack 24 pcs



Cod. **FLOWER 4**
33 mm - pack 24 pcs



Cod. **FLOWER 5**
40 mm - pack 24 pcs



Cod. **FLOWER 6**
36 mm - pack 24 pcs



Espositore in plastica per bocchette.
Plastic wall rack for piping tips.

cod. **ESPO** 27x25 cm - 24 sedi



Espositore per bocchette e sac a poche.
Wall rack for piping tips and pastry bags.

cod. **ESPO B** bianco/white
cod. **ESPO ST** inox/st steel



Cod. **BRU**
Bruschino per la pulizia delle bocchette.
Brush for piping tips cleaning.

BAKING EQUIPMENT

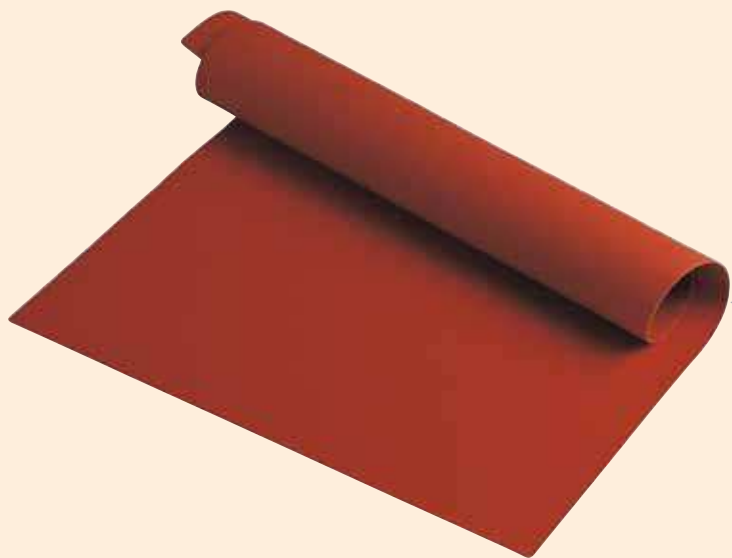

Tappeti antiaderenti in silicone per cottura e surgelazione di qualsiasi prodotto alimentare.
Non-stick silicon mats for baking and freezing every kind of food.

cod. **SILICOPAT1/R** 395x595mm
cod. **SILICOPAT2/R** 310x510mm
cod. **SILICOPAT5/R** 270x420mm
cod. **SILICOPAT6/R** 360x430mm
cod. **SILICOPAT7/R** 300x400mm

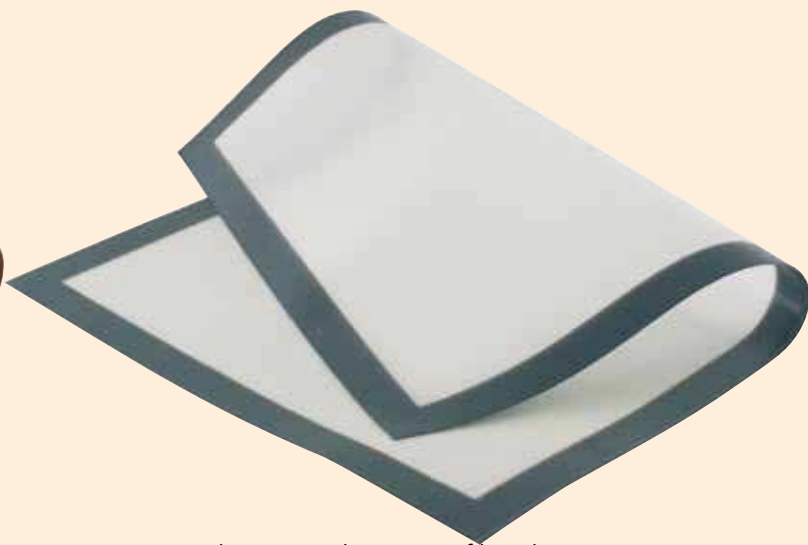

Tappeti antiaderenti in silicone con fibra di vetro per cottura e surgelazione di qualsiasi prodotto alimentare.

Ideali per la lavorazione dello zucchero.

Non-stick silicon mats with glass fibres for baking and freezing every kind of food. **Ideal to work with sugar.**

cod. **SILICOPAT 1/B** 595x395mm
cod. **SILICOPAT 2/B** 310x510mm
cod. **SILICOPAT 3/B** 620x420mm
cod. **SILICOPAT 4/B** 790x590mm



Cod. **TEFLONPAT**

Tappetino antiaderente in teflon.

Non stick teflon mat.

60x40 cm



Cod. **51CF6040**

Carta forno professionale resistente ai grassi e all'umidità.

Professional baking paper, greaseproof and humidity resistant.

60x40 cm - Pack 500 pcs



Teglia lamiera alluminata
con quattro bordi spessore 0,8
Baking tray made of aluminized sheet
with four edges 0,8 thick

cod. **53TL60404** 60x40 h2 cm
cod. **53TL60804** 60x80 h2 cm

Teglia lamiera alluminata
con due bordi spessore 0,8
Baking tray made of aluminized sheet
with two edges 0,8 thick

cod. **53TL60402** 60x40 h2 cm
cod. **53TL60802** 60x80 h2 cm



Teglia in alluminio
con quattro bordi spessore 1,5
Aluminium baking tray
with four edges 1,5 thick

cod. **53TA60404** 60x40 h2 cm
cod. **53TA60804** 60x80 h2 cm

Teglia in alluminio
con due bordi spessore 1,5
Aluminium baking tray
with two edges 1,5 thick

cod. **53TA60402** 60x40 h2 cm
cod. **53TA60802** 60x80 h2 cm



Teglia in alluminio forata
con quattro bordi spessore 1,5
Flat perforated aluminium baking tray
with four edges 1,5 thick

cod. **53TAF60404** 60x40 cm
cod. **53TAF60804** 60x80 cm

Servizio teflonatura su richiesta
On demand tefloning service

Stampi cannolo - Cannoli moulds



Stampi in acciaio per la produzione di cannoli.
Stainless steel mould to make cannoli.

cod. CI22X140	22x140mm	6 pcs
cod. CI16X200	16x200mm	6 pcs
cod. CI12X200	12x200mm	6 pcs



Stampi in acciaio per la produzione di cannoli.
Stainless steel mould to make cannoli.

cod. CO30X120	30x120mm	6 pcs
cod. CO35X140	35x140mm	6 pcs
cod. CO40X160	40x160mm	6 pcs



Cod. **CANNOLO**
Speciale materiale plastico utilizzabile in forno.
Special plastic material which can be used into the oven.
30x120mm
Pack 10 pcs

Guanti e presine - Gloves and pot holders



Cod. **GL1**
250°C
Omologati CE.
CE approved.



Cod. **GL2**
250°C
Omologati CE.
CE approved.



Cod. **GL3**
250°C
Omologati CE.
CE approved.



Cod. **GL10**
100% cotone - cotton
27x15cm



Cod. **GL11**
100% cotone - cotton
34x15cm



Cod. **GL25PRE**
25x35cm

Cod. **GL18PRE**
18x25cm

GRADUATED BOTTLES AND SMALL CONTAINERS



Cod. **50FL00C**
Flacone rettangolare con copritappo
Rectangular bottles with cover cap
100x56 - h275 mm
1000ml



Cod. **50PF00**
Porta Flacone - Bottle holder
238x110 h 128 mm

Cap. 4 cod. 50FL00C
Flaconi non inclusi - Bottles not included

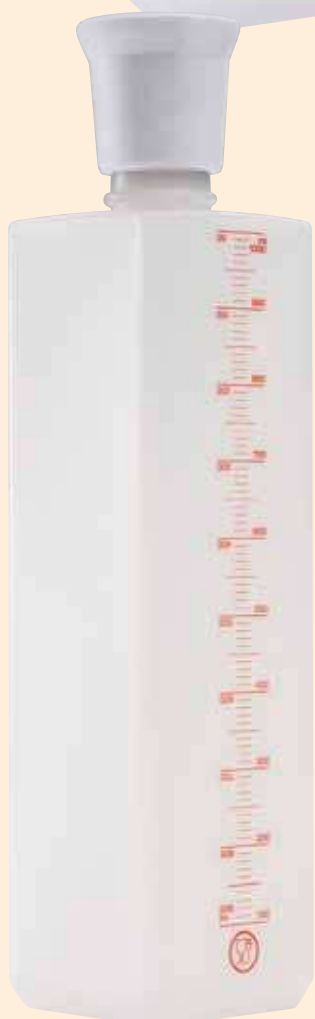

Cod. **FLACONE**
70x70 - h270 mm
1000ml



Cod. **PORTFLACONE**
Porta Flacone - Bottles holder
250x110 h 80 mm

Cap. 3 cod. FLACONE
Flaconi non inclusi - Bottles not included

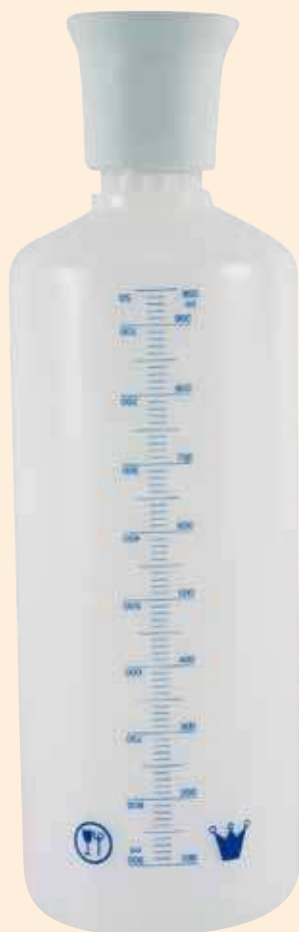

Cod. **FLAN1**
Ø85 - h250 mm
1000ml



Cod. **BO1000N**
1000ml



Cod. **BO500N**
500ml



Cod. **BO250N**
250ml



Cod. **BO100N**
100ml



Cod. **CONDISPENSER**

70x35 h11 cm1000ml

Pratico dispenser porta granelle, farine, frutta, condimenti vari.

L'interno è suddiviso da 4 vaschette da 2Lt cadauna. Realizzato in materiale plastico resistente.

Practical dispenser for pips, flour and other products.

It is composed of 4 dispensers of 2Lt each, and made of strong plastic material.



Caraffe in plastica bianca con scala graduata in rilievo.
White plastic carafes with embossed graduated scale.

cod. **CF1** 1000ml
cod. **CF2** 2000ml
cod. **CF3** 3000ml
cod. **CF5** 5000ml



Caraffe in plastica bianca con scala graduata in rilievo.
White plastic carafes with embossed graduated scale.

cod. **52CF01PP** 500ml
cod. **52CF02PP** 1000ml
cod. **50CF03PP** 2000ml
cod. **50CF04PP** 3000ml
cod. **50CF05PP** 5000ml



Caraffe graduate in plastica trasparente.
Transparent plastic graduated carafes.

cod. **CFTRA1** 500ml
cod. **CFTRA2** 1000ml
cod. **CFTRA3** 2000ml
cod. **CFTRA4** 3000ml



Secchi in plastica con becco e scala graduata.
Plastic buckets with lip and graduated scale.

cod. **50SE09PEB** 900ml
cod. **50SE12PEB** 1200ml
cod. **50SE15PEB** 1500ml



Bol in Policarbonato trasparente.

No microonde.

Transparent polycarbonate bowls.

No microwave.

Bol in Polipropilene bianco.

No microonde.

White polypropylene bowls.

No microwave.

cod. 52B013PC	Ø 13	400 ml
cod. 52B017PC	Ø 17	1000 ml
cod. 52B023PC	Ø 23	2500 ml
cod. 52B028PC	Ø 28	4000 ml
cod. 52B032PC	Ø 32	8000 ml
cod. 52B038PC	Ø 38	10000 ml

cod. 52B013PP	Ø 13	400 ml
cod. 52B017PP	Ø 17	1000 ml
cod. 52B023PP	Ø 23	2500 ml
cod. 52B028PP	Ø 28	4000 ml
cod. 52B032PP	Ø 32	8000 ml
cod. 52B038PP	Ø 38	10000 ml



Sessole in plastica

Plastic scoops

cod. SES 100	125ml
cod. SES 250	250ml
cod. SES 500	512ml
cod. SES 800	857ml
cod. SES 1500	1520ml



Sessole in plastica

Plastic scoops

cod. 54SE19PP	19 cm
cod. 54SE24PP	24 cm
cod. 54SE29PP	29 cm
cod. 54SE34PP	34 cm
cod. 54SE38PP	38 cm
cod. 54SE42PP	42 cm

PLEXIGLASS DISPLAYS



Porta brioches in plexiglass
Plexiglass showcases for croissants

cod. **VB00102** 60x37cm - h36cm



Porta brioches in plexiglass
Plexiglass showcases for croissants

cod. **VB00103** 50x33cm - h53cm
cod. **VB00104** 67x40cm - h53cm



Porta brioches in plexiglass con led
Plexiglass showcase with led lights

cod. **VB00308** 39,5x32,5cm - h50,5cm



Porta brioches in plexiglass colorato
Plexiglass showcases for croissants

cod. **VB00200** 42x31cm - h42,5cm Bianco - White
cod. **VB00201** 42x31cm - h42,5cm Trasp. - Trans.
cod. **VB00202** 42x31cm - h42,5cm Verde - Green
cod. **VB00203** 42x31cm - h42,5cm Arancio - Orange
cod. **VB00206** 42x31cm - h42,5cm Satinato - Glazed
cod. **VB00208** 42x31cm - h42,5cm Nero - Black



Porta brioches in plexiglass
Plexiglass showcases for croissants

cod. **VB00408** 37x31cm - h31cm



Porta brioches in plexiglass
Plexiglass showcases for croissants

cod. **VB00306** 41x36,5cm - h44cm



Vetrina porta brioches riscaldante
Warming showcases for croissants

cod. **VB00105** 53x37cm - h50cm
cod. **VB00106** 72x37cm - h50cm

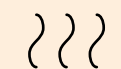

Vetrine porta brioches riscaldanti
Warming showcases for croissants

cod. **VB00108** 35x49,5 h 33 cm 1 piano-shelv
cod. **VB00110** 35x49,5 h 39 cm 2 piani-shelves



Vetrine porta brioches base acciaio
Warming showcases with steel base

cod. **VB00107** 35x49,5 h 33 cm 1 piano-shelv
cod. **VB00109** 35x49,5 h 39 cm 2 piani-shelves

Parafiato in plexiglass
Plexiglass food shields

cod. **AR0001** 49,5x30cm - h27cm
cod. **AR00011** 99,5x30cm - h27cm



Parafiato in plexiglass
Plexiglass food shields

cod. **AR02801** 49,5x31cm - h27cm



Vassoi in plexiglass
Plexiglass trays

cod. **VS00101** 47x34cm - h5cm



Vassoi in plexiglass
Plexiglass trays

cod. **VS00201** 42x30cm - h6,5cm

Vassoi in plexiglass
Plexiglass trays
Misure - size: 145 x 400 h 20 mm

cod. **50VP0100** Bianco - White
cod. **50VP0103** Arancio - Orange
cod. **50VP0108** Nero - Black
cod. **50VP0111** Verde - Green
cod. **50VP0112** Giallo - Yellow
cod. **50VP0117** Lilla - Lilac



Vassoi in plexiglass
Plexiglass trays
Misure - size: 145 x 289 h 20 mm

cod. **50VP0200** Bianco - White
cod. **50VP0203** Arancio - Orange
cod. **50VP0208** Nero - Black
cod. **50VP0211** Verde - Green
cod. **50VP0212** Giallo - Yellow
cod. **50VP0217** Lilla - Lilac



Vassoi in plexiglass
Plexiglass trays
Misure - size: 204 x 258 h 20 mm

cod. **50VP0300** Bianco - White
cod. **50VP0303** Arancio - Orange
cod. **50VP0308** Nero - Black
cod. **50VP0311** Verde - Green
cod. **50VP0312** Giallo - Yellow
cod. **50VP0317** Lilla - Lilac



Vassoi in plexiglass
Plexiglass trays
Misure - size: 294 x 394 h 20 mm

cod. **50VP0400** Bianco - White
cod. **50VP0403** Arancio - Orange
cod. **50VP0408** Nero - Black
cod. **50VP0411** Verde - Green
cod. **50VP0412** Giallo - Yellow
cod. **50VP0417** Lilla - Lilac



MACARON DISPLAYS

Espositori per macaron Ø45mm
Macaron displays for Ø45mm

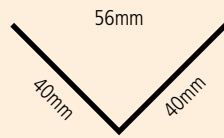

cod. **AG05801** 315x325 h65 mm TRANSPARENT



cod. **AG05800** 315x325 h65 mm BIANCO-WHITE



cod. **AG05700** 460x330 h145 mm BIANCO-WHITE
cod. **AG05701** 460x330 h145 mm TRANSPARENT



cod. **AG05600** 270x330 h145 mm BIANCO-WHITE
cod. **AG05601** 270x330 h145 mm TRANSPARENT



cod. **AG07801** 270x150 h480 mm TRANSPARENT cap. 25 pcs



cod. **AG07901** 350x350 h450 mm TRANSPARENT cap. 60 pcs



cod. **AG07701** Ø280 h430 mm TRANSPARENT cap. 62 pcs



cod. **AG07701P** Ø240 h 280 mm TRANSPARENT cap. 30 pcs



cod. **AG08201** 400x350 h280 mm TRANSPARENT cap. 15/18 pcs



cod. **AG08001** 450x60 h60 mm TRANSPARENT cap. 7 pcs



cod. **AG08101** 55x350 h600 mm TRANSPARENT cap. 9 pcs

SUGAR EQUIPMENT

Adatta per la lavorazione dello zucchero.
Realizzata interamente in metallo colorato.
Dotata di regolazione a 3 livelli:
600 - 1200 e 1800W.
Piano di lavoro cm 64x50.
Dotata di cavo elettrico.

Suitable for sugar creations.
Made of coloured metal.
3 settings: 600 - 1200 - 1800W.
Working table cm 64x50.
Electric cable included.



Cod. **LAMP**
Lampada - Lamp

Cod. **LAMPLEX**
paratia antivento / shelter



Cod. **POMP**
Pompetta
Sugar pump



Cod. **MRTE**
Supporto per termometro
Thermometer holder
h13,7cm



Cod. **MTE**
Termometro
Thermometer
da +80°C a +200°C
h30cm



Cod. **MCAR**
Caramellizzatore
Caramelizer
230V/50Hz



Cod. **CANNELLO PRO**



Cod. **CANNELLOBL**



Cod. **CANNELLOBIG**

Cannelli con accensione elettronica a fiamma regolabile. Pratici da tenere in mano. Indispensabile per tutti i lavori di incollaggio dello zucchero e per: Crème Brûlée, torta di ricotta, meringa, sculture in ghiaccio, crostata di frutta. **Cartuccia non inclusa.**

Mini torchs with automatic ignition and adjustable flame. Easy to use. Necessary for gluing sugar works and also for: Crème brûlée, cheese cakes, meringue cakes, ice sculptures, fruit tarts. **Cartridge not included.**

Guanti in lattice ideali nella lavorazione dello zucchero. Latex gloves to work with sugar.



- cod. **GL 6** 6 - 6 1/2
- cod. **GL 7** 7 - 7 1/2
- cod. **GL 8** 8 - 8 1/2
- cod. **GL 9** 9 - 9 1/2

PASTRY EQUIPMENT

Frusta inox con manico ergonomico e pratico in materiale plastico (exoglass). Lavabile fino a 220°C.
Stainless steel whisk with ergonomic handle (exoglass), heat resistant up to 220°C .

cod. MFRU25	25cm
cod. MFRU30	30cm
cod. MFRU35	35cm
cod. MFRU40	40cm
cod. MFRU45	45cm
cod. MFRU50	50cm

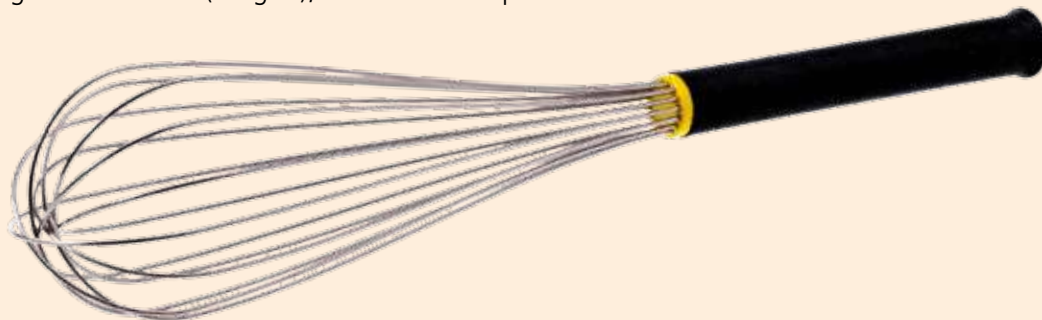

Frusta inox con manico in plastica provvista di gancio per appenderla.
Stainless steel whisk with plastic handle and hook to be hanged.

cod. TFRU25	25cm
cod. TFRU30	30cm
cod. TFRU35	35cm
cod. TFRU40	40cm
cod. TFRU45	45cm
cod. TFRU50	50cm



Robusta frusta con manico inox, spessore fili 2,3mm ideale per impasti pesanti.
Strong st. steel whisk with st. steel handle and wires 2,3mm for heavy mixtures.

cod. BFRU25	25cm
cod. BFRU30	30cm
cod. BFRU35	35cm
cod. BFRU40	40cm
cod. BFRU45	45cm
cod. BFRU50	50cm



Pinze - Pincers



Cod. **PINZAX1**
Pinze in acciaio inox
St. Steel pincers
190x17mm



Cod. **PINZAX2**
Pinze in acciaio inox
St. Steel pincers
190x36mm



Cod. **PINZAX3**
Pinze in acciaio inox
St. Steel pincers
190x38mm



Cod. **PINZAX4**
Pinze in acciaio inox
St. Steel pincers
190x58mm

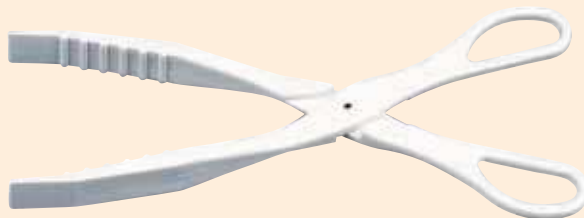

Cod. **PINZA**
Pinza in plastica
Plastic pincer

Cappelli monouso in carta - Disposable paper hats



Cod. **CAP 1**
Regolabile - Adjustable
10 pcs - h 210 mm



Cod. **CAP 2**
Regolabile - Adjustable
10 pcs - h 250 mm



Cod. **CAP 3**
Regolabile - Adjustable
10 pcs - h 200 mm

Cod. **CAP 1B**
Regolabile (Versione Economica)
Adjustable (Economic version)
10 pcs - h 210 mm

Cod. **CAP 2B**
Regolabile (Versione Economica)
Adjustable (Economic version)
10 pcs - h 250 mm

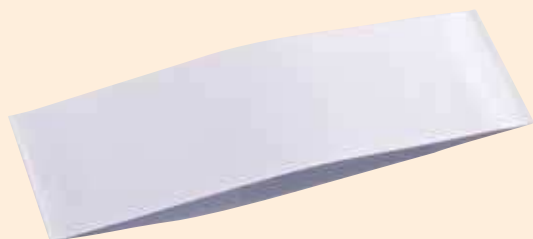

Cod. **CAP 4**
25 pcs - 280x h85mm

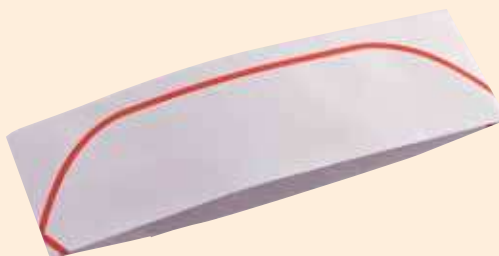

Cod. **CAP 5**
25 pcs - 275x h80 mm

Raschietti in plastica - Plastic scrapers

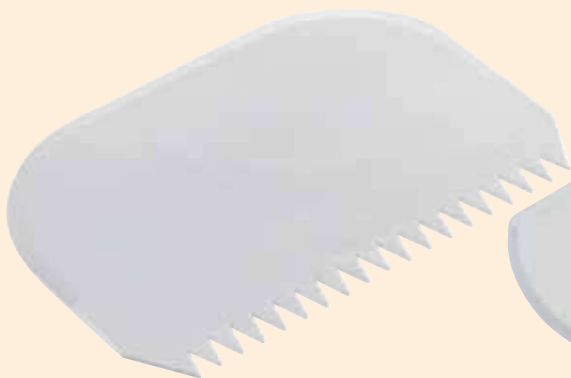

cod. **RTD 1** 145x95mm rigido / rigid



cod. **RTF 1** 150x110mm rigido / rigid
cod. **RTF 2** 150x110mm morbido / soft



cod. **RTL 1** 145x95mm rigido / rigid
cod. **RTL 2** 145x95mm morbido / soft



cod. **RTP 1** 120x90mm rigido / rigid
cod. **RTP 2** 120x90mm morbido / soft



cod. **RTA 1** 125x90mm rigido / rigid
cod. **RTA 2** 125x90mm morbido / soft



cod. **RTO 1** 140x90mm rigido / rigid
cod. **RTO 2** 140x90mm morbido / soft



cod. **RTV 1** 150x150mm rigido / rigid
cod. **RTV 2** 150x150mm morbido / soft



cod. **RTT 1** 215x130mm rigido / rigid



cod. **RTS 1** 195x150mm rigido / rigid

Raschietti in acciaio - Steel scrapers

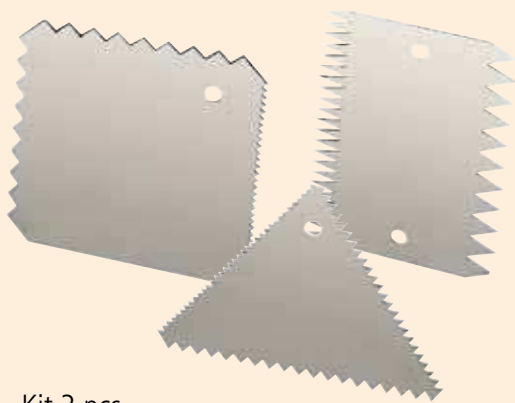

Kit 3 pcs

cod. **INOX 3** 100x100mm



cod. **RD105** 105x105mm
 cod. **RD125** 125x105mm
 cod. **RD150** 150x105mm
 cod. **RD175** 175x105mm



cod. **RAS 1** 130X100mm
 cod. **RAS 2** 175X100mm



cod. **RAS 3** 145X195mm



cod. **RAS 4** 145X170mm
 cod. **RAS 5** 245mm
 cod. **RAS 6** 295mm



cod. **RAS 7** 120mm
 cod. **RAS 8** 200mm

Pennelli professionali - Professional pastry brushes

Robusto pennello
con manico in plastica
e **setola naturale** lunga 55mm.
Strong pastry brushes
with plastic handle
and **natural bristle** 55mm.

cod. **PEM20** 20mm
cod. **PEM30** 30mm
cod. **PEM40** 40mm
cod. **PEM50** 50mm
cod. **PEM60** 60mm
cod. **PEM70** 70mm



Robusto pennello
con manico in plastica
e **setola sintetica** lunga 70mm.
Strong pastry brushes
with plastic handle
and **synthetic bristle** 70mm.

cod. **PEMS20** 20mm
cod. **PEMS30** 30mm
cod. **PEMS40** 40mm
cod. **PEMS50** 50mm
cod. **PEMS60** 60mm
cod. **PEMS70** 70mm



Spazzole per la pulizia - Cleaning brushes

Cod. **SPZ SE**
400x40 mm
Temp. MAX 90° C



Cod. **SPZ INOX**
145x55 mm



Cod. **SPZ PL1**
210x65 mm
Temp. MAX 130° C



Cod. **SPZ PL2**
240x75 mm
Temp. MAX 130° C



Cod. **SPZ PL3**
400x40 mm
Temp. MAX 130° C



Teglia forata - Plastic pan

Teglie in materiale plastico forate di vari diametri. Indispensabile per preparare fondi rotondi per dolci senza spreco. Spessore 8 mm. - Misure: 59x39 cm.

Plastic pans with circles of different diameters. Ideal to prepare round base sponge cakes without any waste. Thickness 8 mm. Size: 59x39 cm.

cod. TFP8	Ø80mm	8 dischi-circles
cod. TFP10	Ø100mm	8 dischi-circles
cod. TFP12	Ø120mm	8 dischi-circles
cod. TFP14	Ø140mm	8 dischi-circles
cod. TFP16	Ø160mm	6 dischi-circles
cod. TFP18	Ø180mm	6 dischi-circles
cod. TFP20	Ø200mm	4 dischi-circles
cod. TFP22	Ø220mm	3 dischi-circles
cod. TFP24	Ø240mm	2 dischi-circles
cod. TFP26	Ø260mm	2 dischi-circles



Setacci - Sieves

Setacci in acciaio inox per farina.
Stainless steel sieves for flour.

cod. SETAC16	Ø160mm
cod. SETAC19	Ø190mm
cod. SETAC21	Ø210mm
cod. SETAC24	Ø240mm
cod. SETAC26	Ø260mm
cod. SETAC28	Ø280mm
cod. SETAC30	Ø300mm



Stampo decora crostate Cutter for tarts

Cod. **DECOR 30**
Ø300 mm

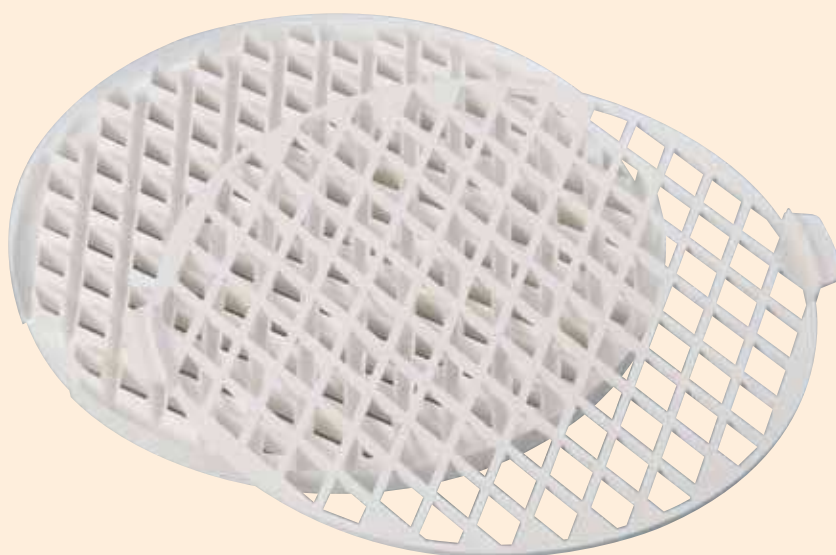

Telai in plastica - Plastic frames

Telaio per stesura biscuit, cioccolato e altri impasti.
Frame to spread biscuit, chocolate and other doughs.
Misura esterna - External Size: 67x47 cm

cod. **TL 02** 570x370 h 2 mm
cod. **TL 03** 570x370 h 3 mm
cod. **TL 04** 570x370 h 4 mm
cod. **TL 05** 570x370 h 5 mm



Telaio inox - St steel frame

Telaio inox per Charlotte.
St. steel frame for Charlotte.
Misura esterna - External Size: 59x39 cm

cod. **TL 15** 580x380 h 15 mm

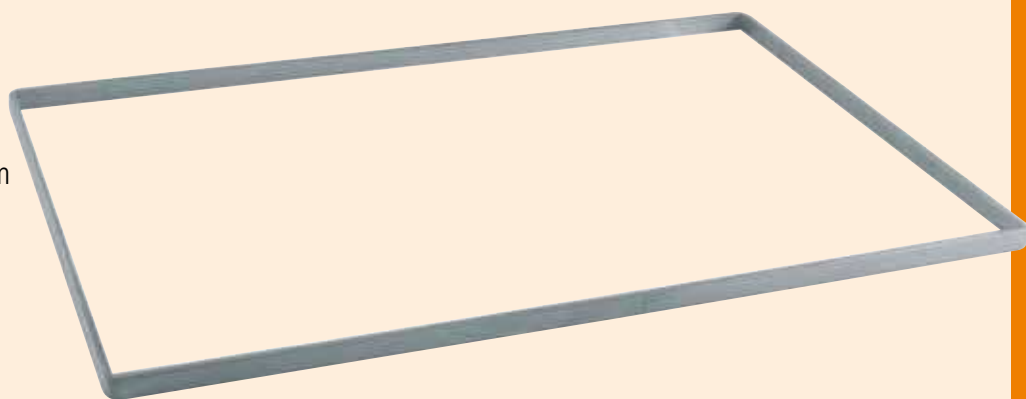

Racle in plastica - Plastic spatulas

Spatola biscuit. - Knife for biscuit.

cod. **SPB** 555 h80mm

cod. **CSMSPB60**
cod. **CSMSPB40**
cod. **SPBMINI**



Racla inox - St. Steel tool

Racla inox che permette la stesura uniforme
con possibilità di regolare lo spessore dell'im-
pasto.

St. steel tool that allows to spread uniformly
different doughs, adjusting the
thickness.

cod. **SPB SPECIAL** 500x180 h60mm

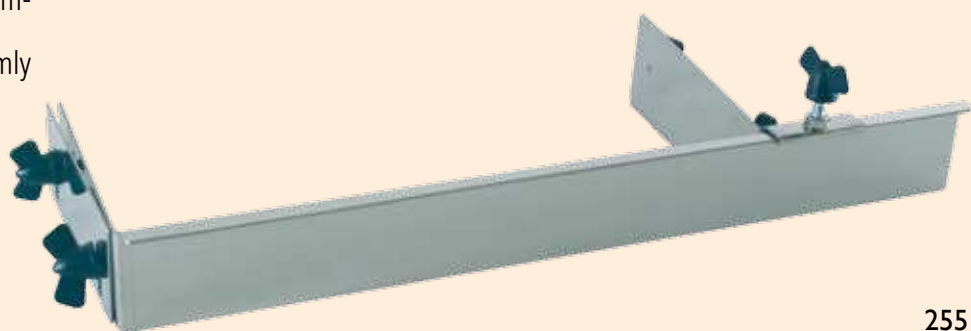

Porzionatori - Cake markers

Porzionatori in plastica o in acciaio, utilizzabili in entrambi i lati ideali per dividere in modo uniforme le torte.
Plastic and stainless steel double face cake markers.

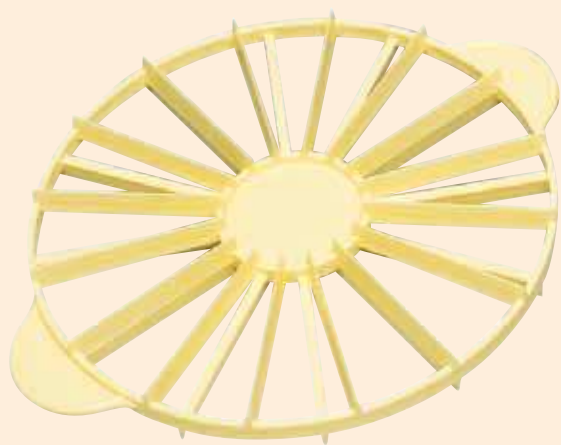

cod. **PPT 8/12** fette - slices: 8-12
cod. **PPT 12/16** fette - slices: 12-16
cod. **PPT 14/16** fette - slices: 14-16
cod. **PPT 12/18** fette - slices: 12-18
cod. **PPT 14/18** fette - slices: 14-18
cod. **PPT 12** fette - slices: 12



cod. **PPT 8X** fette - slices: 8
cod. **PPT 10X** fette - slices: 10
cod. **PPT 12X** fette - slices: 12
cod. **PPT 14X** fette - slices: 14
cod. **PPT 16X** fette - slices: 16
cod. **PPT 18X** fette - slices: 18

Ripiani girevoli - Turning cake stands



Cod. **GIRA**
Ø32 h10cm



Cod. **GIRA2**
Ø31 h5,5cm



Cod. **GIRA3**
41x31 h9,5cm
Acciaio



Cod. **40-W125**
Ø23 h14cm
Inclinabile - Tilting

Cornice speciale - Special frame

Strumento ideale per la produzione di dessert.
I vari componenti permettono di calibrare lo spessore della crema o di altri prodotti in modo uniforme.

Set composto da:

1 telaio in plastica senza fondo

1 piatto PST liscio

1 piatto PST ondinato

2 spatole livellatrici

Ideal mould to produce desserts. Thanks to the different parts it is possible to calibrate the thickness of the cream and other products.

Set composed of:

1 Saucepan without bottom

1 Corrugated PST tray

1 Smooth PST tray

2 Equalizing plastic spatulas

Cod. **CREAM1**

60x40 h 5 cm



HOW TO USE



Spruzzare le ondinato con lo staccante Martellato cod. COATING

1 - Per l'effetto ondinato mettere la placca ondinato all'interno e procedere con i vari strati.

Versare il prodotto sulla teglia e stendere con la spatola più profonda.

2-3 - Ripetere l'operazione altre due volte versando e stendendo l'impasto con l'aiuto della spatola livellatrice (tra uno strato e l'altro di impasto potete inserire del biscuit).

Congelare in abbattitore o freezer a -20 °C al cuore. Estrarre e capovolgere il dessert ancora congelato.

Sprinkle the corrugated surface with the detaching spray Martellato Cod. COATING

1 - To obtain the corrugated effect, turn the tray and proceed with the various layers.

2-3 - Repeat two more times by pouring and spreading the dough with the help of the spatula (between each layer of dough you can put the biscuit).

Place into the freezer or in blast chiller at -20 °C (inside cake temperature).

Remove and reverse the frozen cake.

Pallinatore Ball machine

Strumento ideale per la produzione di "Baci di Dama", praline e palline di marzapane.
Special plastic machine to produce "Lady's Kisses", pralines and marzipan balls.

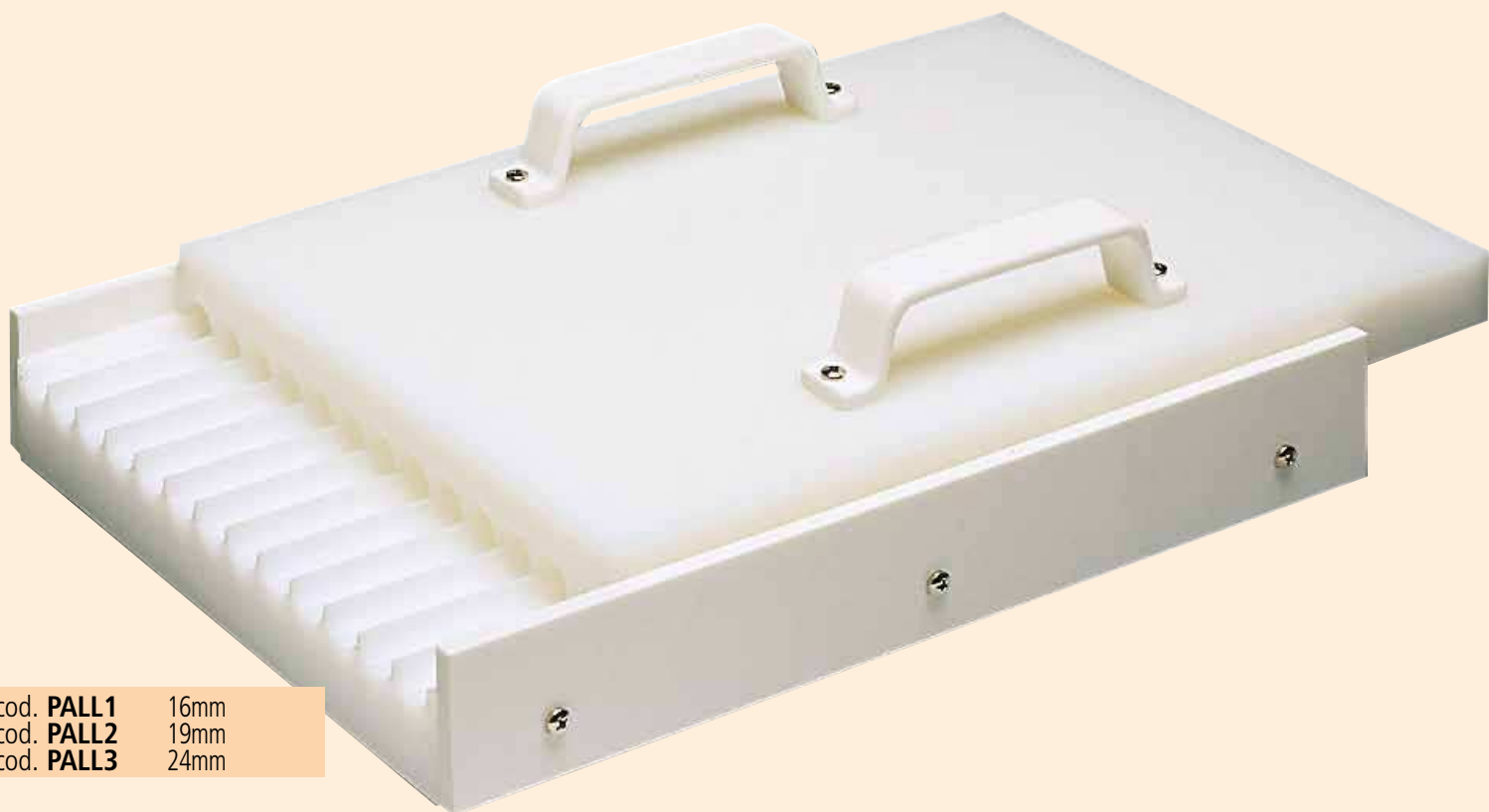

cod. PALL1	16mm
cod. PALL2	19mm
cod. PALL3	24mm

HOW TO USE

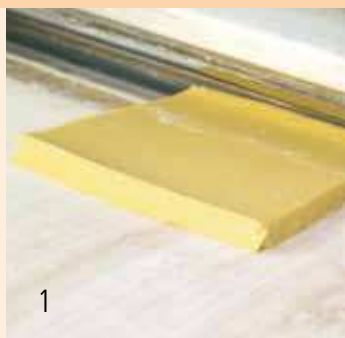

1

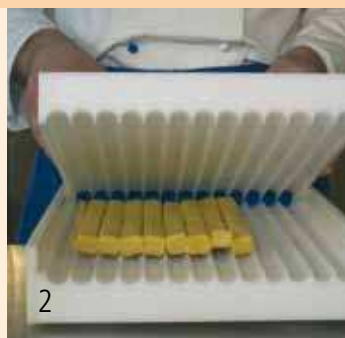

2



3

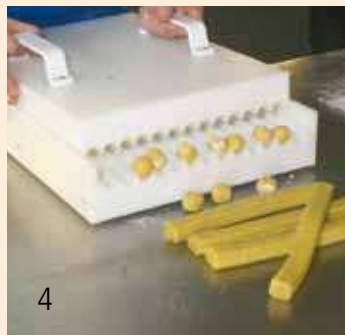

4

- 1 - Preparare la pasta stesa alla stessa altezza del foro del pallinatore (16 o 19 o 24mm).
- 2 - Posizionarla alla base del pallinatore e premere con la parte superiore verso il basso fino a formare delle strisce di pasta.
- 3 - Posizionare manualmente in modo orizzontale le strisce di pasta.
- 4 - Premere nuovamente il coperchio verso il basso facendolo scorrere al fine di produrre le palline.

- 1 - Prepare the dough with the same thickness of the holes of your ball machine (16 or 19 or 24mm).
- 2 - Set the dough on the base of you ball machine and press with the cover to obtain strips.
- 3 - Lay the strips of dough horizontally.
- 4 - Press the cover up and down in order to obtain balls.

Grignottina Cookies maker

Per ottenere "Grignottines" o "Brutti ma Buoni" con riso soffiato, pezzi di mandorla, nocciola, cioccolato temperato e burro cacao.

Composto da:

1 telaio in plastica senza fondo

2 teglie forate (Ø30 - 40 mm)

1 spatola in plastica

Machine for crispy cookies with puffed rice, almonds, nuts, chocolate and cocoa-butter.

Composed of:

1 Plastic saucepan without bottom

2 Perforated trays (Ø30 - 40 mm)

1 Plastic spatula

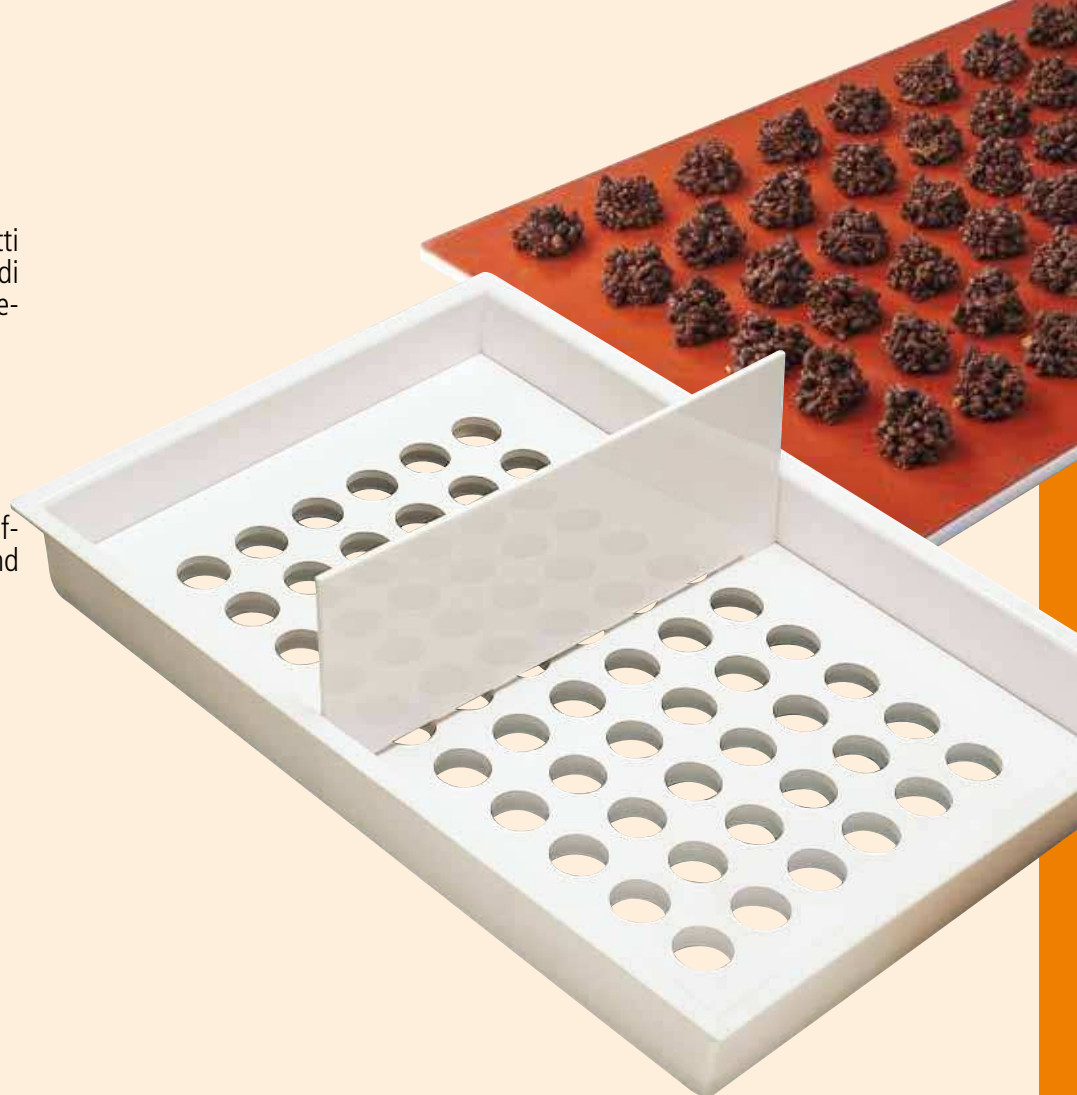

cod. **CIOK 1** 60x40 h5cm

HOW TO USE

1 - Versare e stendere l'impasto nella teglia posizionata sopra un tappeto silicopat.

2 - Passare la spatola con pressione sopra i fori.

3 - Sollevare il vassoio e ripetere l'operazione.



1 - Pour and spread the mixture in the tray positioned on a silicopat mat.

2 - Use the spatula, pressing it over the holes.

3 - Lift the saucepan and repeat the steps.

Dischi sottotorta - Under cake round plates

Set di 8 dischi in plastica (PST). Spessore 3mm.
8 plastic plates set (PST). Thickness 3mm.

Cod. **SETDISK**

Ø20 - Ø22 - Ø24 - Ø26 - Ø28 - Ø30 - Ø32 - Ø34 cm

È possibile acquistare i sottotorta separatamente.
It is possible to purchase the under cake separately.

cod. DISCO20	Ø20 cm
cod. DISCO22	Ø22 cm
cod. DISCO24	Ø24 cm
cod. DISCO26	Ø26 cm
cod. DISCO28	Ø28 cm
cod. DISCO30	Ø30 cm
cod. DISCO32	Ø32 cm
cod. DISCO34	Ø34 cm



Tagliere in polietilene - Polyethylene trencher

Cod. **TAG4**
40x30 h3cm

Cod. **TAG5**
50x30 h3cm

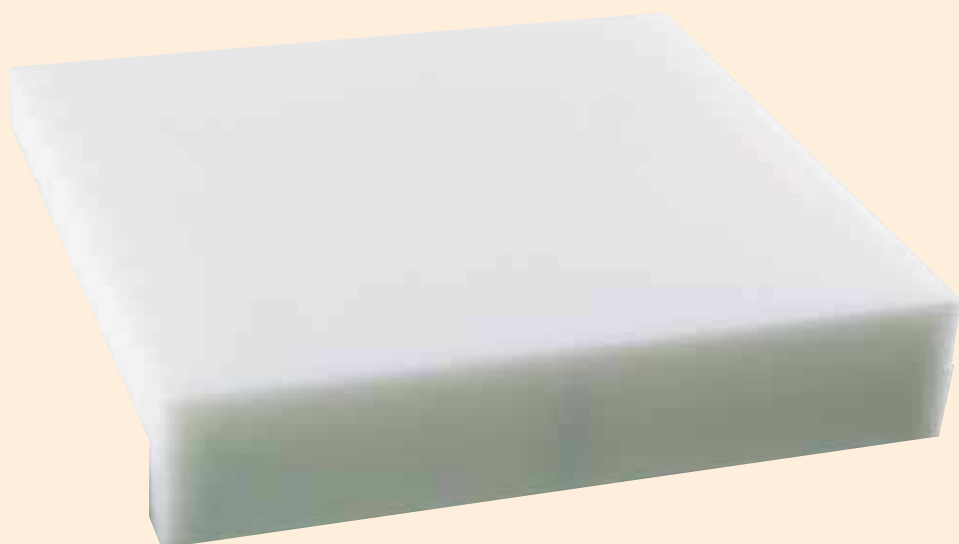

Lira per pan di spagna - Sponge cake slicer

Lira per pan di spagna 3 lame altezza variabile: da 10 a 90 mm.
Sponge cake slicer. In 3 different heights: from 10 until 90 mm.

Cod. **CS3**
460mm

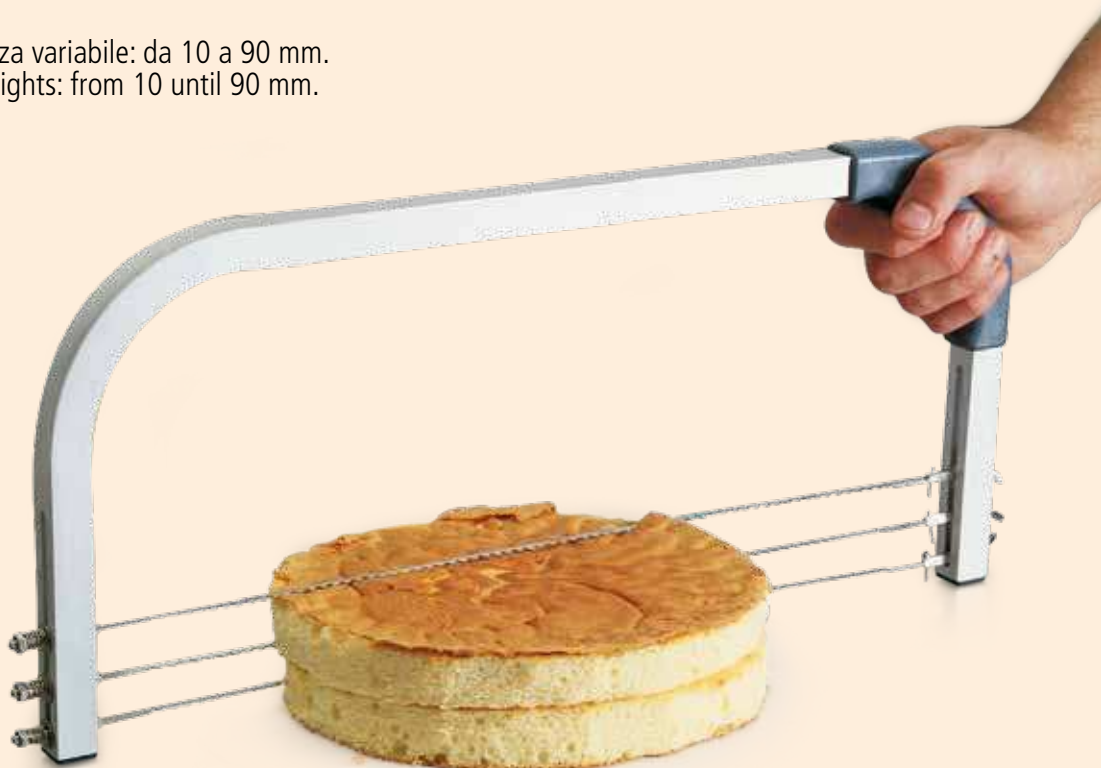

Griglie trasparenti - Transparent grills

Per il taglio del biscuit in perfette strisce da 2-3-4-6 cm.
To cut biscuit obtaining regular stripes: 2-3-4-6 cm.

Cod. **GD2/4**

Griglia speciale per tagli da 2 e 4 cm.
Special grill to cut 2 and 4 cm.

Cod. **GD3/6**

Griglia speciale per tagli da 3 e 6 cm.
Special grill to cut 3 and 6 cm.



Righe trasparenti in plastica - Plastic transparent rulers

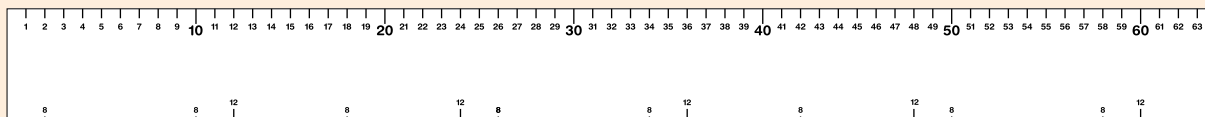

Cod. **RIGA64**

5 Divisioni da 12 cm e 7 divisioni da 8 cm.
5 Divisions for 12 cm and 7 divisions for 8 cm.

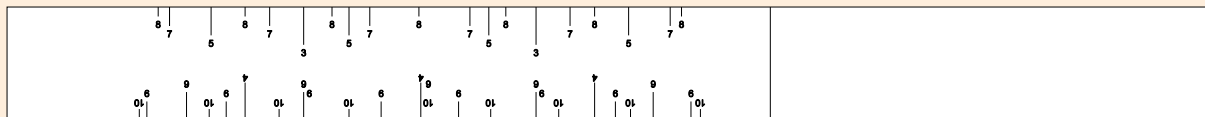
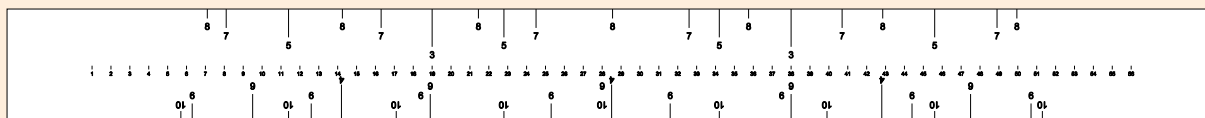

Cod. **RIGAKIT**

Composta da 2 righe adatte per teglie 60X40 cm.
Possibilità di dividere il prodotto in 3-4-5-6-7-8-9-10 parti.
Composed of 2 rulers for 60x40 cm trays.
It is possible to divide the cake in 3-4-5-6-7-8-9-10 shares.

Portaordini settimanale - Kitchen tab grabber

Utile per raggruppare in modo ordinato i vostri ordini.
You can have all your orders in the right place.
Available in different languages.

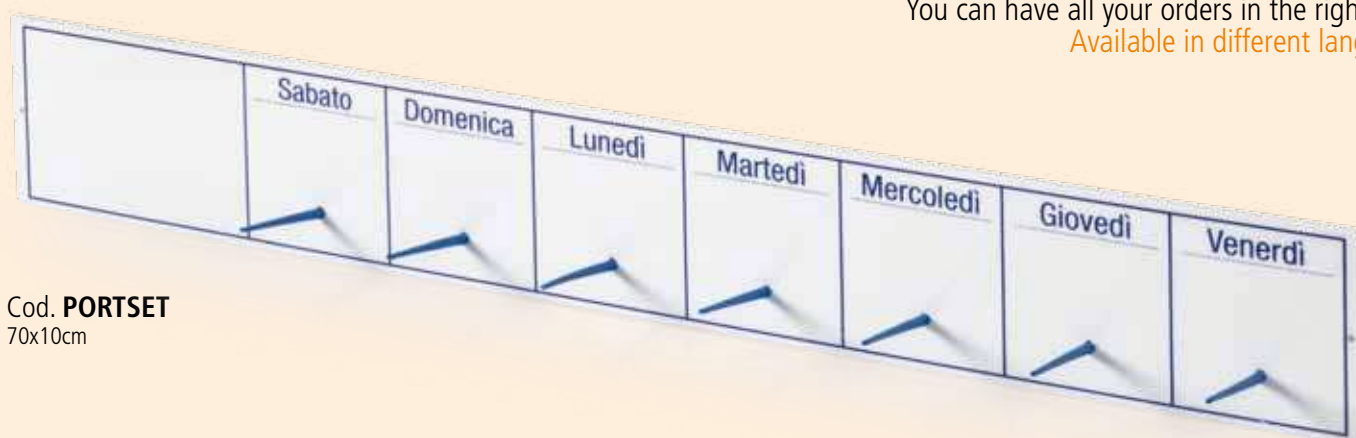

Cod. **PORTSET**

70x10cm

PROFESSIONAL FUNNEL

Cod. **50C0001**

Colino professionale completo.
Complete and professional funnel.



Realizzato in acciaio inox con manico in plastica. Ideale per colare il prodotto negli appositi stampi. Pratico e maneggevole grazie alla doppia impugnatura dal design moderno. Fornito con tre bocchette di: Ø 2mm Ø 4mm Ø 5mm + piedistallo in metallo.

Made of stainless steel with plastic handle. Suitable for pouring the product into the appropriate moulds. Its double handled and, thanks its modern design, the piston funnel is more practical and easy-to-use thanks to the modern design and the double handle. Supplied with three nozzles: Ø 2mm Ø 4mm and 5mm, plus a metal support.



Cod. **50CORIC0**

Bocchetta - Nozzle
Ø 5 mm

Cod. **50CORIC3**

Manico plastica
Plastic handle

Cod. **50CORIC6**

Supporto inox
Metal support

Cod. **50CORIC1**

Bocchetta - Nozzle
Ø 4 mm

Cod. **50CORIC4**

Asta dosatrice
Steel pole

Cod. **50CORIC7**

Mandrino per bocchetta
Nozzle adapter

Cod. **50CORIC2**

Bocchetta - Nozzle
Ø 2 mm

Cod. **50CORIC5**

Imbuto
Funnel

Teglie con coperchi - Trays with lids

Teglie e coperchi in materiale plastico antiurto.
Pans and covers made of strong plastic material.

60x40cm

Coperchio + Vassoio
Lid + Tray

Cod. **VC60X404**

Misure - Size 595x395 mm
h 42 mm

Cod. **VC60X40**

Misure - Size 595x395 mm
h 62 mm

Cod. **VC60X408**

Misure - Size 595x395 mm
h 82 mm

30x40cm

Coperchio + Vassoio
Lid + Tray

Cod. **VC30X40**

Misure - Size 300x400 mm
h 62 mm



Coperchi - Lids

Coperchio speciale per la protezione dei prodotti in frigorifero, congelatore ed abbattitore.
Evita lo sviluppo di odori, la formazione di brina, la disidratazione e la condensa.

[Su richiesta coperchio con altezza personalizzata.](#)

Special lid to protect the products in refrigerators, freezers and blast chillers.
They avoid the risk of bad smell, frost, dehydration condensation.

[Personalized height on request.](#)

60x40cm

Coperchi - Lid

Cod. **COVER 3H4**

Misure - Size 590x390 mm
h 40 mm

Cod. **COVER 3**

Misure - Size 590x390 mm
h 60 mm

Cod. **COVER 8**

Misure - Size 590x390 mm
h 80 mm

30x40cm

Coperchi - Lid

Cod. **COVER 4**

Misure - Size 300x400 mm
h 60 mm

Teglie - Trays

Teglie in materiale plastico antiurto.
Tray made of strong plastic material.

60x40cm

Vassoio - Tray

Cod. **VASSOIOCMO**

Misure - Size 598x397 mm
h 20 mm

Cod. **VASSOIOCFMI**

Misure - Size 590x397 mm
h 25 mm

30x40cm

Vassoio - Tray

Cod. **VASSOIOBMI**

Misure - Size 297x396 mm
h 20 mm

altre misure

Vassoio - Tray

Cod. **VASSOIOAMO**

Misure - Size 176x397 mm
h 19 mm

Cod. **VASSOIOAMI**

Misure - Size 201x396 mm
h 18 mm

Cod. **VASSOIOBMO**

Misure - Size 259x396 mm
h 20 mm



PROFESSIONAL SPATULAS

Spatole rigide in ABS
Resistenti a temperature fino 100°C.
ABS rigid spatulas.
Heat resistant up to 100°C.

cod. **50SA150B** 150mm
cod. **50SA250B** 250mm



Spatole morbide in TPE
Resistenti a temperature fino 100°C.
TPE soft spatulas.
Heat resistant up to 100°C.

cod. **50SG250B** 250mm
cod. **50SG300B** 300mm
cod. **50SG350B** 350mm

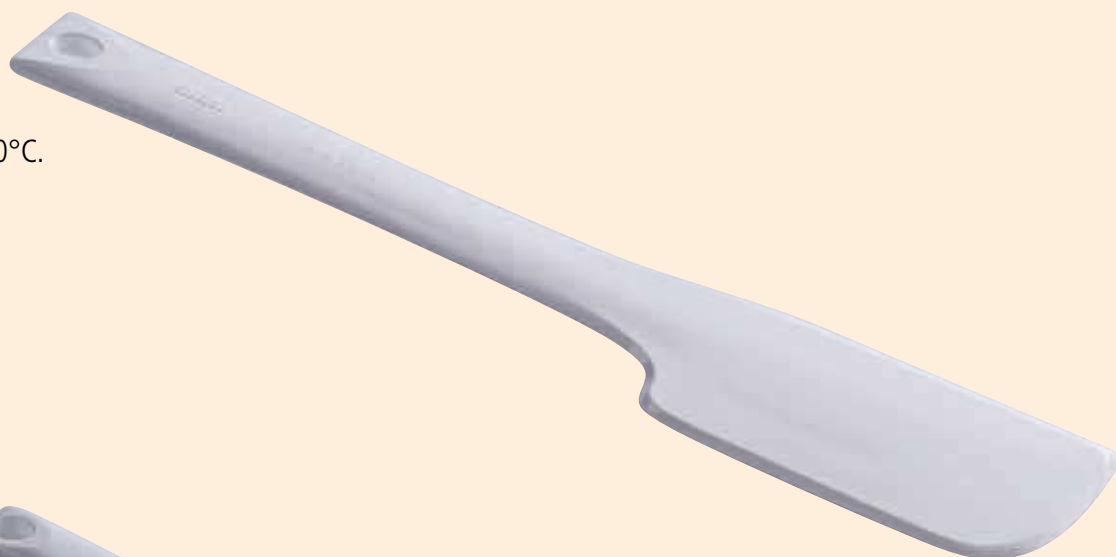

Spatole rigide in ABS
Resistenti a temperature fino 100°C.
ABS rigid spatulas.
Heat resistant up to 100°C.

cod. **50SL300B** 300mm
cod. **50SL370B** 370mm

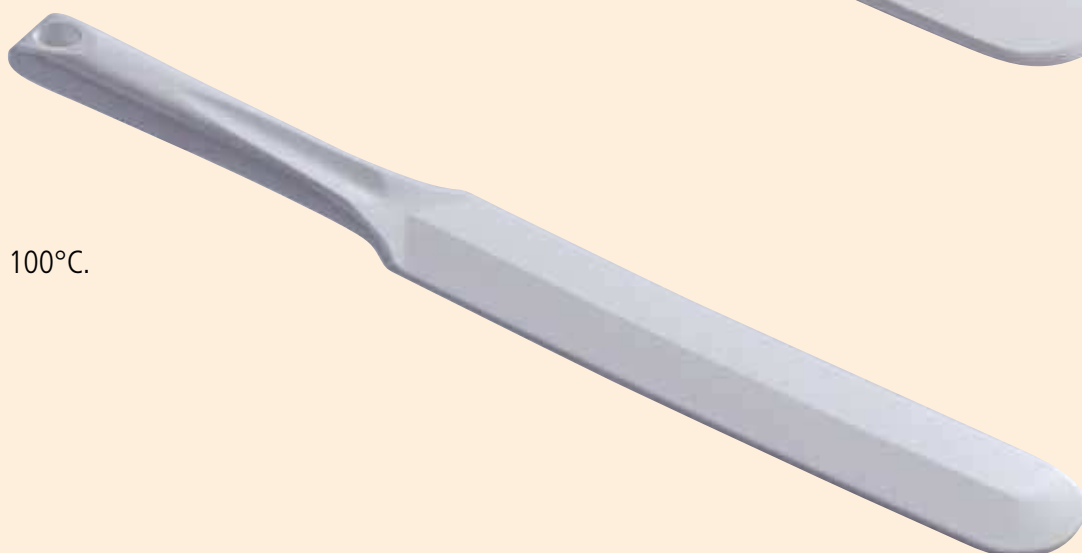

Spatole rigide in ABS
Resistenti a temperature fino 100°C.
ABS rigid spatulas.
Heat resistant up to 100°C.

cod. **50SP300B** 300mm
cod. **50SP350B** 350mm
cod. **50SP400B** 400mm

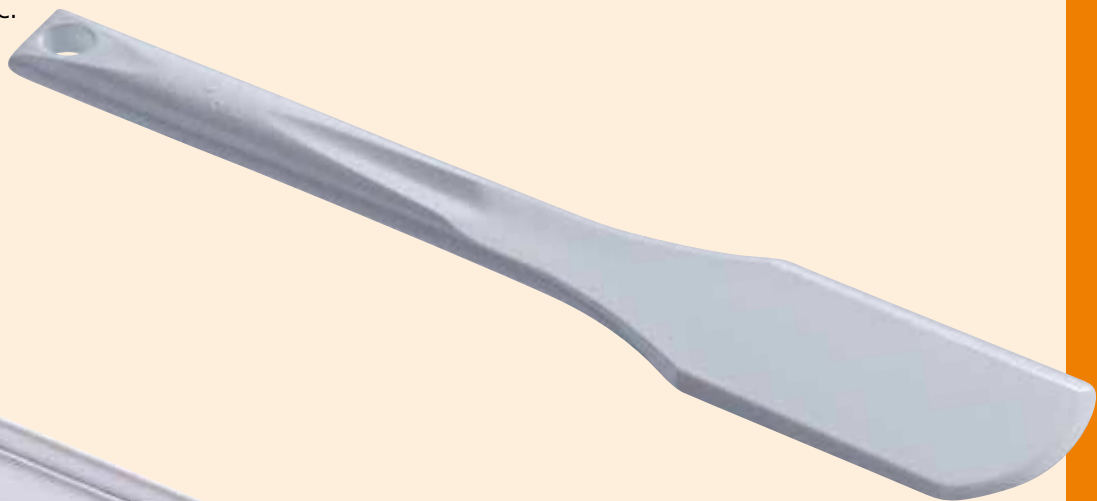

Spatole rigide in ABS
Resistenti a temperature fino 140°C.
ABS rigid spatulas.
Heat resistant up to 140°C.

cod. **SCM30** 300mm
cod. **SCM35** 350mm
cod. **SCM40** 400mm



new
Spatole in gomma
con manico in polipropilene.
Rubber spatulas
with polypropylene handle.

cod. **50GO300** 300mm
cod. **50GO350** 350mm
cod. **50GO400** 400mm

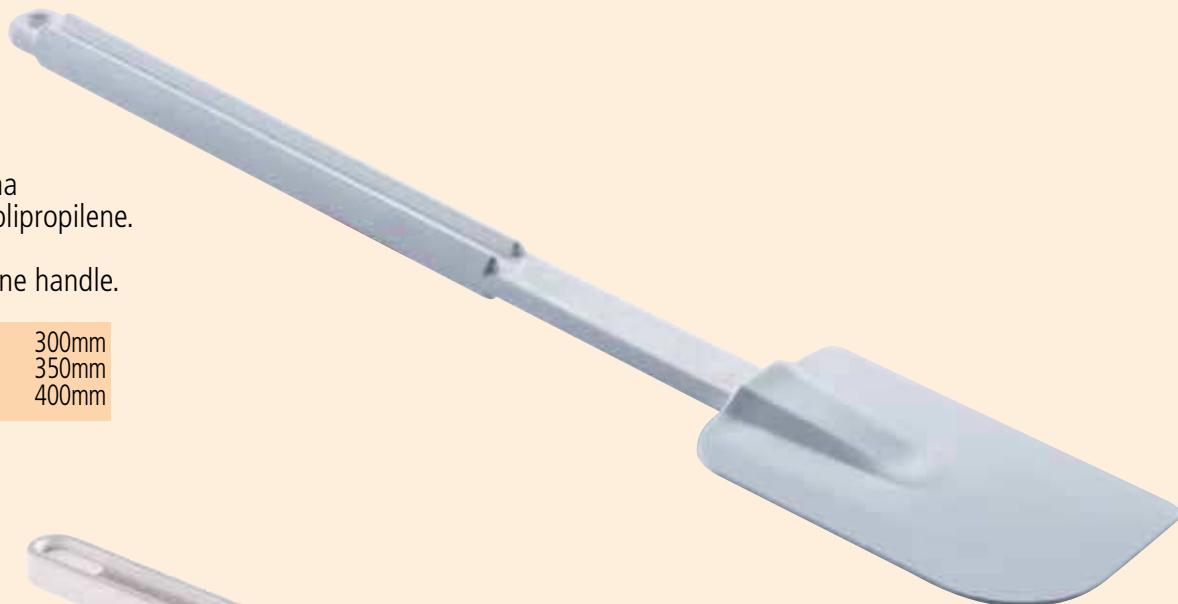

Spatole in gomma con manico in plastica.
Resistenti a temperature fino 110°C.
Rubber spatulas with plastic handle.
Heat resistant up to 110°C.

cod. **MEL250** 250mm
cod. **MEL350** 350mm
cod. **MEL450** 450mm

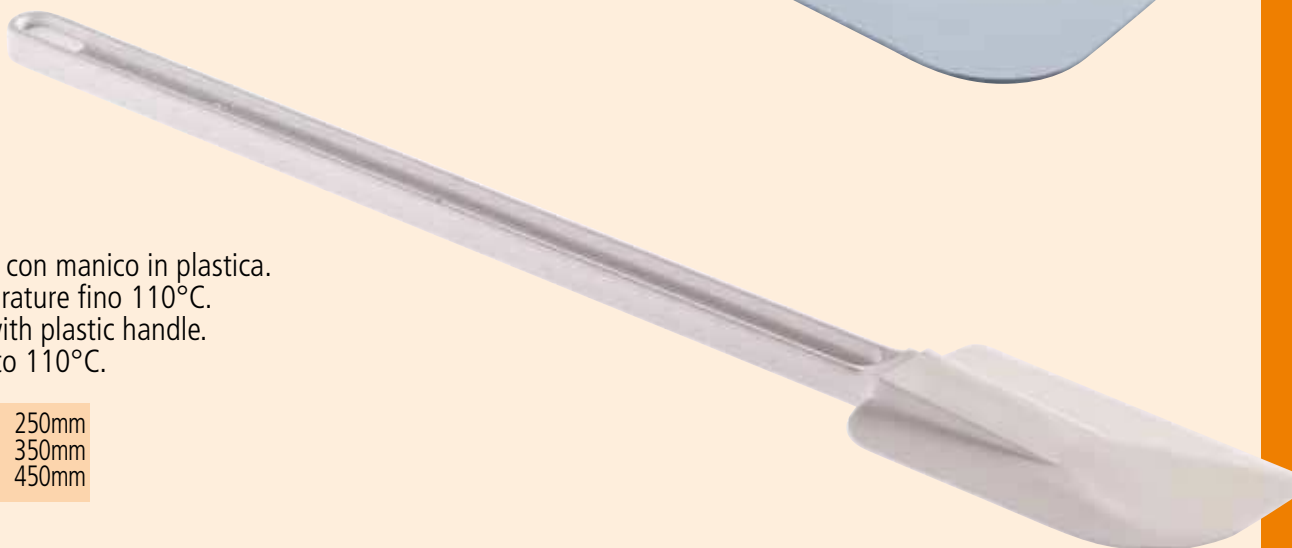

Spatole in gomma a cucchiaio con manico in plastica.
Resistenti a temperature fino 110°C.
Spoon shaped rubber spatulas with plastic handle.
Heat resistant up to 110°C.

cod. **MSP250** 250mm
cod. **MSP350** 350mm



Spatole in Polyglass.
Resistente fino a 220°C.
Polyglass spatulas.
Heat resistant up to 220°C.

cod. **MEX250** 250mm
cod. **MEX300** 300mm
cod. **MEX400** 400mm
cod. **MEX500** 500mm

Spatole angolari in plastica rinforzata.
Resistenti a temperature fino 130°C.
Angular spatulas.
Heat resistant up to 130°C.

cod. **SPANG 29** 290mm
cod. **SPANG 39** 390mm

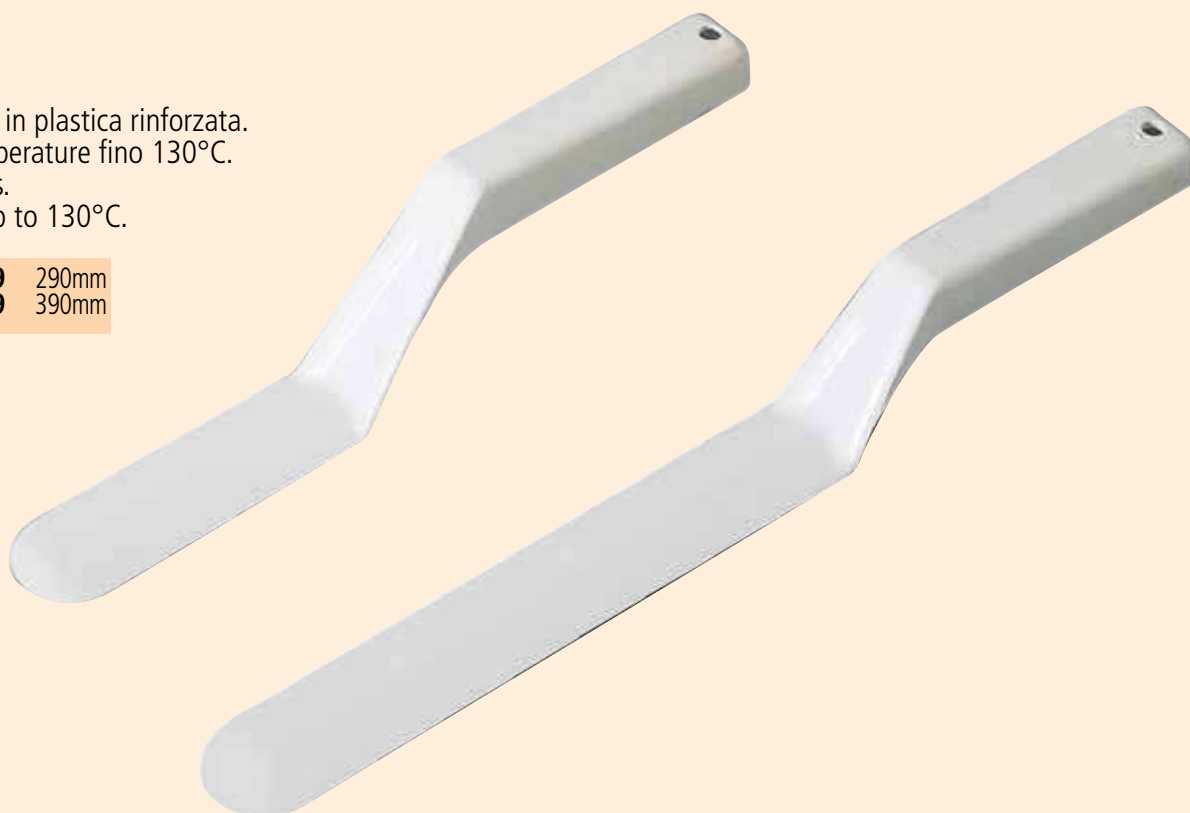

Spatola inox con manico in plastica.
Inox cake spatula with plastic handle.

cod. SPA16	150mm
cod. SPA21	205mm
cod. SPA26	250mm
cod. SPA31	300mm
cod. SPA36	345mm



Spatola angolare con manico in plastica, lama inox flessibile.
Misura manico 12 cm
Angular cake spatula with plastic handle, inox flexible blade.
Handle size 12 cm.

cod. SPANG 16	155mm
cod. SPANG 21	195mm
cod. SPANG 26	245mm
cod. SPANG 31	295mm



Pala per dolci
Cake shovel

cod. TS1	Ø280 mm
-----------------	---------



DOUGH AND BREAD EQUIPMENT



Cod. **STPTA 6**
Ø8cm



Cod. **STPTA 7**
Ø8cm



Cod. **STPTA 8**
Ø8cm



Cod. **STPTA 9**
Ø8cm



Cod. **STPTA 10**
Ø8cm



Cod. **STPTA 11**
Ø8cm



Cod. **STPTA 12**
Ø8cm



Cod. **STPTA 13**
Ø8cm



Cod. **STPTA 14**
Ø8cm



Cod. **STPZ**
Ø8cm



Cod. **STPK**
Marcatore girevole per pane kaiser
Kaiser bread marker



Cod. **55TP6080**

Teli pane in nylon trasparente
Transparent nylon bread sheets
Misura - Size: 60x80 cm
pack 50 pcs
70 micron



Cod. **STPTA 1**
14x10cm

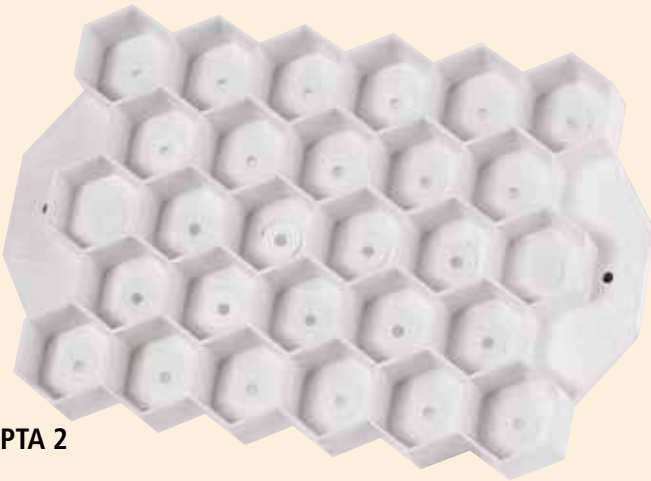

Cod. **STPTA 2**
14x11cm

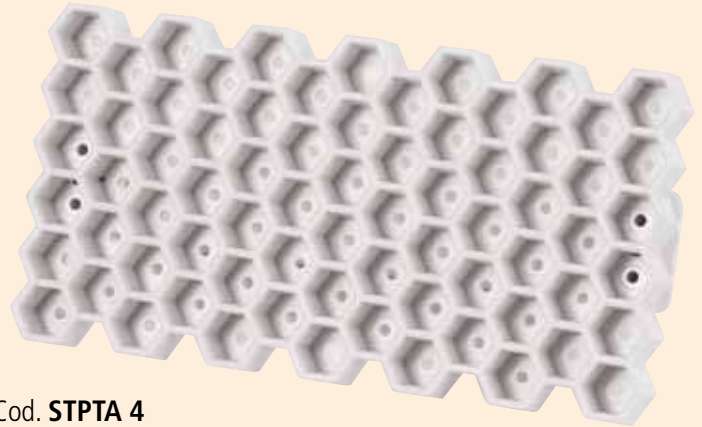

Cod. **STPTA 4**
16,5x8,5cm



Cod. **STPTA 5**
Ø12,5cm



Cod. **STPTA 3**
Ø12,5cm

Cestini in polipropilene per l'impasto. Lavabili in lavastoviglie.
Bread baskets made of polypropylene. Dishwasher safe.



cod. **BASKET 205** Ø25cm 1500gr
cod. **BASKET 206** Ø21,5cm 1000gr
cod. **BASKET 207** Ø18cm 500gr
cod. **BASKET 208** Ø13cm 250gr

cod. **BASKET 105** 40x14cm 1500gr
cod. **BASKET 106** 35x13cm 1000gr
cod. **BASKET 107** 27x12cm 500gr

cod. **BASKET 102** 29x18cm 1000gr
cod. **BASKET 103** 22x14cm 500gr
cod. **BASKET 108** 24x14cm 750gr

Rulli di legno
Wooden rolling pins

cod. **RL 1** Ø70 x500 mm
 cod. **RL 2** Ø80 x500 mm
 cod. **RL 3** Ø70 x600 mm
 cod. **RL 4** Ø80 x600 mm



Rulli di legno girevoli
Revolving wooden rolling pins

cod. **RLS 30** Ø80 x300 mm
 cod. **RLS 35** Ø80 x350 mm
 cod. **RLS 40** Ø80 x400 mm
 cod. **RLS 45** Ø80 x450 mm
 cod. **RLS 50** Ø80 x500 mm
 cod. **RLS 60** Ø80 x600 mm



Rulli in polietilene
Polyethylene rolling pins

cod. **RLS 50 PE** Ø70 x300 mm
 cod. **RLS 60 PE** Ø70 x400 mm
 cod. **RLS 70 PE** Ø70 x500 mm



Rulli in polietilene ideali per pasta zucchero
Polyethylene rolling pins for sugar paste

cod. **40-W022** Ø45 x500 mm
 cod. **40-W154** Ø45 x350 mm
 cod. **40-W021** Ø25 x230 mm



Rullo per grissini in polietilene.
Bread stick rolling pin made of polyethylene.

cod. **SCA 10** Ø100 x195 mm Taglio - Cut: 10 mm
 cod. **SCA 15** Ø100 x195 mm Taglio - Cut: 15 mm



Rulli tagliapasta in polietilene,
per ottenere strisce di marzapane, pastafrolla.
Polyethylene rolling cutters
to make marzipan or pastry stripes.

cod. **RLT 5** 195 mm Taglio - Cut: 5 mm
 cod. **RLT 10** 195 mm Taglio - Cut: 10 mm
 cod. **RLT 15** 195 mm Taglio - Cut: 15 mm





Rullo inox forapasta
St. Steel roller docker

cod. **RFP12INOX** 120 mm

Rullo inox per losanghe - 7mm
Lattice cutting roller - 7mm

cod. **RPL12INOX** 120 mm

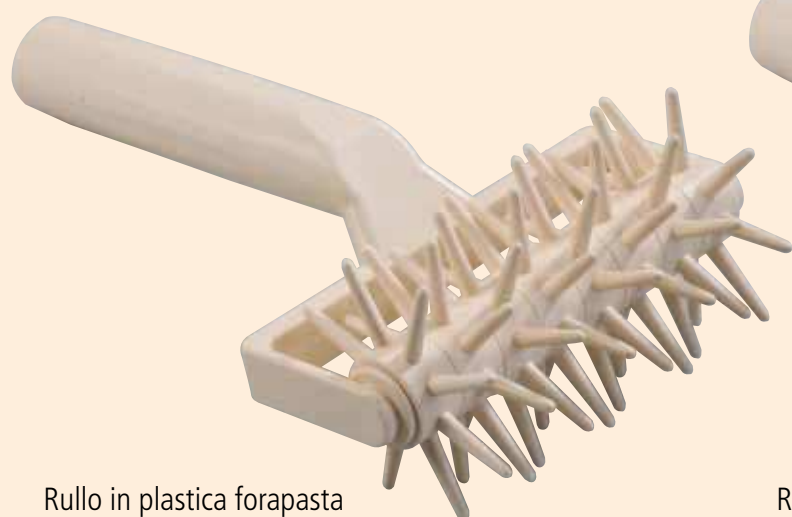

Rullo in plastica forapasta
Plastic roller dockers

cod. **RFP12** 120 mm
cod. **RFP6** 60 mm



Rullo in plastica per losanghe
Plastic lattice cutting rollers

cod. **RPL12** 120 mm
cod. **RPL6** 60 mm



Rullo in plastica per strudel
Plastic cutting wheel

cod. **RPS6** 60 mm

Taglia croissant triangolari acciaio inox e manico ergonomico in plastica.
Triangular croissant cutters made of stainless steel, with ergonomic plastic handle.

Cod. **RDC180X200**
180x200mm



Cod. **RTC180X200**
180x200mm

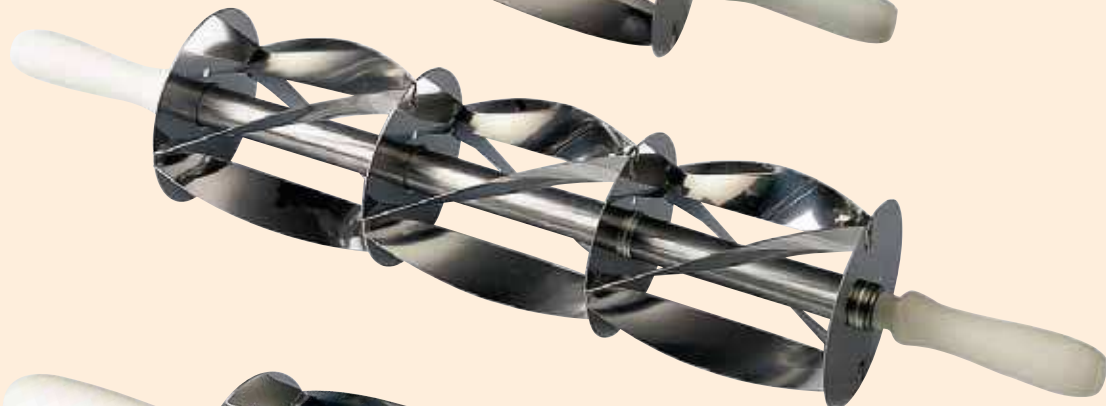

Cod. **RSC110X150**
110x150mm

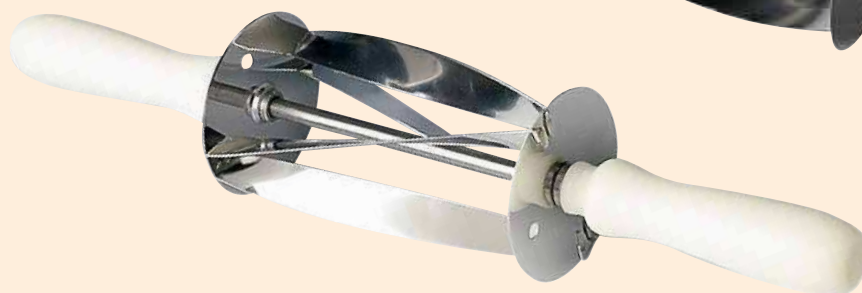

Cod. **RSC180X140**
180x140mm

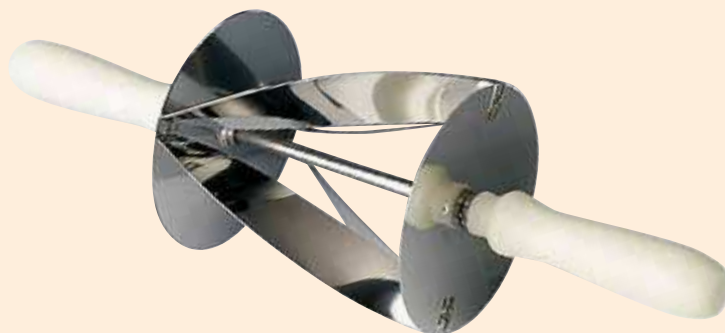

Cod. **RSC180X200**
180x200mm



Cod. **RSC97X210**
97x210mm



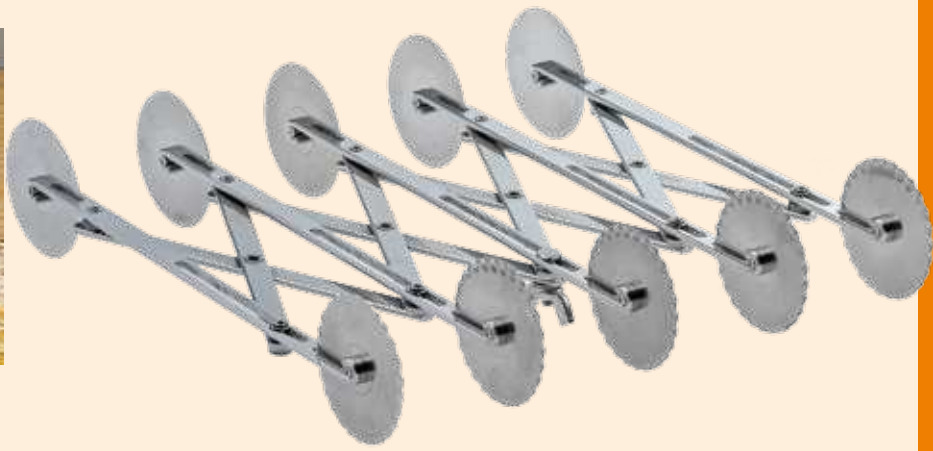

Tagliapasta inox estendibile
St. Steel extendable multi-cutters

cod. ROTAPINOX 5 P	Liscia / Plain	Tagli - cuts: 5
cod. ROTAPINOX 5 O	Ondulata / Wavy	Tagli - cuts: 5
cod. ROTINOX 5 P/O	Liscia e Ondulata / Plain and Wavy	Tagli - cuts: 5
cod. ROTAPINOX 7 P	Liscia / Plain	Tagli - cuts: 7
cod. ROTAPINOX 7 O	Ondulata / Wavy	Tagli - cuts: 7
cod. ROTINOX 7 P/O	Liscia e Ondulata / Plain and Wavy	Tagli - cuts: 7



Tagliapizza
Pizza cutters

cod. PC001	95x250 mm
cod. PC002	95x305 mm
cod. PC003	95x350 mm
cod. PC004	95x400 mm

Tagliapizza
Pizza cutters

cod. PC55	Ø55mm
cod. PC65	Ø65mm
cod. PC100	Ø100mm
cod. PC120	Ø120mm



BREAD CUTTERS



Cod. CUTTER1



Cod. CUTTER4



Cod. CUTTER6



Cod. CUTTER7



Cod. CUTTER8



Cod. CUTTER15



Cod. CUTTER9



Cod. CUTTER10



Cod. CUTTER11SET



Cod. CUTTER12



Cod. CUTTER13
kit 2 pcs



Cod. CUTTER14



Cod. CUTTER5



Cod. CUTTER5/A

PRICE CARDS



Cod. **SEG001**
70x40mm
25 pcs



Cod. **SEG002**
60x80mm
25 pcs



Cod. **SEG003**
45x65mm
30 pcs



Cod. **SEG004**
35x40mm
30 pcs



Cod. **SEG005**
55x80mm
50 pcs



Cod. **SEG006**
60x80mm
25 pcs



Cod. **SEG008**
60x90mm
25 pcs



Cod. **SEG015**
60x50mm
50 pcs



Cod. **SEG021**
60x95mm
25 pcs



Cod. **SEG022**
70x87mm
25 pcs



Cod. **SEG023**
75x52mm
15 pcs



Cod. **SEG024**
55x92mm
25 pcs



Cod. **SEG025**
62x86mm
25 pcs



Cod. **SEG026**
50x85mm
25 pcs



Cod. **SEG027**
65x62mm
15 pcs

STAINLESS STEEL CUTTERS

Taglia pasta singoli, con manico.
Singles cutter, with handle.



Cod. **CUT1FM12**
Ø 120 x h20 mm



Cod. **CUT1FM14**
Ø 140 x h20 mm



Cod. **CUT1LM12**
Ø 120 x h20 mm



Cod. **CUT1LM14**
Ø 140 x h20 mm



Cod. **CUT12LM1**
Ø 89 x h20 mm



Cod. **CUT15LM1**
Ø 100 x h20 mm



Cod. **CUT23LM1**
Ø91 x h20 mm



Cod. **CUT27LM1**
Ø79 x h20 mm



Cod. **CUT50LM1**
Ø100 x h20 mm



Cod. **CUT60LM1**
Ø100 x h20 mm



Cod. **CUT70LM1**
Ø100 x h20 mm

**Set taglia pasta con manico.
Cutters with handle set.**



Cod. **CUT17LM2**

60x45 x h20 mm

73x55 x h20 mm



Cod. **CUT19LM3**

Ø65 x h20 mm

Ø50 x h20 mm

Ø80 x h20 mm



Cod. **CUT27LM3**

Ø55 x h20 mm

Ø65 x h20 mm

Ø80 x h20 mm



Cod. **CUT50LM2**

Ø60 x h20 mm

Ø90 x h20 mm



Cod. **CUT60LM2**

Ø65 x h20 mm

Ø80 x h20 mm



Cod. **CUT70LM2**

Ø65 x h20 mm

Ø80 x h20 mm



Cod. **CUT80LM3**

Ø45 x h20 mm

Ø60 x h20 mm

Ø85 x h20 mm

Set tagliapasta in scatola
Box cutters set

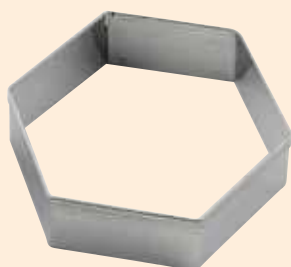

Cod. **CUT3L7**

7 pcs
 75 - 67 - 63 - 57 - 52 - 47 - 42 mm



Cod. **CUT4L7**

7 pcs
 75 - 70 - 65 - 60 - 55 - 50 - 45 mm

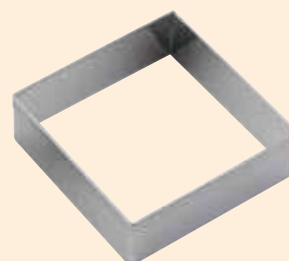

Cod. **CUT5L7**

7 pcs
 65 - 57 - 50 - 45 - 40 - 35 - 27 mm

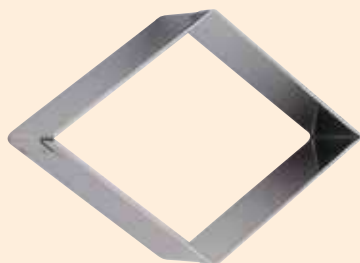

Cod. **CUT6L7**

7 pcs
 90x60 - 80x50 - 70x45 - 60x40
 50x30 - 40x25 - 30x20 mm



Cod. **CUT8L7**

7 pcs
 90x60 - 80x50 - 70x45 - 65x40
 55x33 - 45x25 - 35x20 mm



Cod. **CUT9L7**

7 pcs
 90x60 - 85x55 - 75x50 - 65x43
 55x40 - 50x32 - 40x25 mm

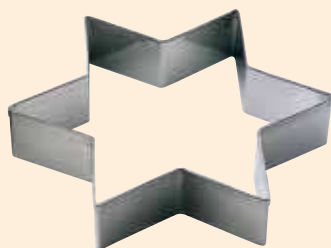

Cod. **CUT10L9**

9 pcs
 37 - 51 - 66 - 82 - 96 - 110
 125 - 137 - 150 mm



Cod. **CUT12L7**

7 pcs
 90 - 80 - 65 - 53 - 42 - 55 - 30 mm



Cod. **CUT14L7**

7 pcs
 85 - 80 - 75 - 70 - 65 - 55 - 45 mm



Cod. **CUT15L7**

7 pcs
86x45 - 76x38 - 68x33 - 61x30
55x25 - 49x21 - 42x17 mm

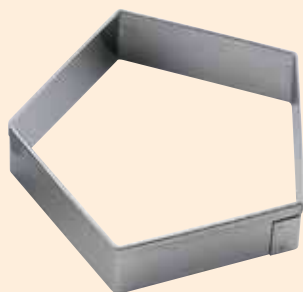

Cod. **CUT16L7**

7 pcs
80 - 75 - 67 - 60 - 50 - 40 - 33 mm



Cod. **CUT17L7**

7 pcs
75x55 - 70x50 - 50x45 - 55x45
50x37 - 45x33 - 35x27 mm



Cod. **CUT18L7**

7 pcs
90x65 - 80x60 - 70x50 - 55x40
45x30 - 33x23 - 25x18 mm



Cod. **CUT19L7**

7 pcs
95 - 85 - 75 - 70 - 60 - 50 - 45 mm



Cod. **CUT20L7**

7 pcs
90 - 75 - 70 - 55 - 45 - 40 - 25 mm



Cod. **CUT21L7**

7 pcs
90x65 - 80x55 - 70x50 - 55x40
45x33 - 35x25 - 27x20 mm

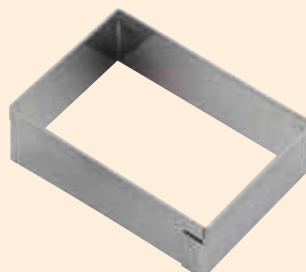

Cod. **CUT22L7**

7 pcs
65x50 - 60x45 - 55x40 - 50x35
47x32 - 43x28 - 37x25 mm



Cod. **CUT23L7**

7 pcs
95 - 85 - 75 - 60 - 45 - 35 - 30 mm



Cod. **CUT24L7**

7 pcs
90x50 - 80x46 - 75x43 - 70x40
60x35 - 55x33 - 50x30 mm



Cod. **CUT25L7**

7 pcs
90x50 - 80x46 - 75x43 - 70x40
60x35 - 55x33 - 50x30 mm



Cod. **CUT26L7**

7 pcs
90 - 80 - 70 - 55 - 40 - 35 - 30 mm



Cod. **CUT27L7**

7 pcs
90 - 80 - 70 - 55 - 40 - 35 - 30 mm



Cod. **CUT28L7**

7 pcs
100x50 - 90x45 - 85x43 - 75x40
70x35 - 60x30 - 55x25 mm



Cod. **CUT29L7**

7 pcs
80x50 - 75x45 - 68x40 - 62x37
55x33 - 50x29 - 44x25 mm



Cod. **CUT30L7**

7 pcs
95x60 - 85x50 - 70x45 - 55x38
45x30 - 35x25 - 25x18 mm

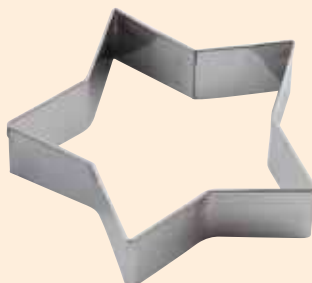

Cod. **CUT31L7**

7 pcs
90 - 80 - 70 - 60 - 50 - 40 - 30 mm



Cod. **CUT1L7**

7 pcs
30 - 40 - 50 - 60 - 70 - 80 - 90 mm



Cod. **CUT1L9**

9 pcs
30 - 40 - 50 - 60 - 70 - 80 - 90
100 - 110 mm



Cod. **CUT1L12**

12 pcs
30 - 40 - 50 - 60 - 70 - 80 - 90
100 - 110 - 120 - 130 - 140 mm



Cod. **CUT1L16**

16 pcs
20 - 30 - 40 - 50 - 60 - 70 - 75 - 80 - 85 - 90
95 - 100 - 110 - 120 - 125 - 140 mm



Cod. **CUT2L7**

7 pcs
85x70 - 75x65 - 65x55 - 55x45
45x35 - 35x25 - 23x18 mm



Cod. **CUT2L9**

9 pcs
27x34 - 33x46 - 42x57 - 51x68 - 62x78
71x87 - 82x97 - 92x107 - 102x117 mm



Cod. **CUT2L12**

12 pcs
40x30 - 50x40 - 60x50 - 70x60 - 80x70 - 90x80
100x90 - 110x100 - 120x110 - 130x120
140x120 - 150x130 mm

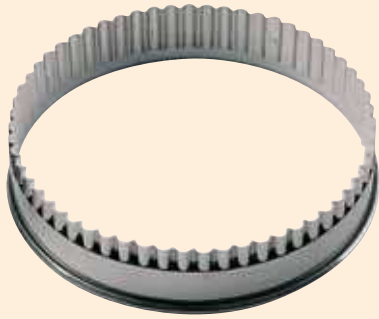

Cod. **CUT1F9**

9 pcs
30 - 40 - 50 - 60 - 70 - 80
90 - 100 - 110 mm

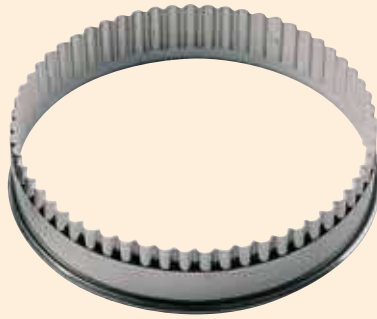

Cod. **CUT1F12**

12 pcs
30 - 40 - 50 - 60 - 70 - 80
90 - 100 - 110 - 120 - 130 - 140 mm



Cod. **CUT7F9**

9 pcs
60 - 70 - 80 - 90 - 100 - 110 - 120 - 130 - 140 mm

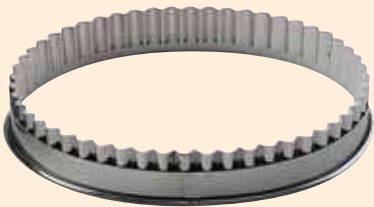

Cod. **CUT2F9**

9 pcs
27x34 - 33x46 - 42x57 - 51x68 - 62x78
71x87 - 82x97 - 92x107 - 102x117 mm



Cod. **CUT2F12**

12 pcs
40x30 - 50x40 - 60x50 - 70x60 - 80x70 - 90x80 - 100x90
110x100 - 120x110 - 130x120 - 140x120 - 150x130 mm

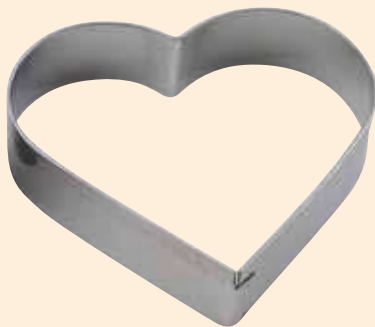

Cod. **CUT7L7**

7 pcs
35 - 40 - 45 - 55 - 65 - 75 - 85 mm

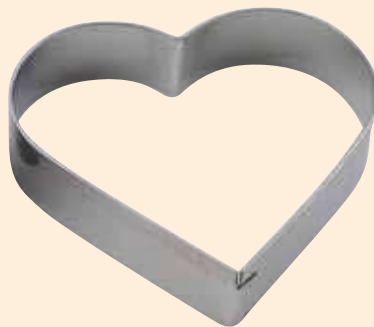

Cod. **CUT7L9**

9 pcs
36 - 43 - 52 - 60 - 70 - 80 - 90 - 100 - 110 mm

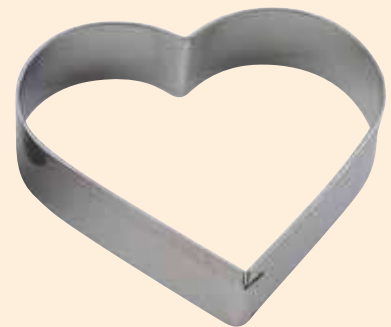

Cod. **CUT7L12**

12 pcs
36 - 43 - 52 - 60 - 70 - 80 - 90 - 100
110 - 120 - 130 - 140 mm

Set tagliapasta inox per praline - St. Steel praline cutters set



Cod. **PRA9**

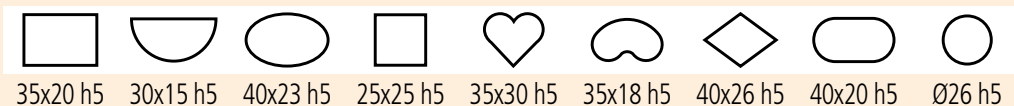

PLASTIC CUTTERS



Cod. **GTB01**
Cuori - Hearts

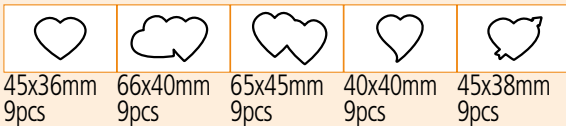

Cod. **GTB02**
Halloween



Cod. **GTB03**
Natale / Christmas

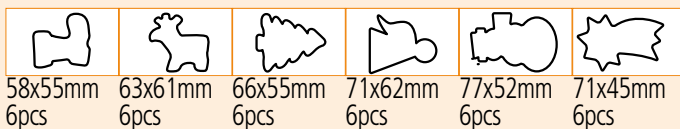

Cod. **GTB04**
Pasqua/ Easter

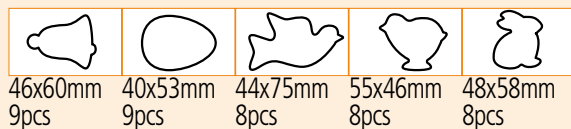

Cod. **GTB05**
Fiori Foglie / Flowers Leaves

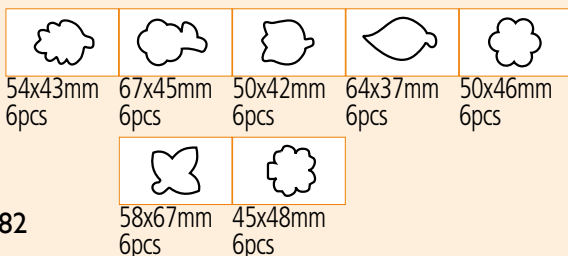

Cod. **GTB06**
Anim. domestici / Animals

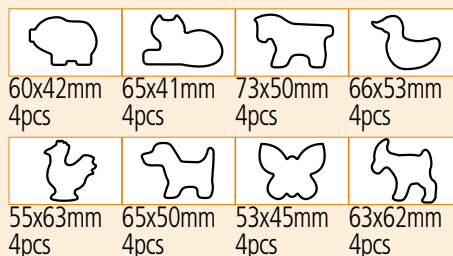



Cod. **GTB07**

Animali selvaggi / Wild animals



54x65mm 4pcs
61x56mm 4pcs
57x61mm 4pcs
90x40mm 4pcs



70x40mm 4pcs
60x66mm 4pcs
70x48mm 4pcs
68x50mm 4pcs



Cod. **GTB08**

Frutta / Fruit



64x47mm 6pcs
69x37mm 6pcs
68x42mm 6pcs
63x57mm 6pcs



64x46mm 6pcs
68x39mm 6pcs



Cod. **GTB09**

Animali marini / Marine animals



85x47mm 6pcs
54x105mm 6pcs
90x60mm 6pcs
72x73mm 6pcs
Ø80mm 5pcs



Cod. **GTB10**

Trasporti / Transport



55x65mm 4pcs
78x51mm 4pcs
98x63mm 4pcs
80x44mm 4pcs



70x67mm 4pcs
85x61mm 4pcs
72x48mm 4pcs
73x42mm 4pcs



Cod. **GTB11**

Carte da gioco / Cards



58x46mm 10pcs
50x46mm 10pcs
50x52mm 10pcs
50x50mm 10pcs



Cod. **GTB12**

Musica / Music

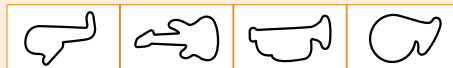

75x56mm 5pcs
91x48mm 5pcs
88x50mm 5pcs
70x47mm 5pcs



65x44mm 5pcs
59x54mm 5pcs
98x52mm 5pcs



Cod. **GTB14**
Osso - Bone



107x52mm
20pcs



Cod. **GTB15**
Tondo festonato - Wavy round



Ø39mm
40pcs



Cod. **GTB16**
Tondo - Round



Ø37mm
40pcs



Cod. **GTB17**
Stella - Star



42x38mm
35pcs



Cod. **GTB18**
Croce Festonata - Wavy Cross



40x40mm
35pcs



Cod. **GTB19**
Cuore - Heart



39x36mm
40pcs





Cod. **GTB20**
Luna - Moon



37x22mm
50pcs



Cod. **GTB21**
Tris



39x37mm
40pcs



Cod. **GTB22**
Uovo - Egg



52x33mm
32pcs



Cod. **GTB23**
Kit Griglia Taglia biscotti carnevale 60x40cm e cutter per occhi.
Carnival biscuit cutter frame kit 60x40 cm and cutter for eyes.



93x37mm 5pcs
93x40mm 5pcs
93x40mm 5pcs
93x42mm 5pcs



SAN MARTINO dolce tipico
SAINT MARTIN cookies cutter traditional cake

Cod. **GTB13**
Biscotti San Martino

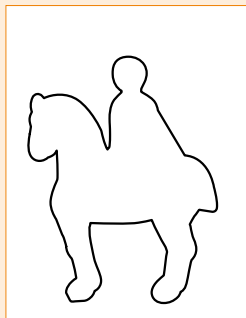

100x77mm



Cod. **SMA320**
Dolce San Martino
320x340 mm

Cod. **SMA180**
Dolce San Martino
180x200 mm

Cod. **SMA260**
Dolce San Martino
260x280 mm

Cod. **SMA110**
Dolce San Martino
110x125 mm



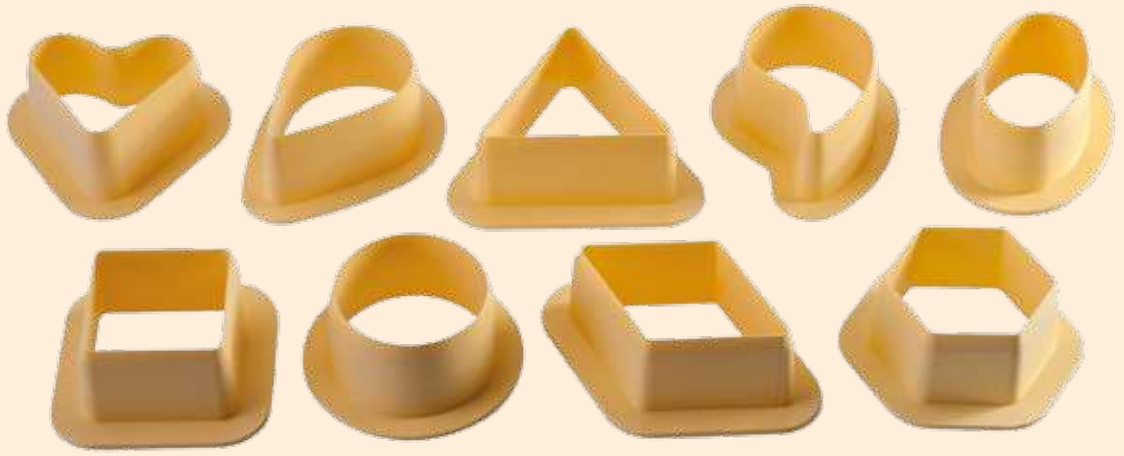

Cod. **TPGSET**
set 9 cutter

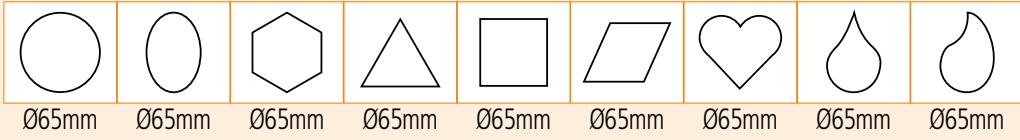

Cod. **TPGSET/2**
set 7 cutter



Cod. **TPMSET**
set 9 cutter

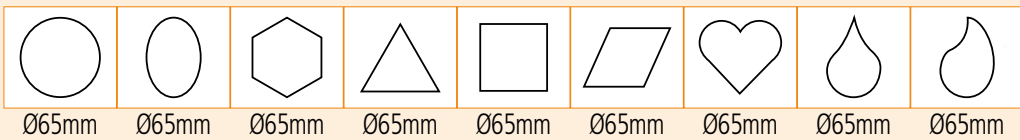

SALES DISPLAY

Espositore in metallo - Metal display

Cod. **ESPOSITORE**

95x55 h210 cm
con 20 ganci inclusi
with 20 hooks included

Crowner incluso.
Crowner included.



Espositore in legno - Wooden display

Cod. **ESPOWMONOUSO**

78,5x52 h195 cm

Crowner non incluso.
Crowner not included.

Cod. **CRWESPOWMONOUSO**



Crowner

Espositore in legno da terra per scatole **green poche**.
Standing wooden display for **green poche** boxes.

Cod. **ESPOWG70GP**

Misura/Size:

49,4x46,5 h150 cm

Crowner non incluso.
Crowner not included.

Cod. **CRWESPOWG70GP**

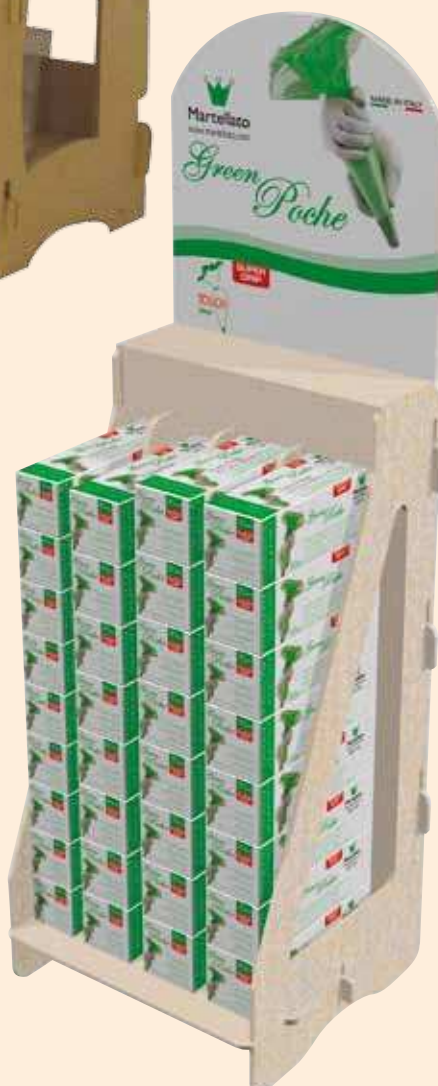

Espositore
Display

AIRBRUSH EQUIPMENT



Cod. **DECOAIR2**
Cap. 7 CC
Ø 0,3mm



Cod. **DECOAIR3**
Cap. 2 CC
Ø 0,2mm



Cod. **DECOAIR4**
Cap. 2 CC
Ø 0,2mm



Cod. **DECOAIR5**
Cap. 20 CC - 40 CC
Ø 0,2mm



Cod. **DECOAIR6**
Cap. 2 CC - 5 CC - 13 CC
Ø 0,3mm



Cod. **DECOMP8**
BAR 2,5



Cod. **DECOMP7**
BAR 4

Cod. **DECOCP01**

Il kit per piccole decorazioni include:

- Penna aerografa a doppia azione, Ø 0,2mm;
- Mini Compressore da 1 BAR;
- Supporto per penna aerografa;
- Trousse nera da viaggio.

The kit for small decorations includes:

- Airbrush double action, Ø 0.2mm;
- Mini compressor 1 BAR;
- Support for airbrush;
- Black travel bag.



Cod. **DECOV01**
Vaschetta per la pulizia dell'aerografo.
Container for airbrush cleaning.



Cod. **DECOF01**
Filtro per aerografo.
Airbrush filter.



Cod. **DECOH01**
Sostegno per aerografo.
Airbrushes holder.



Cod. **MD 2**
Sostegno per aerografo.
Airbrushes holder.

FOOD COLOURING

Martellato propone una linea completa di coloranti alimentari per dolci, in versione spray, in polvere o in gelatina, ideali per impreziosire e dare un tocco di fantasia a dolci, gelati e altri prodotti dolciari.

Martellato offers a full range of edible cake food colouring available in spray, powders or gel pastes ideal to decorate and add a splash of whimsy to cakes, ice-cream and other desserts.

VELVET SPRAY

I coloranti alimentari spray Velvet, a base di burro di cacao, offrono al semifreddo un decoro dall'effetto vellutato. L'articolo può essere spruzzato su tutte le superfici congelate: semifreddi, mousse, torte gelato, cioccolato, creme etc

The Velvet food colouring spray, made with cocoa butter, offer a velvety decor for semifreddi.

The product can be sprayed on all frozen surfaces: semifreddos, mousses, ice cream cakes, chocolate, creams, etc.



SPRAY VELVET - CONSIGLI D'USO:

Il prodotto su cui si spruzza il Velvet deve essere congelato.

Mantenere il prodotto ad una temperatura di 20/25°C per almeno 2 ore e agitare bene prima dell'uso. Spruzzare uno strato sottile ed omogeneo di prodotto sulla superficie congelata che si vuole trattare da una distanza di circa 15/20 cm ad intervalli regolari.

Ruotare costantemente il dolce mentre si spruzza la decorazione Velvet in modo da distribuire uniformemente il prodotto.

Si consiglia di pulire l'erogatore con acqua calda subito dopo l'uso.

VELVET SPRAY - DIRECTIONS FOR USE:

It is essential that the surface is frozen. Keep the product at 20/25°C for at least 2 hours. Shake well before use. Spray a thin, uniform layer on the product from a distance of about 15-20 cm at regular intervals.

Constantly rotate the cake while decorating with Velvet to evenly distribute the product.

It is advisable to clean the nozzle with hot water right after use.

DOVE USARLO

- semifreddi
- gelati
- mousse
- altre superfici congelate prima del trattamento

CREATED FOR

- semifreddos
- ice-creams
- mousses
- other frozen products

cod.	Colore	MI	Info
LCV000	Bianco - White	400 ml	Azo free
LCV001	Arancione - Orange	400 ml	Azo
LCV003	Azzurro - Sky blue	400 ml	Azo free
LCV004	Giallo - Yellow	400 ml	Azo
LCV005N	Cioccolato al Latte - Milk choc.	400 ml	Azo
LCV107	Fucsia - Fuchsia	400 ml	Azo
LCV008	Rosso - Red	400 ml	Azo
LCV009N	Verde - Green	400 ml	Azo
LCV015N	Cioccolato fondente - Dark choc.	400 ml	Azo

SPRAY IDROALCOLICI - CONSIGLI D'USO:

Agitare il prodotto prima dell'uso, mantenersi ad una distanza di circa 15 cm.

Non spruzzare in quantità eccessiva per non rischiare di causare macchie indesiderate.

Lasciare asciugare per qualche secondo prima di spruzzare nuovamente sul prodotto da decorare.

HYDROALCOHOLIC SPRAY - DIRECTIONS FOR USE:

Shake the product before use, keep at a distance of about 15 cm. Do not spray too much in order to avoid unwanted stains. Allow to dry for a few seconds before spraying again on the product to be decorated.

DOVE USARLO

- masse grasse
- cioccolato
- marzapane
- biscotteria
- cialde
- zucchero tirato soffiato e colato
- pasta di zucchero
- semifreddi
- mousse
- gelato
- pastigliaggio
- pasticceria generale

CREATED FOR

- fat masses
- chocolate
- marzipan
- biscuits
- wafers
- pulled, blown and melted sugar
- sugar paste
- semifreddos
- mousse
- ice-creams
- pastillages
- general pastry

PEARL SPRAY COLOURING

Coloranti alimentari perlati **idroalcolici** in bombolette spray.

Ideali per la colorazione di masse grasse, cioccolato, marzapane, biscotteria, cialde, zucchero tirato soffiato e colato, pasta di zucchero, semifreddi, mousse, gelato, pastigliaggio e pasticceria generale.

Pearled **hydroalcoholic** food colouring in spray cans.

Ideal for the decoration of fat masses, chocolate, marzipan, biscuits, waffles, pulled sugar, candy floss, poured sugar, sugar paste, semifreddos, mousses, ice-cream, pastry in general.

cod.	Colore	Gr	Info
LCS215	Bronzo - Bronze	100 ml	Azo free
LCS217N	Oro - Gold	100 ml	Azo free
LCS218N	Rubino - Ruby	100 ml	Azo free
LCS219N	Argento - Silver	100 ml	Azo free
LCS220	Rame - Copper	100 ml	Azo free



PASTEL SPRAY COLOURING

Coloranti alimentari pastello **idroalcolici** in bombolette spray.

Ideali per la colorazione di masse grasse, cioccolato, marzapane, biscotteria, cialde, zucchero tirato soffiato e colato, pasta di zucchero, semifreddi, mousse, gelato, pastigliaggio e pasticceria generale.

Pastel **hydroalcoholic** food colors in spray cans.

Ideal for the decoration of fat masses, chocolate, marzipan, biscuits, waffles, pulled sugar, candy floss, poured sugar, sugar paste, semifreddi, mousses, ice-cream, pastry in general.

cod.	Colore	ml	Info
LCS001	Aranzone - Orange	100 ml	Azo
LCS003	Azzurro - Sky blue	100 ml	Azo free
LCS004	Giallo - Yellow	100 ml	Azo
LCS005	Bruno - Brown	100 ml	Azo
LCS007	Rosa - Pink	100 ml	Azo free
LCS008	Rosso - Red	100 ml	Azo
LCS009	Verde - Green	100 ml	Azo



IDROALCOLICI AEROGRAFO - CONSIGLI D'USO:

Agitare bene il flacone prima dell'uso e rimuovere i pigmenti che si depositano nel fondo con l'aiuto di un bastoncino. Se utilizzato con aerografo nebulizzare a circa 10 cm. Il prodotto può essere usato per colorare l'interno dello stampo, o direttamente sulla superficie di cioccolato a soggetto finito.

AIRBRUSH HYDROALCOHOLIC - DIRECTIONS FOR USE:

Shake the bottle well before use and remove the pigments that are deposited in the bottom with the help of a stick. When used with the airbrush, keep 10 cm distance from the chocolate figure. It can be used directly on the mould or on the finished chocolate figure.

SPECIAL FOR CHOCOLATE

DOVE USARLO

- masse grasse
- cioccolato
- marzapane
- biscetteria
- cialde
- pasta di zucchero
- pasta mandorle
- glasse

CREATED FOR

- fat masses
- chocolate
- marzipan
- biscuits
- wafers
- sugar paste
- almond paste
- icings

SATIN COLOURING AIRBRUSH

Il colorante alimentare "Satinato per Aerografo" è un prodotto **idroalcolico** con capacità coprente, adatto in particolar modo alla colorazione del cioccolato e pasta zucchero. **Dona un effetto satinato opaco.** The "Satin for Airbrush" colouring is a **hydroalcoholic** product that can easily cover chocolate or sugar paste. **It gives a matt effect.**



cod.	Colore	Gr	Info
LCA300	Bianco - White	60 gr	Azo free
LCA303	Azzurro - Skyblue	60 gr	Azo free
LCA304	Giallo - Yellow	60 gr	Azo free
LCA307	Rosa - Pink	60 gr	Azo free
LCA308	Rosso - Red	60 gr	Azo free
LCA309	Verde - Green	60 gr	Azo free

cod.	Colore	Gr	Info
40-WCA301	Arancio - Orange	40gr	Azo free
40-WCA303	Azzurro - Skyblue	40gr	Azo free
40-WCA304	Giallo - Yellow	40gr	Azo free
40-WCA306	Nero - Black	40gr	Azo free
40-WCA308	Rosso - Red	40gr	Azo free
40-WCA326	Verde lime - Lime green	40gr	Azo free



PEARL COLOURING AIRBRUSH

Il colorante alimentare "Perlato per Aerografo" è un prodotto **idroalcolico** con capacità coprente, adatto in particolar modo alla colorazione del cioccolato e pasta zucchero. **Dona un effetto perlato.** The "Air Brush Pearl" colouring is a **Hydroalcoholic** product that can easily cover chocolate or sugar paste. **It gives a pearlescent effect.**

cod.	Colore	Gr	Info
LCA408	Rosso - Red	100 gr	Azo free
LCA417	Oro - Gold	100 gr	Azo free
LCA419	Argento - Silver	100 gr	Azo free

cod.	Colore	Gr	Info
40-WCA417	Oro - Gold	40gr	Azo free
40-WCA419	Argento - Silver	40gr	Azo free



SHINY AIRBRUSH

Per la lucidatura e protezione di superfici a base di zucchero o cioccolato. To protect and polish sugar-based products or chocolate.

Cod.
LCAS100 Azo free 100 gr



IDROSOLUBILI AEROGRAFO - CONSIGLI D'USO:

Versare il colorante nel prodotto in base alla gradazione di colore che si vuole ottenere.

In caso di utilizzo del colorante con aerografo si consiglia, a lavoro terminato, di lavare la penna con acqua calda, qualora rimanesse residuo di colore secco utilizzare alcool a 90°.

AIRBRUSH WATER-SOLUBLE - DIRECTIONS FOR USE:

Pour the colouring in the product according to the shade of colour you want to obtain. In case of use of the colouring with an airbrush, it is recommended at the end of work to wash the pen with hot water. In case any residuals of colour remain, use alcohol at 90°.

DOVE USARLO

- marzapane
- biscotteria
- cialde
- zucchero tirato soffiato e colato
- pasta di zucchero
- semifreddi
- mousse
- gelato
- pastigliaggio
- pasticceria generale
- glasse
- panna
- pasta frolla

CREATED FOR

- marzipan
- biscuits
- wafers
- pulled, blown and melted sugar
- sugar paste
- semifreddo
- mousse
- ice-cream
- pastillages
- general pastry
- icings
- cream
- shortbread

PEARL COLOURING AIRBRUSH

Il colorante alimentare "Air Brush Pearl" è un prodotto **idrosolubile** adatto a qualsiasi tipo di impasto o alimento come: semifreddi, mousse, glasse, panna, pasta frolla, pasta di zucchero, pastigliaggio, marzapane e prodotti di pasticceria in genere. Dona un effetto perlescente alle superfici aerografate **Non è consigliato l'uso sul cioccolato o altre masse grasse.**

The food colouring "Air Brush Pearl" is a **water-soluble** product suitable for any type of dough or food such as ice creams, mousses, icings, cream, short pastry, sugarpaste, marzipan and pastries in general. Gives a pearlescent effect to surfaces decorated with airbrush. **It's not recommended for use on chocolate or other fat masses.**

cod.	Colore	Gr	Info	cod.	Colore	Gr	Info
LCA201	Arancione - Orange	190 gr	Azo	40-WC617	Oro - Gold	45 gr	Azo free
LCA203	Azzurro - Sky blue	190 gr	Azo free	40-WC619	Argento - Silver	45 gr	Azo free
LCA205	Marrone - Brown	190 gr	Azo				
LCA206	Nero - Black	190 gr	Azo				
LCA207N	Rosa - Pink	190 gr	Azo				
LCA208N	Rosso - Red	190 gr	Azo				
LCA209	Verde - Green	190 gr	Azo				
LCA210	Viola - Violet	190 gr	Azo				
LCA211	Limone - Lemon	190 gr	Azo				
LCA212	Pistacchio - Pistachio	190 gr	Azo				
LCA217	Oro - Gold	190 gr	Azo free				
LCA219	Argento - Silver	190 gr	Azo free				



PASTEL COLOURING AIRBRUSH

Il colorante alimentare **idrosolubile** "Air Brush" è adatto a qualsiasi tipo di impasto o alimento come: semifreddi, mousse, glasse, panna, pasta frolla, pasta di zucchero, pastigliaggio, marzapane e prodotti di pasticceria in genere. **Non è consigliato l'uso sul cioccolato o altre masse grasse.**

The **water-soluble** food colouring "Air Brush" is suitable for any type of dough or food such as ice cream, mousses, icings, cream, shortpastry, sugarpaste, marzipan and pastries in general. **It's not recommended for use on chocolate or other fat masses.**

cod.	Colore	Gr	Info	cod.	Colore	Gr	Info
40-WC600	Bianco - White	45 gr	Azo free	LCA000	Bianco - White	190 gr	Azo free
40-WC601	Arancione - Orange	45 gr	Azo	LCA001	Arancione - Orange	190 gr	Azo
40-WC602	Blu - Blue	45 gr	Azo free	LCA002	Blu - Blue	190 gr	Azo free
40-WC603	Azzurro - Sky blue	45 gr	Azo free	LCA003	Azzurro - Sky blue	190 gr	Azo free
40-WC604	Giallo - Yellow	45 gr	Azo	LCA004	Giallo - Yellow	190 gr	Azo
40-WC605	Marrone - Brown	45 gr	Azo	LCA005	Marrone - Brown	190 gr	Azo
40-WC606	Nero - Black	45 gr	Azo	LCA006	Nero - Black	190 gr	Azo
40-WC607	Rosa - Pink	45 gr	Azo	LCA007N	Rosa - Pink	190 gr	Azo
40-WC608	Rosso - Red	45 gr	Azo	LCA008N	Rosso - Red	190 gr	Azo
40-WC609	Verde - Green	45 gr	Azo	LCA009	Verde - Green	190 gr	Azo
40-WC610	Viola - Violet	45 gr	Azo	LCA010	Viola - Violet	190 gr	Azo
40-WC611	Limone - Lemon	45 gr	Azo	LCA011	Limone - Lemon	190 gr	Azo
40-WC612	Pistacchio - Pistachio	45 gr	Azo	LCA012	Pistacchio - Pistachio	190 gr	Azo



POLVERE LIPOSOLUBILE - CONSIGLI D'USO:

Il colorante è solubile in alcool, operazione consigliata o in acqua operazione più faticosa. Grazie alla capacità di riflettere la luce dona alla decorazione un effetto metallizzato.

Può essere usato direttamente sulla superficie di cioccolato, senza essere sciolto, con un pennello o con le dita ottenendo così un effetto perlato.

Per la colorazione in superficie si può utilizzare la polvere mischiata alla gommalacca liquida, in modo che il prodotto aderisca bene alla superficie una volta decorata.

DOVE USARLO

- cioccolato
- cioccolato bianco
- crema,
- pasta di zucchero
- pasta da modellaggio
- pasta di mandorle
- burro

CREATED FOR

- chocolate
- white chocolate
- custard
- sugar paste
- modelling paste
- almond paste
- butter

LIPOSOLUBLE POWDER - DIRECTIONS FOR USE:

The colouring is soluble in alcohol (suggested operation) or in water (more difficult operation). Thanks to the ability to reflect the light, this powder gives the decoration a metallic effect.

It can be used directly on the surface of chocolate, without being dissolved, with a brush or with fingers obtaining in this way a pearled effect to colour the surface you can use the powder mixed with the liquid shellac, so that the product adheres well to the surface once decorated.

PEARLED POWDER COLOURING

Il colorante alimentare in polvere **liposolubile e alcool solubile**, può essere usato per la decorazione di praline e soggetti di cioccolato, torte glassate, semifreddi, gelato, mousse, gelatina trasparente ecc.

The food **liposoluble** and **alcohol soluble** powder colouring can be used for decorating pralines or other figures of chocolate, frozen cakes, semifreddos, ice cream, mousse, transparent gelatin.



cod.	Colore	Gr	Info
40-WC015	Bronzo - Bronze	5 gr	Azo free
40-WC017	Oro lustre - Gold	5 gr	Azo free
40-WC020	Rame - Copper	5 gr	Azo free
40-WC119	Argento - Silver	5 gr	Azo free

cod.	Colore	Gr	Info
LCP003	Blu - Blue	25 gr	Azo free
LCP008	Rosso - Red	25 gr	Azo free
LCP009	Verde - Green	25 gr	Azo free
LCP010	Viola - Violet	25 gr	Azo free
LCP015	Bronzo - Bronze	25 gr	Azo free
LCP017N	Gold LUSTRE	25 gr	Azo free
LCP018	Rubino - Ruby	25 gr	Azo free
LCP019N	Silver LUSTRE	25 gr	Azo free
LCP020	Rame - Copper	25 gr	Azo free
LCP021	Fucsia - Fuchsia	25 gr	Azo free
LCP117	Oro - Gold	25 gr	Azo free
LCP119	Argento - Silver	25 gr	Azo free



INTERFERENCE POWDER

Il colorante alimentare in polvere **liposolubile**, se associate ad una superficie scura, donano dei riflessi di luce colorata. Possono essere usate su soggetti di cioccolato fondente o paste zucchero colorate.

The food colouring powders **liposoluble**, when applied on a dark surface, give some coloured light reflections. They can be used on dark chocolate figures or coloured sugar paste.

cod.	Colore	Gr	Info
40-WCP508	Rossa - Red	5gr	Azo free
40-WCP517	Oro - Gold	5gr	Azo free



PASTEL POWDER COLOURING

Il colorante alimentare **liposolubile** può essere utilizzato in tutte le masse grasse come cioccolato, burro di cacao, pasta frolla, marzipane, pasta di zucchero etc..

The food **liposoluble** colouring can be used in all fat masses: chocolate, cocoa butter, short pastry, marzipan, sugar paste.

cod.	Colore	Gr	Info	cod.	Colore	Gr	Info
40-WC300	Bianco - White	5 gr	Azo free	LCP300	Bianco - White	25 gr	Azo free
40-WC302	Blu - Blue	5 gr	Azo free	LCP302	Blu - Blue	25 gr	Azo free
40-WC304	Giallo - Yellow	5 gr	Azo free	LCP304	Giallo - Yellow	25 gr	Azo
40-WC305	Marrone - Brown	5 gr	Azo free	LCP305	Marrone - Brown	20 gr	Azo
40-WC306	Nero - Black	5 gr	Azo free	LCP306	Nero - Black	25 gr	Azo free
40-WC307	Rosa - Pink	5 gr	Azo free	LCP307	Rosa - Pink	25 gr	Azo free
40-WC308	Rosso - Red	5 gr	Azo free	LCP308	Corallo - Coral	25 gr	Azo
40-WC309	Verde - Green	5 gr	Azo free	LCP308N	Rosso - Red	25 gr	Azo
40-WC310	Viola - Violet	5 gr	Azo free	LCP309	Verde - Green	25 gr	Azo
40-WC311	Arancione - Orange	5 gr	Azo free	LCP311	Arancione - Orange	25 gr	Azo
40-WC322	Candy pink	5 gr	Azo free				



POLVERE IDROSOLUBILE - CONSIGLI D'USO:

Il colorante può essere sciolto con l'aggiunta di acqua.

La grana più fine facilita e velocizza lo scioglimento della polvere.

IDROSOLUBLE POWDER - DIRECTIONS FOR USE:

The colouring can be dissolved with the addition of water.

The finer is the grain the faster is the dissolution of the powder.

DOVE USARLO

- panna
- pasta di zucchero
- pasta da modellaggio
- semifreddi
- ghiaccia
- pastafrolla
- macarons
- meringhe

CREATED FOR

- cream
- sugar paste
- modelling paste
- semifreddo
- icing
- shortbread
- macarons
- meringues

PASTEL POWDER COLOURING

Colorante alimentare in polvere **idrosolubile** ad elevato grado di purezza, utilizzabile in qualsiasi tipo di impasto (per la colorazione del cioccolato si consiglia di utilizzare la linea "Lake Powder" o "Pearled Powder").

High purity **water-soluble** food colouring powder to be used in any type of dough (to colour chocolate you should use the line "Lake Powder" or "Pearled Powder").

cod.	Colore	Gr	Info
LCP202	Blu - Blue	25 gr	Azo free
LCP204	Giallo - Yellow	25 gr	Azo
LCP206	Nero - Black	25 gr	Azo free
LCP208	Rosso - Red	25 gr	Azo
LCP209	Verde - Green	25 gr	Azo
LCP211	Arancione - Orange	25 gr	Azo
LCP218	Fragola - Strawberry	25 gr	Azo



COCOA BUTTER

I coloranti a base di burro di cacao, una volta sciolti a bagnomaria o microonde, risultano perfetti per la colorazione di prodotti di cioccolato e altre masse grasse.

Colourings made of cocoa butter, once melted in bain-marie or microwave, are perfect to colour chocolate products.

cod.	Colore	Gr	Info	cod.	Colore	Gr	Info
LCB200	Bianco - White	200 gr	Azo free	40-WCB200	Bianco - White	30 gr	Azo free
LCB201	Arancio - Orange	200 gr	Azo	40-WCB201	Arancio - Orange	30 gr	Azo
LCB202	Blu - Blue	200 gr	Azo free	40-WCB202	Blu - Blue	30 gr	Azo free
LCB204	Giallo - Yellow	200 gr	Azo	40-WCB204	Giallo - Yellow	30 gr	Azo
LCB206	Nero - Black	200 gr	Azo	40-WCB206	Nero - Black	30 gr	Azo
LCB208	Rosso - Red	200 gr	Azo	40-WCB208	Rosso - Red	30 gr	Azo
LCB209	Verde - Green	200 gr	Azo	40-WCB210	Viola - Violet	30 gr	Azo
LCB210	Viola - Violet	200 gr	Azo	40-WCB217	Oro - Gold	30 gr	Azo free



BURRO CACAO - CONSIGLI D'USO:

Il burro di cacao può essere utilizzato puro per piccole decorazioni con il pennello oppure, se diluito con 50% di cioccolato bianco, può essere spruzzato con pistola a caldo producendo così un effetto vellutato. Spruzzato all'interno di stampi per praline o corpi cavi, sciolto a 30°C oltre a colorare, permette di ottenere un effetto maculato, neve, goccia o buccia d'arancia.

DOVE USARLO

- cioccolato
- masse grasse

CREATED FOR

- chocolate
- fat masses

COCOA BUTTER - DIRECTIONS FOR USE:

The product when sprayed with hot gun, mixed with 50% of white chocolate, produces a velvety effect. Sprayed into moulds for chocolates, melted at 30°C, in addition to colour, allows to get spotted, snow, drop or orange peel effect.

GEL COLOURING

Colorante in gel ad altissima concentrazione, speciale per le colorazioni di pasta zucchero, masse grasse e royal ice.

Highly concentrated colouring in gel to colour of sugar paste, fat masses and royal icing.

cod.	Colore	Gr	Info	cod.	Colore	Gr	Info
LCG001	Arancione - Orange	30gr	Azo	LCG008	Rosso - Red	30gr	Azo
LCG002	Blu - Blue	30gr	Azo free	LCG009	Verde - Green	30gr	Azo
LCG004	Giallo - Yellow	30gr	Azo	LCG010	Violet - Violet	30gr	Azo
LCG005	Marrone - Brown	30gr	Azo	LCG022	Blue Navy	30gr	Azo
LCG006	Nero - Black	30gr	Azo	LCG025	Incarnato - Incarnate	30gr	Azo
LCG007	Rosa - Pink	30gr	Azo				



JELLIES

La gelatina ad uso alimentare è ideale per guarnire le torte e dare un effetto di lucentezza. Food jellies are ideal to garnish every kind of cake.

CONSIGLI D'USO:

Una volta ammorbidita con la frusta, la gelatina va stesa sulla superficie della torta per dare un effetto lucido e glassato.

DIRECTIONS FOR USE:

Soften the jelly with a whisk, and then spread it onto the cake surface to produce a shiny effect.

cod.	Colore	Gr	Info
LCJ000	Trasparente - Transparent	1000 gr	Azo free
LCJ100	Glitter - Glitter Transparent	1000 gr	Azo free



SPRAY SPECIALI - CONSIGLI D'USO:

Agitare la bomboletta e spruzzare uniformemente ad una distanza di circa 15-20 cm.

SPECIAL SPRAY - DIRECTIONS FOR USE:

Shake the can and spray evenly at a distance of about 15-20 cm

MARZIPAN SHINY

Cod. **LCV100**
Azo free 400 ml

Lucidante alimentare neutro a base di burro di cacao ideale per proteggere e lucidare marzapane e pasta di mandorle.

Neutral Food Polishing composed of cocoa butter, ideal to protect and polish marzipan and almond paste



COOLER

Cod. **EUROCHOCK**
Azo free 400 ml

Refrigerante in spray, con cannuccia unidirezionale, per la presa istantanea di particolari in cioccolato o zucchero.

Spray cooler, with monodirection straw, enables to fix chocolate and sugar pieces.



COATING

Cod. **COATING**
Azo free 400 ml

Staccante alimentare ideale per velocizzare la rimozione del prodotto da teglie o cinture in acciaio e alluminio, stampi semifreddo, termoformati o altro. Il prodotto è inodore e insapore.

Detaching ideal to remove easily the product from mould trays, steel belts, aluminium moulds, thermoformed moulds and other. The product is odourless and tasteless.



SHINY

Cod. **LCS200**
Azo free 400 ml

Per la lucidatura e protezione di superfici a base di zucchero o cioccolato.

To protect and polish sugar-based products or chocolate.



PLASTIC MASKS



In materiale plastico per alimenti.
 Misure: Ø260mm. Spessore 8/10.
 Made of food safe plastic.
 Sizes: Ø260mm. Thickness 8/10.



MASK 194



MASK 195

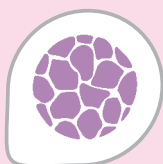

MASK 196



MASK 197



MASK 198

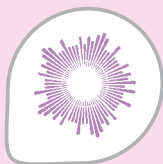

MASK 199



MASK 200

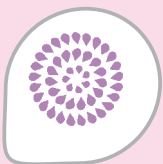

MASK 201



MASK 202



MASK 203



MASK 204



MASK 1



MASK 2



MASK 5



MASK 6



MASK 7



MASK 8



MASK 9



MASK 10



MASK 11



MASK 12



MASK 13



MASK 14



MASK 15



MASK 18

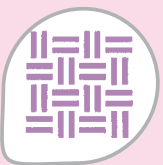

MASK 19



MASK 21



MASK 22



MASK 24



MASK 26



MASK 27



MASK 28

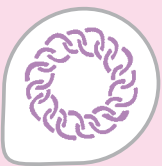

MASK 30



MASK 32



MASK 34

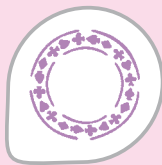

MASK 35



MASK 38



MASK 39



MASK 40



MASK 41



MASK 43



MASK 44



MASK 45



MASK 47



MASK 48



MASK 49



MASK 50



MASK 53



MASK 54



MASK 56



MASK 57



MASK 58



MASK 61



MASK 62



MASK 64



MASK 65



MASK 66



MASK 67



MASK 68



MASK 69



MASK 72



MASK 74



MASK 75



MASK 76



MASK 80



MASK 85



MASK 86



MASK 87



MASK 88



MASK 90



MASK 91



MASK 92



MASK 94



MASK 95



MASK 97



MASK 98



MASK 101



MASK 103



MASK 104



MASK 107



MASK 108



MASK 109



MASK 110



MASK 112



MASK 114



MASK 115



MASK 116



MASK 118



MASK 120



MASK 121



MASK 122



MASK 123



MASK 124



MASK 125



MASK 126



MASK 128



MASK 129



MASK 130



MASK 131



MASK 134



MASK 135



MASK 136



MASK 137



MASK 138



MASK 140



MASK 141



MASK 145



MASK 157



MASK 147



MASK 148



MASK 149



MASK 151



MASK 154



MASK 159



MASK 172



MASK 161



MASK 162



MASK 163



MASK 164



MASK 166



MASK 170



MASK 174



MASK 182



MASK 176



MASK 177



MASK 178



MASK 179



MASK 180



MASK 181



MASK 185



MASK 189



Stencil porzionatore - Cake marker stencil

Griglia tiramisù per decorare il dolce e segnare le porzioni.
Tiramisù grill to decorate the cake and mark portions.

Cod. **GPO22**
40x30cm



MINI STENCILS

In materiale plastico per alimenti.
 Misure: Ø95mm. Spessore 8/10.
 Made of food safe plastic.
 Sizes: Ø95mm. Thickness 8/10.

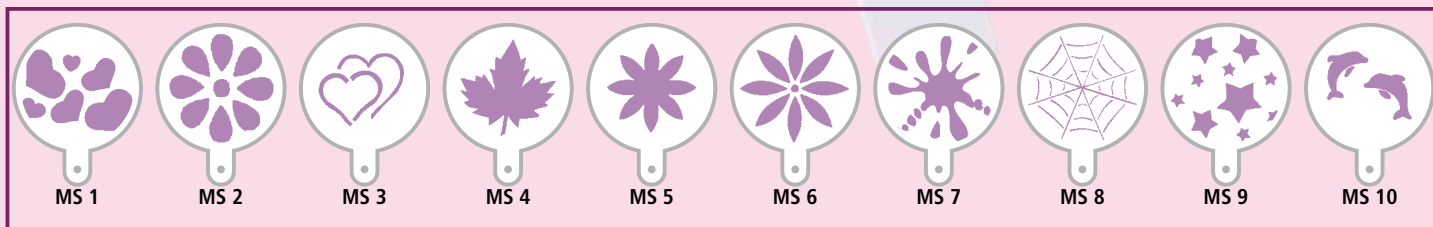

Cod. **KITMS1**
 Kit 10 pcs

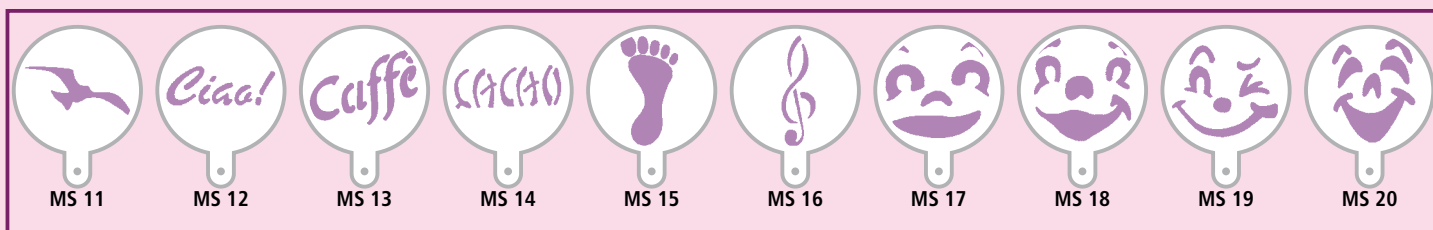

Cod. **KITMS2**
 Kit 10 pcs

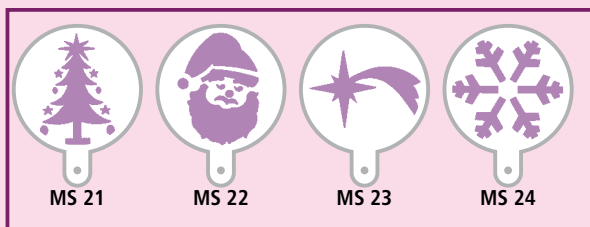

Cod. **KITMS3**
 Kit 5 pcs

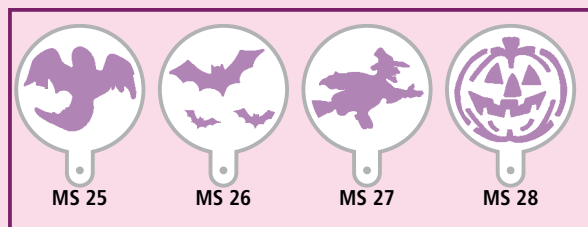

Cod. **KITMS4**
 Kit 5 pcs

Mini setaccio - Mini sifter

Cod. **SETACIOK**
 Ø70 h90mm
 Acciaio inox. - St. steel.



CREATIVE STENCILS

Stencil in plastica bianca.
White plastic stencil.
Misura - Size 295x200mm

Cod. **PMFORK**
30x125 x h1,5mm
12pcs



Cod. **PMSPOON**
30x130 x h1,5mm
12pcs



Cod. **PMKNIFE**
20x130 x h1,5mm
14pcs



Stencil plastica trasparente.
Trasparent plastic stencil.
Misura - Size 310x510mm



Cod. **SCSP01**
130x30 x h2mm
30pcs



Cod. **SCSP03**
75x35x h2mm
40pcs



Cod. **SCSP04**
65x40 x h2mm
32pcs



Set 5 pezzi
di diverso diametro.
Set 5 pcs
with different diameter.



Cod. **PM 5 AZ**
Ø 60 - 170 mm



Cod. **PM 5 DA**
Ø 60 - 170 mm



Cod. **PM 5 ET**
Ø 60 - 170 mm



Cod. **PM 5 FO**
Ø 60 - 170 mm



Cod. **PM 5 MA**
Ø 60 - 180 mm



Cod. **PM 5 PA**
Ø 60 - 170 mm



Cod. **PM 5 PR**
Ø 60 - 170 mm

RELIEF MATS

Tappeto in silicone per decori in rilievo. Le stuoie permettono di ottenere decori in rilievo a 1 o 2 colori, in un'unica operazione di surgelazione e cottura.
Misura: 60 x 40 cm.

Relief silicone mats for baking. Create beautiful designs for your cakes and dessert with these new bakeable and freezable decorative mats.
Size: 60 x 40 cm



Cod. **RELIEF1**
Misura - Size: h 37mm



Cod. **RELIEF2**
Misura - Size: Ø 4mm



Cod. **RELIEF3**
Misura - Size: h 47mm



Cod. **RELIEF4**
Misura - Size: h 30mm



Cod. **RELIEF5**
Misura - Size: h 30mm



Cod. **RELIEF6**
Misura - Size: h 30mm



Cod. **RELIEF7**
Misura - Size: h 30mm



Cod. **RELIEF8**
Misura - Size: h 30mm



Cod. **RELIEF9**
Misura - Size: h 30mm



Cod. **RELIEF10**
Misura - Size: h 30mm



Cod. **RELIEF11**
Misura - Size: h 30mm



Cod. **RELIEF12**
Misura - Size: h 30mm



HOW TO USE

- 1 - Stendere la pasta sigaretta nel tappeto in silicone. Passare 5 minuti in congelatore.
- 2 - Stendere il biscuit.
- 3 - Cuocere in forno a 220° C per circa 10/12 minuti.
- 4 - Appoggiare il biscuit capovolto su un foglio e togliere delicatamente il tappeto.



1



2



3

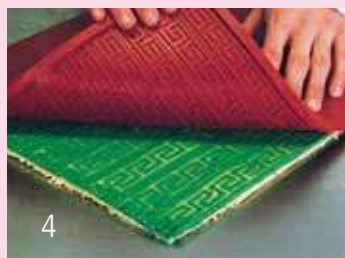

4

- 1 - Spread the cigarette dough on the silicone mat. Put it in a freezer for 5 min.
- 2 - Spread the biscuit (joconde).
- 3 - Bake in the oven at 220° C for 10/12 min.
- 4 - Place the biscuit upside down on some grease-proof paper and remove the silicone sheet carefully.

RELIEF COMBS

Pettini in materiale plastico con doppio decoro.
Ideali per il biscuit decorato e per stendere la pasta sigaretta.
Plastic combs with double decoration.
Suitable for preparing biscuit and spreading "cigarette paste".



cod. **PD1/2** 70cm
cod. **PDM1/2** 34cm
cod. **PDS1/2** 17cm

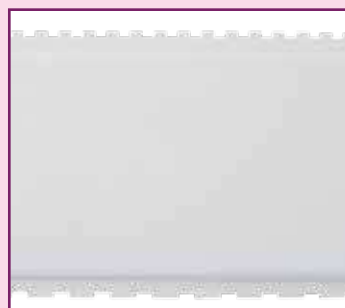

cod. **PD3/4** 70cm
cod. **PDM3/4** 34cm
cod. **PDS3/4** 17cm

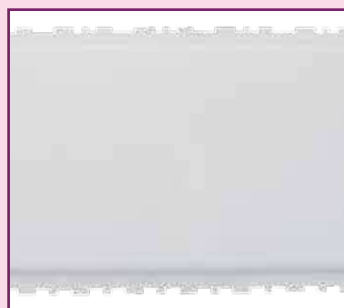

cod. **PD5/6** 70cm
cod. **PDM5/6** 34cm
cod. **PDS5/6** 17cm



cod. **PD7/8** 70cm
cod. **PDM7/8** 34cm
cod. **PDS7/8** 17cm

scale 1:1

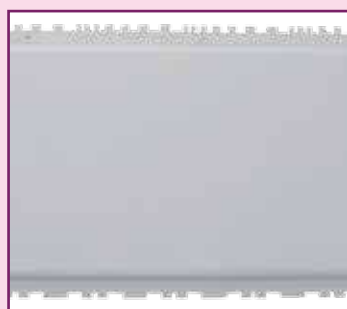
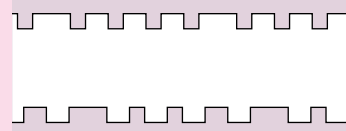
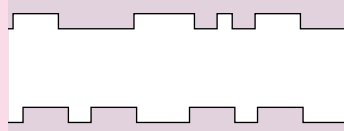
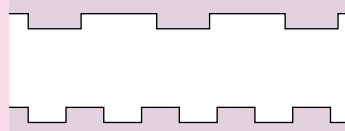
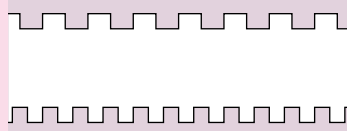

cod. **PD9/10** 70cm
cod. **PDM9/10** 34cm
cod. **PDS9/10** 17cm

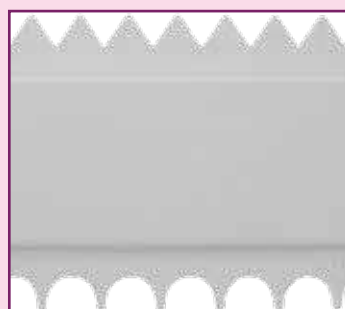

cod. **PD13/14** 70cm
cod. **PDM13/14** 34cm
cod. **PDS13/14** 17cm

scale 1:1

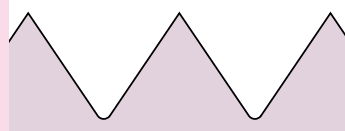
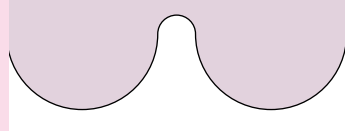
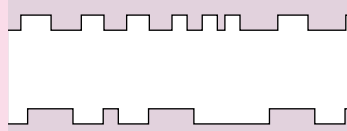

Pettine 3 colori - Comb 3 colours

Pettini in materiale plastico per triplo decoro.
Plastic combs for triple decoration.

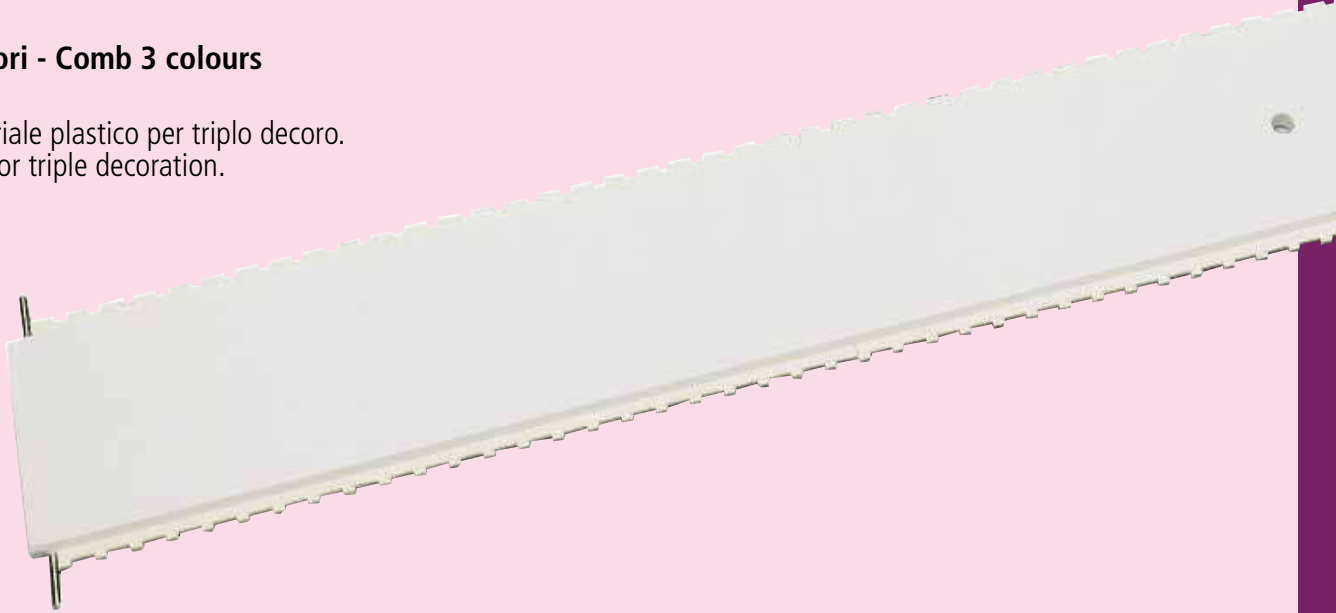

Cod. **PD11/12**
70cm

scale 1:1

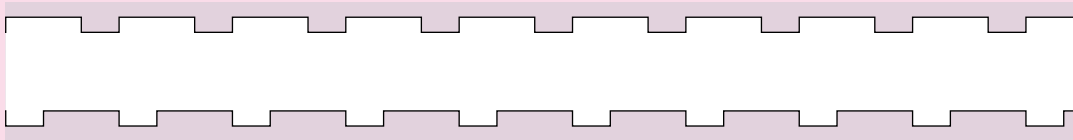

Tampone effetto legno - Wood comb

In polipropilene per decorazioni in cioccolato.
Made of polypropylene. For chocolate decorations.

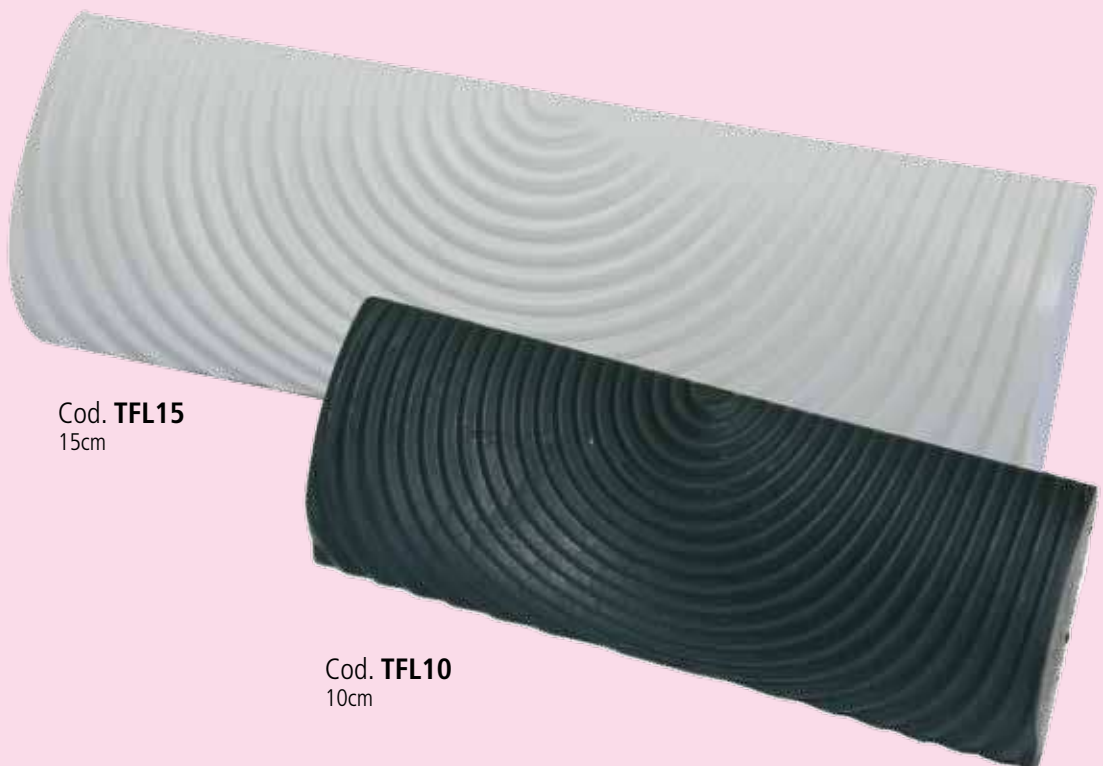

Cod. **TFL15**
15cm

Cod. **TFL10**
10cm

DECORATION GRILLS

Griglie in materiale plastico per biscuit decorato e altre decorazioni.
Plastic grills for decorated biscuit and other decorations.



HOW TO USE



Appoggiare la griglia su di un foglio in silicone.

- 1 - Spatolare la pasta decoro uniformemente.
- 2 - Togliere la griglia e passare il decoro realizzato in congelatore.
- 3 - Stendere il biscuit aiutandosi con una cornice e una spatola.

Cuocere in forno a 230° C per 8 minuti.

Appoggiare il biscuit capovolto su un foglio e togliere delicatamente il tappeto in silicone. Tagliare le fasce di biscuit nella larghezza desiderata utilizzando il tagliapasta estendibile. Mettere le fasce di biscuit così ottenute nella forma prescelta.

Place the grill on a silicone sheet.

- 1 - Spread the decorating paste.
- 2 - Take off the grill and put into refrigerator.
- 3 - Afterwards spread the biscuit using a frame and a spatula.

Bake in the oven at 230° C for 8 minutes.

Place the biscuit upside down on a greaseproof paper and remove carefully the silicone sheet. Using an extensible pastry cutter, cut the biscuit into stripes. Now you can put the stripes into the mould you prefer.

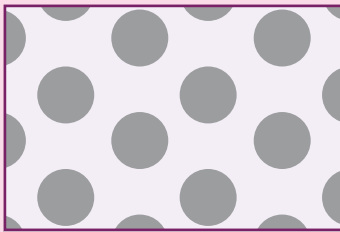

cod. **GS01** 30x20cm
cod. **GD01** 60x40cm

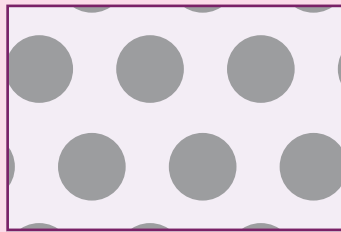

cod. **GS02** 30x20cm
cod. **GD02** 60x40cm

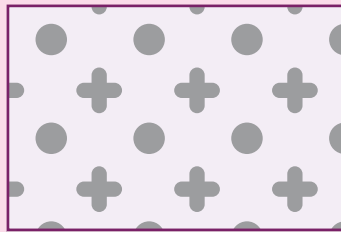

cod. **GS03** 30x20cm
cod. **GD03** 60x40cm

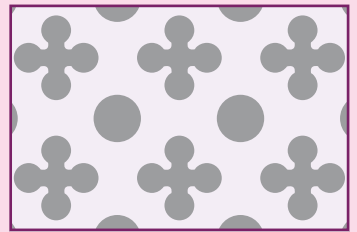

cod. **GS04** 30x20cm
cod. **GD04** 60x40cm

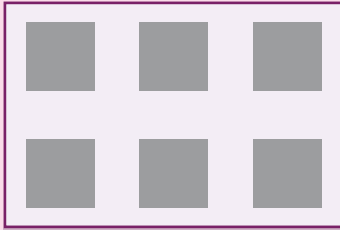

cod. **GS05** 30x20cm
cod. **GD05** 60x40cm

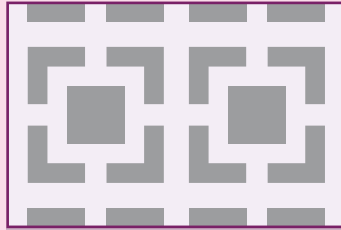

cod. **GS06** 30x20cm
cod. **GD06** 60x40cm

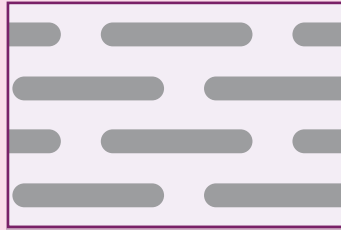

cod. **GS07** 30x20cm
cod. **GD07** 60x40cm

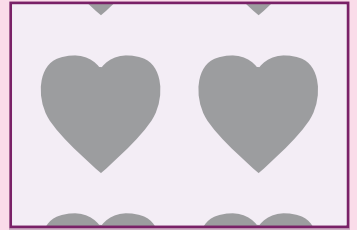

cod. **GS08** 30x20cm
cod. **GD08** 60x40cm

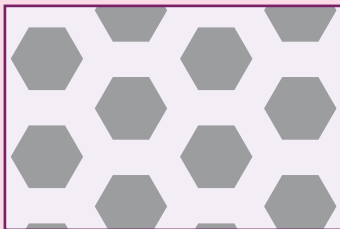

cod. **GS09** 30x20cm
cod. **GD09** 60x40cm

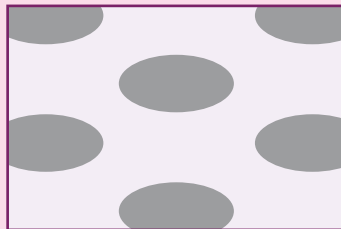

cod. **GS10** 30x20cm
cod. **GD10** 60x40cm

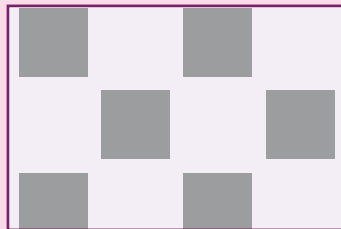

cod. **GS11** 30x20cm
cod. **GD11** 60x40cm



cod. **GS12** 30x20cm
cod. **GD12** 60x40cm

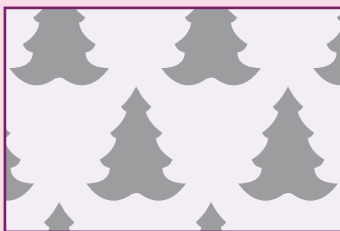

cod. **GS13** 30x20cm
cod. **GD13** 60x40cm



cod. **GS14** 30x20cm
cod. **GD14** 60x40cm



cod. **GS15** 30x20cm
cod. **GD15** 60x40cm

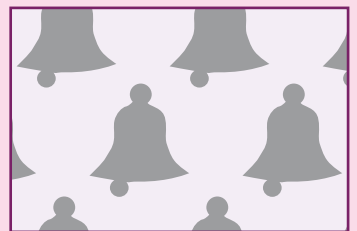

cod. **GS16** 30x20cm
cod. **GD16** 60x40cm

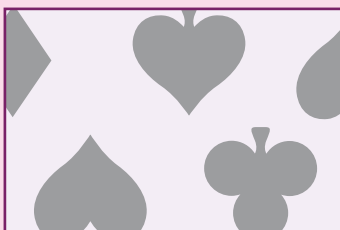

cod. **GS17** 30x20cm
cod. **GD17** 60x40cm



cod. **GS18** 30x20cm
cod. **GD18** 60x40cm



cod. **GS19** 30x20cm
cod. **GD19** 60x40cm

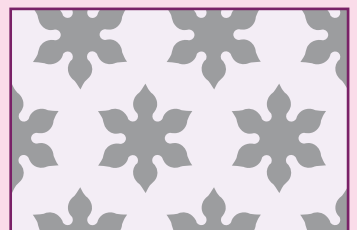

cod. **GS20** 30x20cm
cod. **GD20** 60x40cm



cod. **GS21** 30x20cm
cod. **GD21** 60x40cm

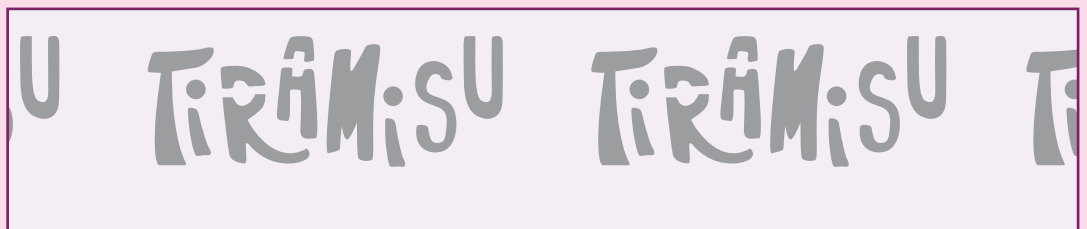

cod. **GS22** 30x20cm
cod. **GD22** 60x40cm

CARVING TOOLS & BOOKS

Valigette di attrezzi per intaglio di frutta e verdura.
Fruit and vegetable carving tools kit.



Cod. **DECO10T**
10 pcs



Cod. **DECO24W**
24 pcs

Libri professionali per decorazione - Professional books for decoration



Cod. **40-W109**
I/GB/ES

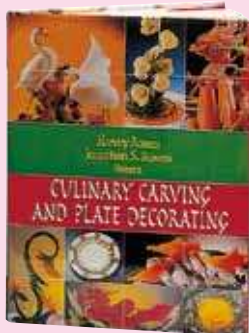

Cod. **DECO2**
GB



Cod. **SUGAR1**
ES/GB/FR/DE



Cod. **ARTISTIK2**
I/GB/FR/DE



Cod. **ARTISTIK3**
I/GB/FR/DE

Pinzette per decoro, in acciaio inox - Stainless steel pie crimpers

Kit 2 pezzi: una pinzetta piccola larga 12mm - una pinzetta grande larga 18mm.
Kit 2 pcs: one small crimper 12mm - one big crimper 18mm.



Cod. **001 OA D**
Dentellato - Serrated
Kit 2 pcs



Cod. **001 OA L**
Liscio - Plain
Kit 2 pcs



Cod. **002 OC D**
Dentellato - Serrated
Kit 2 pcs



Cod. **002 OC L**
Liscio - Plain
Kit 2 pcs



Cod. **003 VA D**
Dentellato - Serrated
Kit 2 pcs



Cod. **003 VA L**
Liscio - Plain
Kit 2 pcs



Cod. **004 VC D**
Dentellato - Serrated
Kit 2 pcs



Cod. **004 VC L**
Liscio - Plain
Kit 2 pcs



Cod. **005 CA D**
Dentellato - Serrated
Kit 2 pcs



Cod. **005 CA L**
Liscio - Plain
Kit 2 pcs



Cod. **006 CC D**
Dentellato - Serrated
Kit 2 pcs



Cod. **006 CC L**
Liscio - Plain
Kit 2 pcs



Cod. **007 LD D**
Dentellato - Serrated
Kit 2 pcs



Cod. **007 LD L**
Liscio - Plain
Kit 2 pcs



Cod. **008 CU D**
Dentellato - Serrated
Kit 2 pcs



Cod. **008 CU L**
Liscio - Plain
Kit 2 pcs



Cod. **009 AG D**
Dentellato - Serrated
Kit 2 pcs



Cod. **009 AG L**
Liscio - Plain
Kit 2 pcs



Cod. **010 LO D**
Dentellato - Serrated
Kit 2 pcs



Cod. **010 LO L**
Liscio - Plain
Kit 2 pcs

MARZIPAN EQUIPMENT

Le ottime finiture di ogni singolo attrezzo consentono di decorare con estrema cura e precisione tutti i dettagli del soggetto di marzapane. Realizzati in un unico pezzo per eliminare qualsiasi rischio di rottura.
The excellent quality of every single tool lets you decorate with the outmost care and precision all the details of marzipan figure. Composed of a single piece to eliminate any risk of breakage.

Cod. MARSET6

1 coltello - 2 raschietti - 6 bastoncini
1 knife - 2 scrapers - 6 tools



Cod. MARCUT1

1 coltello / 1 knife



Cod. 50WA006B

1 coltello / 1 knife



Cod. 50WA004B

1 valigetta - 1 coltello
1 raschietto - 12 bastoncini
1 case - 1 knife - 1 scraper - 12 tools

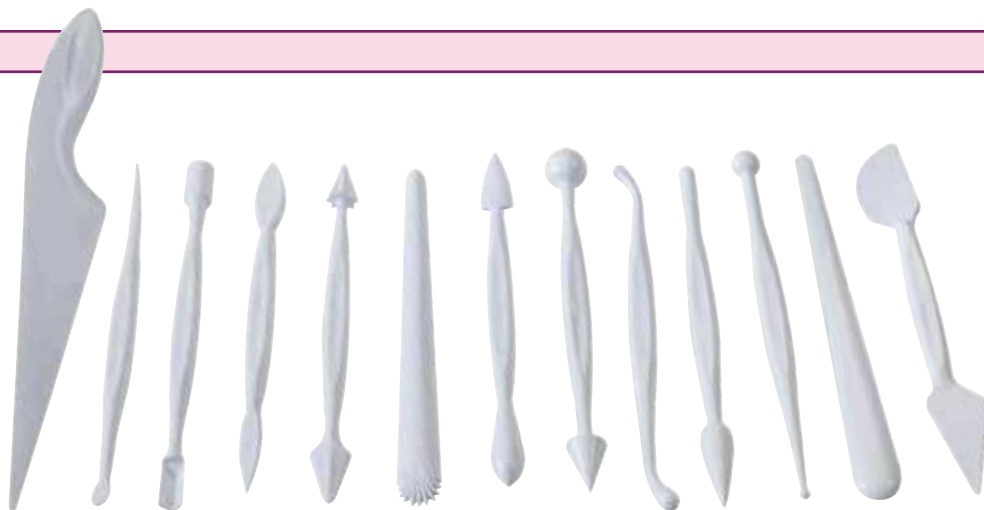

Cod. 50WA005B

1 valigetta - 1 coltello
1 raschietto - 12 bastoncini
1 case - 1 knife - 1 scraper - 12 tools



SPEEDY FORM

Stampo per una facile e veloce produzione di pasticcini. Kit composto da: stampo "Speedy form" cm 30x20, tavoletta, tagliapasta grande e piccolo.

Easy and speedy petit-fours moulds. Set composed of: Speedy form cm 30x20 mould, tray, big and small plastic cutter.

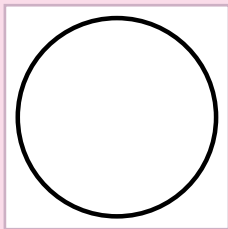

Cod. **SPEEDY1**
Ø40 h25mm

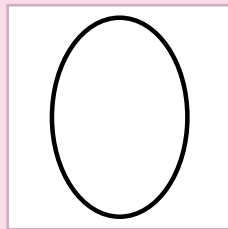

Cod. **SPEEDY2**
50x30 h25mm

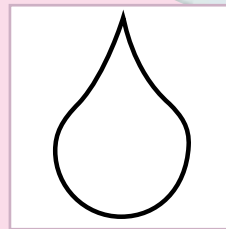

Cod. **SPEEDY3**
50x35 h25mm

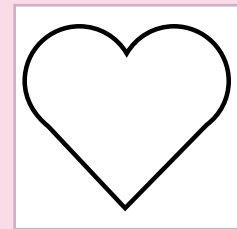

Cod. **SPEEDY4**
Ø45 h25mm

HOW TO USE



1 - Preparare un foglio di marzipane dello spessore di 2mm circa. Con il tagliapasta più grande tagliarne dei pezzi e appoggiarli in corrispondenza del foro. Premere il marzipane contro lo stampo facendolo ben aderire.

Spolverare di zucchero a velo lo stampo prima di appoggiarvi il marzipane.

2 - A questo punto si può riempire lo spazio vuoto con crema, panna, mousse, ecc.

3 - Coprire con il biscuit o il marzipane precedentemente tagliato con il tagliapasta piccolo in dotazione.

4 - Appoggiare sopra lo stampo la tavoletta piana in dotazione e capovolgere il tutto togliendo lo stampo.

5 - Dopo il montaggio decorare a piacere con ghiaccia o cioccolato.

6 - Utilizzare nuovamente il tagliapasta piccolo per eliminare i bordi superflui di marzipane.

1 - Prepare one marzipane sheet about 2mm thick. Cut the marzipan with the biggest plastic cutter. Put the pieces on the "Speedy form" mould stuffing the marzipan on the shape.

We suggest you to sprinkle the "Speedy form" with icing sugar before starting.

2 - Fill the empty shapes with creme, mousse, bavaois, etc...

3 - Cover with biscuit cut with the smallest plastic cutter.

4 - Lean the tray on the "Speedy form" mould, reverse it and remove the "Speedy form" mould.

5 - Decorate as you prefer.

6 - Eliminate the exceeding marzipan with the small plastic cutters.

DISPOSABLE GLASSES

JAPAN

Ø42 h43 mm

Cap. **47** ml



Cod. **PMOJA001**

Trasparente - Transparent

Pack 100 pcs

Packaging:

Scatola Avana - Cardboard box



Cod. **PMOJA0011600**

Trasparente - Transparent

Pack 16 pcs

Packaging:

Elegant box

Master: 24 box



Cod. **PMOTO001/C**

Ø 42 mm

Trasparente - Transparent

Pack 100 pcs

per PMOJA001

JAPAN

Ø50 h54 mm

Cap. **87** ml



Cod. **PMOJA002**

Trasparente - Transparent

Pack 100 pcs

Packaging:

Scatola Avana - Cardboard box



Cod. **PMOJA0021500**

Trasparente - Transparent

Pack 15 pcs

Packaging:

Elegant box

Master: 12 box



Cod. **PMOTO002/C**

Ø 50 mm

Trasparente - Transparent

Pack 100 pcs

per PMOJA002



VELA

63x69 h 57mm

Cap. **85ml**



Cod. **PMOCO011**

Trasparente - Transparent

Pack 100 pcs

Packaging:

Scatola Avana - Cardboard box

VELA

73x81 h 67mm

Cap. **140ml**



Cod. **PMOCO012**

Trasparente - Transparent

Pack 100 pcs

Packaging:

Scatola Avana - Cardboard box



Cod. **PMOCO0112000**

Trasparente - Transparent

Pack 20 pcs

Packaging:

Elegant box

Master: 12 box



Cod. **PMOCO0121800**

Trasparente - Transparent

Pack 18 pcs

Packaging:

Elegant box

Master: 24 box



WAFFLE

64x62 h 59mm

Cap. **70ml**



Cod. **PMOCO013**

Trasparente - Transparent

Pack 100 pcs

Packaging:

Scatola Avana - Cardboard box



Cod. **PMOCO0132000**

Trasparente - Transparent

Pack 20 pcs

Packaging:

Elegant box

Master: 12 box



SOFT ICE

Ø70 h 59mm

Cap. **105ml**



Cod. **PMOCO014**

Trasparente - Transparent

Pack 100 pcs

Packaging:

Scatola Avana - Cardboard box



Cod. **PMOCO0143000**

Trasparente - Transparent

Pack 30 pcs

Packaging:

Elegant box

Master: 12 box



Cod. **PMOCO002/C**

Ø 70 mm

Trasparente - Transparent

Pack 100 pcs

per PMOCO014



WAVE

64x46 h53 mm

Cap. **50** ml



Cod. **PMOCE001**

Trasparente - Transparent

Pack 100 pcs

Packaging:

Scatola Avana - Cardboard box

WAVE

85x60 h70 mm

Cap. **120** ml



Cod. **PMOCE002**

Trasparente - Transparent

Pack 100 pcs

Packaging:

Scatola Avana - Cardboard box



Cod. **PMOCE0011800**

Trasparente - Transparent

Pack 18 pcs

Packaging:

Elegant box

Master: 12 box



Cod. **PMOCE0021200**

Trasparente - Transparent

Pack 12 pcs

Packaging:

Elegant box

Master: 24 box





GREEK

Ø50 h 57mm

Cap. **50ml**



Cod. **PMOCO008**

Trasparente - Transparent

Pack 100 pcs

Packaging:

Scatola Avana - Cardboard box

GREEK

Ø73 h 61mm

Cap. **120ml**



Cod. **PMOCO009**

Trasparente - Transparent

Pack 100 pcs

Packaging:

Scatola Avana - Cardboard box

GREEK

Ø92 h 75mm

Cap. **190ml**



Cod. **PMOCO010**

Trasparente - Transparent

Pack 100 pcs

Packaging:

Scatola Avana - Cardboard box



Cod. **PMOCO0081800**

Trasparente - Transparent

Pack 18 pcs

Packaging:

Elegant box

Master: 12 box



Cod. **PMOCO0093000**

Trasparente - Transparent

Pack 30 pcs

Packaging:

Scatola bianca - White Cardboard box



Cod. **PMOCO0102000**

Trasparente - Transparent

Pack 20 pcs

Packaging:

Scatola bianca - White Cardboard box



CLASSIC

Ø42 h65 mm

Cap. **65** ml



Cod. **PMOTO001**

Trasparente - Transparent
Pack 100 pcs
Packaging:
sacchetto trasparente
transparent bag

Cod. **PMOTO001/24**

Trasparente - Transparent
Pack 24 pcs
Packaging:
sacchetto trasparente
transparent bag

Ø50 h65 mm

Cap. **90** ml



Cod. **PMOTO002**

Trasparente - Transparent
Pack 100 pcs
Packaging:
sacchetto trasparente
transparent bag

Cod. **PMOTO002/24**

Trasparente - Transparent
Pack 24 pcs
Packaging:
sacchetto trasparente
transparent bag

Ø55 h70 mm

Cap. **120** ml



Cod. **PMOTO003**

Trasparente - Transparent
Pack 100 pcs
Packaging:
sacchetto trasparente
transparent bag

Cod. **PMOTO003/24**

Trasparente - Transparent
Pack 24 pcs
Packaging:
sacchetto trasparente
transparent bag



Cod. **PMOTO0012000**

Trasparente - Transparent
Pack 20 pcs
Packaging:
Elegant box
Master: 24 box



Cod. **PMOTO0021500**

Trasparente - Transparent
Pack 15 pcs
Packaging:
Elegant box
Master: 24 box



Cod. **PMOTO0031000**

Trasparente - Transparent
Pack 10 pcs
Packaging:
Elegant box
Master: 24 box

Coperchi - Lids



Cod. **PMOTO001/C**

Ø 42 mm
Trasparente - Transparent
Pack 100 pcs
per PMOTO001



Cod. **PMOTO002/C**

Ø 50 mm
Trasparente - Transparent
Pack 100 pcs
per PMOTO002



Cod. **PMOTO003/C**

Ø 55 mm
Trasparente - Transparent
Pack 100 pcs
per PMOTO003

CLASSIC COLOURFUL

Ø60 h90 mm

Cap. **170** ml



Cod. **PMOTO004**
Trasparente - Transparent
Pack 100 pcs
Packaging:
sacchetto trasparente
transparent bag

Cod. **PMOTO004/24**
Trasparente - Transparent
Pack 24 pcs
Packaging:
sacchetto trasparente
transparent bag



Cod. **PMOTO0041200**
Trasparente - Transparent
Pack 12 pcs
Packaging:
Elegant box
Master: 12 box



Cod. **PMOTO004/C**
Ø 60 mm
Trasparente - Transparent
Pack 100 pcs
per PMOTO004

Ø42 h65 mm

Cap. **65** ml



Cod. **PMOTO001.05**
Marrone - Brown
Pack 100 pcs
Packaging:
sacchetto trasparente
transparent bag



Cod. **PMOTO001.09**
Verde - Green
Pack 100 pcs
Packaging:
sacchetto trasparente
transparent bag



Cod. **PMOTO001.10**
Lilla - Lilac
Pack 100 pcs
Packaging:
sacchetto trasparente
transparent bag



Cod. **PMOTO001.21**
Fucsia - Fuchsia
Pack 100 pcs
Packaging:
sacchetto trasparente
transparent bag

CLASSIC

40x40 h55 mm

Cap. **60 ml**



Cod. **PMOCU001**

Trasparente - Transparent
Pack 100 pcs
Packaging:
sacchetto trasparente
transparent bag

Cod. **PMOCU001/24**

Trasparente - Transparent
Pack 24 pcs
Packaging:
sacchetto trasparente
transparent bag



Cod. **PMOCU0012800**

Trasparente - Transparent
Pack 28 pcs
Packaging:
Elegant box
Master: 24 box

Coperchi - Lids



Cod. **PMOCU001/C**

40x40 mm
Trasparente - Transparent
Pack 100 pcs
per PMOCU001

50x50 h70 mm

Cap. **120 ml**



Cod. **PMOCU002**

Trasparente - Transparent
Pack 100 pcs
Packaging:
sacchetto trasparente
transparent bag

Cod. **PMOCU002/24**

Trasparente - Transparent
Pack 24 pcs
Packaging:
sacchetto trasparente
transparent bag



Cod. **PMOCU0021200**

Trasparente - Transparent
Pack 12 pcs
Packaging:
Elegant box
Master: 24 box



Cod. **PMOCU002/C**

50x50 mm
Trasparente - Transparent
Pack 100 pcs
per PMOCU002

55x55 h80 mm

Cap. **175 ml**



Cod. **PMOCU003**

Trasparente - Transparent
Pack 100 pcs
Packaging:
sacchetto trasparente
transparent bag

Cod. **PMOCU003/24**

Trasparente - Transparent
Pack 24 pcs
Packaging:
sacchetto trasparente
transparent bag



Cod. **PMOCU0031000**

Trasparente - Transparent
Pack 10 pcs
Packaging:
Elegant box
Master: 24 box



Cod. **PMOCU003/C**

55x55 mm
Trasparente - Transparent
Pack 100 pcs
per PMOCU003

CLASSIC COLOURFUL

40x40 h55 mm

Cap. **60** ml



Cod. **PMOCU001.05**

Marrone - Brown

Pack 100 pcs

Packaging:
sacchetto trasparente
transparent bag



Cod. **PMOCU001.09**

Verde - Green

Pack 100 pcs

Packaging:
sacchetto trasparente
transparent bag



Cod. **PMOCU001.10**

Lilla - Lilac

Pack 100 pcs

Packaging:
sacchetto trasparente
transparent bag



Cod. **PMOCU001.21**

Fucsia - Fuchsia

Pack 100 pcs

Packaging:
sacchetto trasparente
transparent bag



Ø85 h65 mm

Cap. **175 ml**



Cod. **PM007/C**
Trasparente - Transparent
Pack 100 pcs
per PM007



Cod. **PM007.00**
Trasparente - Transparent
Pack 100 pcs
Packaging:
transparent pack



Cod. **PM007.01**
Bianco - White
Pack 100 pcs
Packaging:
transparent pack



Cod. **PM007.02**
Nero - Black
Pack 100 pcs
Packaging:
transparent pack

Cod. **PM007.00/25**
Trasparente - Transparent
Pack 25 pcs
Packaging:
transparent pack

Cod. **PM007.01/25**
Bianco - White
Pack 25 pcs
Packaging:
transparent pack

Cod. **PM007.02/25**
Nero - Black
Pack 25 pcs
Packaging:
transparent pack



Cod. **PM0071800**
Trasparente - Transparent
Pack 18 pcs
Packaging:
Elegant box
Master: 24 box

Ø40 h85 mm

Cap. **80 ml**



Cod. **PM008.00**
Trasparente - Transparent
Pack 100 pcs
Packaging:
transparent pack



Cod. **PM008.01**
Bianco - White
Pack 100 pcs
Packaging:
transparent pack



Cod. **PM008.02**
Nero - Black
Pack 100 pcs
Packaging:
transparent pack

Cod. **PM008.00/25**
Trasparente - Transparent
Pack 25 pcs
Packaging:
transparent pack

Cod. **PM008.01/25**
Bianco - White
Pack 25 pcs
Packaging:
transparent pack

Cod. **PM008.02/25**
Nero - Black
Pack 25 pcs
Packaging:
transparent pack



Cod. **PM008.05**
Marrone - Brown
Pack 100 pcs
Packaging:
transparent pack



Cod. **PM008.09**
Verde - Green
Pack 100 pcs
Packaging:
transparent pack



Cod. **PM008.10**
Lilla - Lilac
Pack 100 pcs
Packaging:
transparent pack



Cod. **PM008.21**
Fucsia - Fuchsia
Pack 100 pcs
Packaging:
transparent pack



Cod. **PM0081800**
Trasparente - Transparent
Pack 18 pcs
Packaging:
Elegant box
Master: 12 box

Ø67,5x h58 mm
Cap. **120 ml**



Cod. **PMOVA001.00**
Pack 100 pcs
Packaging:
sacchetto trasparente
transparent bag

Ø72x h51 mm
Cap. **120 ml**



Cod. **PMOVA002.00**
Pack 100 pcs
Packaging:
sacchetto trasparente
transparent bag

Ø75,5x h35 mm
Cap. **120 ml**



Cod. **PMOVA003.00**
Pack 100 pcs
Packaging:
sacchetto trasparente
transparent bag



Cod. **PMOVA001**
Pack 100 pcs
Packaging:
sacchetto trasparente
transparent bag



Cod. **PMOVA002**
Pack 100 pcs
Packaging:
sacchetto trasparente
transparent bag



Cod. **PMOVA003**
Pack 100 pcs
Packaging:
sacchetto trasparente
transparent bag



Ø65x h36 mm
Cap. **70 ml**

Pack 100 pcs
Packaging:
sacchetto trasparente
transparent bag

Cod. **60P00100**
Trasparente - Transparent

Cod. **60P00111**
Giallo - Yellow

Cod. **60P00109**
Verde - Green

Cod. **60P00102**
Azzurro - Sky blue

Cod. **60P00107**
Rosa - Pink

Cod. **60P00121**
Fucsia - Fuchsia

Cod. **60P00108**
Rosso - Red



Pack 12 pcs
Packaging:
Elegant box

Cod. **60P00100/12**
Trasparente - Transparent

Cod. **60P00111/12**
Giallo - Yellow

Cod. **60P00109/12**
Verde - Green

Cod. **60P00102/12**
Azzurro - Sky blue

Cod. **60P00107/12**
Rosa - Pink

Cod. **60P00121/12**
Fucsia - Fuchsia

Cod. **60P00108/12**
Rosso - Red



Ø76x h43 mm
Cap. **120 ml**

Pack 100 pcs
Packaging:
sacchetto trasparente
transparent bag

Cod. **60P00200**
Trasparente - Transparent

Cod. **60P00211**
Giallo - Yellow

Cod. **60P00209**
Verde - Green

Cod. **60P00202**
Azzurro - Sky blue

Cod. **60P00207**
Rosa - Pink

Cod. **60P00221**
Fucsia - Fuchsia

Cod. **60P00208**
Rosso - Red



Pack 12 pcs
Packaging:
Elegant box

Cod. **60P00200/12**
Trasparente - Transparent

Cod. **60P00211/12**
Giallo - Yellow

Cod. **60P00209/12**
Verde - Green

Cod. **60P00202/12**
Azzurro - Sky blue

Cod. **60P00207/12**
Rosa - Pink

Cod. **60P00221/12**
Fucsia - Fuchsia

Cod. **60P00208/12**
Rosso - Red

Ø65 h55 mm

Cap. **90 ml**

Cod. **PMOCO001**

Trasparente - Transparent

Pack 100 pcs

Packaging:

Scatola Avana - Cardboard box



Cod. **PMOCO0013000**

Trasparente - Transparent

Pack 30 pcs

Packaging:

Scatola bianca - White Cardboard box



Cod. **PMOCO001/C**

Ø 65 mm

Trasparente - Transparent

Pack 100 pcs

per PMOCO001



Ø70 h67 mm

Cap. **135 ml**

Cod. **PMOCO002**

Trasparente - Transparent

Pack 100 pcs

Packaging:

Scatola Avana - Cardboard box



Cod. **PMOCO0022500**

Trasparente - Transparent

Pack 25 pcs

Packaging:

Scatola bianca - White Cardboard box



Cod. **PMOCO002/C**

Ø 70 mm

Trasparente - Transparent

Pack 100 pcs

per PMOCO002



Ø75 h73 mm

Cap. **150 ml**

Cod. **PMOCO003**

Trasparente - Transparent

Pack 100 pcs

Packaging:

Scatola Avana - Cardboard box



Cod. **PMOCO0032000**

Trasparente - Transparent

Pack 20 pcs

Packaging:

Scatola bianca - White Cardboard box



Cod. **PMOCO003/C**

Ø 75 mm

Trasparente - Transparent

Pack 100 pcs

per PMOCO003



Ø90 h75 mm

Cap. **215 ml**

Cod. **PMOCO004**

Trasparente - Transparent

Pack 100 pcs

Packaging:

Scatola Avana - Cardboard box



Cod. **PMOCO0042500**

Trasparente - Transparent

Pack 25 pcs

Packaging:

Scatola bianca - White Cardboard box



Ø90 h75 mm

Cap. **165 ml**

Cod. **PMOCO005**

Trasparente - Transparent

Pack 100 pcs

Packaging:

Scatola Avana - Cardboard box



Cod. **PMOCO0052000**

Trasparente - Transparent

Pack 20 pcs

Packaging:

Scatola bianca - White Cardboard box



Ø75 h85 mm

Cap. **190 ml**

Cod. **PMOCO006**

Trasparente - Transparent

Pack 100 pcs

Packaging:

Scatola Avana - Cardboard box



Cod. **PMOCO0062000**

Trasparente - Transparent

Pack 20 pcs

Packaging:

Scatola bianca - White Cardboard box



Ø75 h85 mm

Cap. **190 ml**

Cod. **PMOCO007**

Trasparente - Transparent

Pack 100 pcs

Packaging:

Scatola Avana - Cardboard box



Cod. **PMOCO0072000**

Trasparente - Transparent

Pack 20 pcs

Packaging:

Scatola bianca - White Cardboard box



PLASTIC PACKAGING

Elegante confezione in plastica composta da vassoio e coperchio.
Gli alveoli possono contenere bicchierini tondi e quadri.

Imballo adatto ai seguenti modelli:

PMOTO001 - PMOCU001

Elegant plastic package made up of one tray and one cover.
The alveoli can contain round and square glasses.

Package for the following models:

PMOTO001 - PMOCU001



Cod. **BCM002**

Misura/Size:
140x72 h 72mm
Cap.: 2 pcs
Conf.: 25 pcs



Cod. **BCM004**

Misura/Size:
260x75 h 72mm
Cap.: 4 pcs
Conf.: 25 pcs



Cod. **BCM006**

Misura/Size:
200x134 h 72mm
Cap.: 6 pcs
Conf.: 25 pcs



Cod. **BCM012**

Misura/Size:
250x190 h 72mm
Cap.: 12 pcs
Conf.: 25 pcs

Elegante confezione in plastica con vassoio alveolare.
Gli alveoli possono contenere bicchierini tondi e quadri.
Imballo adatto ai seguenti modelli:
PMOTO001 - PMOCU001
Elegant plastic package with alveolar tray.
The alveoli can contain round and square glasses.
Package for the following models:
PMOTO001 - PMOCU001

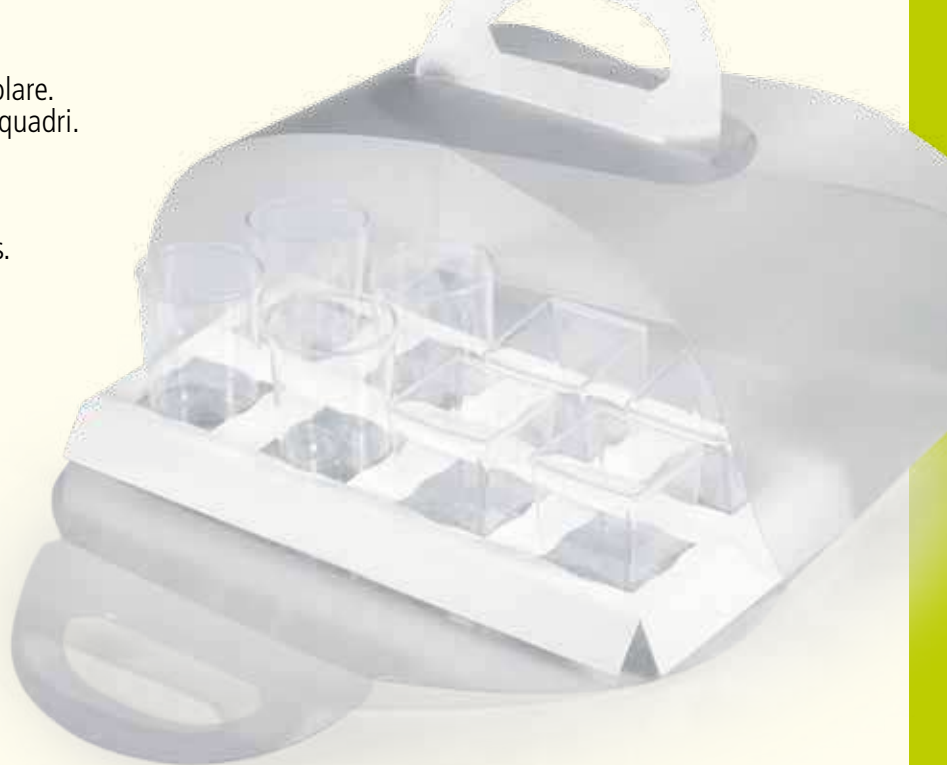

Vassoi in cartone inclusi.
Cardboard trays included.

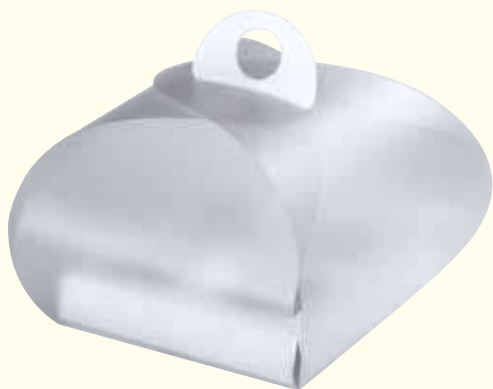

Cod. **BCM100**
Misura/Size:
150x150 h 120mm
Cap.: 4 pcs
Conf.: 25 pcs

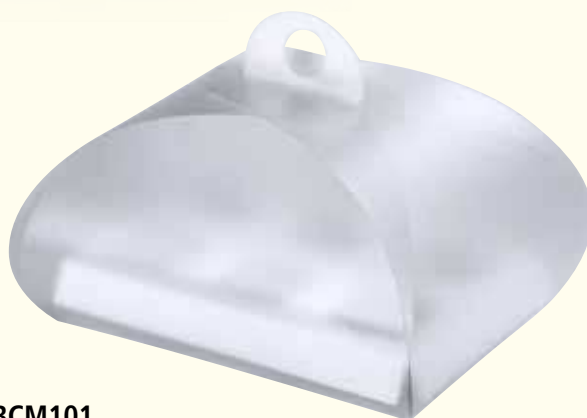

Cod. **BCM101**
Misura/Size:
150x200 h 140mm
Cap.: 6 pcs
Conf.: 25 pcs



Cod. **BCM102**
Misura/Size:
150x250 h 160mm
Cap.: 8 pcs
Conf.: 25 pcs



Cod. **BCM103**
Misura/Size:
210x250 h 160mm
Cap.: 12 pcs
Conf.: 25 pcs

CARDBOARD PACKAGING

Supporti per bicchierini in cartoncino color nero. La striscia può essere suddivisa lungo il tratteggio in base all'esigenza.
 Support for disposable glasses made of black paperboard.
 The stripe can be divided along the cross-hatching according to customer's needs.



ESEMPIO DI SUP003 - 100 barre da 6 unità ogni unità si può separare
 EXAMPLE OF SUP003 - 100 paper bars made up of 6 detachable units

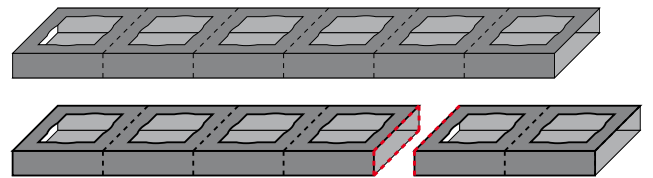

cod. SUP001	100 pcs	800 unità - units	suitable for:	PMOCU001 - PMOTO001
cod. SUP003	100 pcs	600 unità - units	suitable for:	PMOCU002 - PMOTO003
cod. SUP004	100 pcs	600 unità - units	suitable for:	PMOCU003 - PMOTO004

I bauletti Martellato, realizzati in robusto cartoncino alimentare, possono contenere 4-6 bicchierini o coppette di diverse dimensioni e formati.
 Martellato little trunks are made of resistant food-safe cardboard and can contain 4-6 glasses or cups of different sizes and shapes.



cod. 61-0003	Bauletto e vassoio grande per 4 bicchierini Big trunk and 4 glasses big tray	225x225 h 118	25 pcs	suitable for:	PMOCO002-3-4-5-6-7 / PMOCU003 / PMO07
cod. 61-0004	Bauletto e vassoio grande per 6 bicchierini Big trunk and 6 glasses big tray	325x225 h 118	25 pcs	suitable for:	PMOCO002-3-4-5-6-7 / PMOCU003 / PMO07

MINI PLATES

Eleganti piattini in plastica trasparente ideali per monoporzioni, o per realizzare piccole confezioni.
Small and elegant dessert mini plates made of transparent plastic for single-serving food or small packages.

Cod. **PM01**
87x87 h6 mm
Pack 100 pcs



Cod. **PM02**
Ø100 h6 mm
Pack 100 pcs



Cod. **PM04**
110x75 h6 mm
Pack 100 pcs



Cod. **PM05**
110x105 h6 mm
Pack 100 pcs



Cod. **PM06**
120x100 h6 mm
Pack 100 pcs



DISPOSABLE FLÛTE

Bicchieri in plastica trasparente
con base predisposta per incastro a piramide.
Transparent plastic flûte with base arranged for pyramid joint.

Cod. **FLU01**
Ø56x h170 mm
Cap. 120 ml
Pack 100 pcs



MINI PLATES



90x90 h15 mm

Cap. **20 ml**



Cod. **PMO09.00**
Trasparente - Transparent
Pack 100 pcs
Packaging: transparent pack



Cod. **PMO09.01**
Bianco - White
Pack 100 pcs
Packaging: transparent pack



Cod. **PMO09.02**
Nero - Black
Pack 100 pcs
Packaging: transparent pack





Cod. **PMO09.00/25**
Trasparente - Transparent
Pack 25 pcs
Packaging: transparent pack

Cod. **PMO09.01/25**
Bianco - White
Pack 25 pcs
Packaging: transparent pack

Cod. **PMO09.02/25**
Nero - Black
Pack 25 pcs
Packaging: transparent pack



 Cod. **PMO09.05**
Marrone - Brown
Pack 100 pcs
Packaging: transparent pack

 Cod. **PMO09.09**
Verde - Green
Pack 100 pcs
Packaging: transparent pack

 Cod. **PMO09.10**
Lilla - Lilac
Pack 100 pcs
Packaging: transparent pack

 Cod. **PMO09.21**
Fucsia - Fuchsia
Pack 100 pcs
Packaging: transparent pack

Cod. **PMO092000**
Trasparente - Transparent
Pack 20 pcs
Packaging:
Elegant box
Master: 12 box

85x85 h30 mm

Cap. **30 ml**



Cod. **PMO10.00**
Trasparente - Transparent
Pack 100 pcs
Packaging: transparent pack



Cod. **PMO10.01**
Bianco - White
Pack 100 pcs
Packaging: transparent pack



Cod. **PMO10.02**
Nero - Black
Pack 100 pcs
Packaging: transparent pack





Cod. **PMO10.00/25**
Trasparente - Transparent
Pack 25 pcs
Packaging: transparent pack

Cod. **PMO10.01/25**
Bianco - White
Pack 25 pcs
Packaging: transparent pack

Cod. **PMO10.02/25**
Nero - Black
Pack 25 pcs
Packaging: transparent pack



 Cod. **PMO10.05**
Marrone - Brown
Pack 100 pcs
Packaging: transparent pack

 Cod. **PMO10.09**
Verde - Green
Pack 100 pcs
Packaging: transparent pack

 Cod. **PMO10.10**
Lilla - Lilac
Pack 100 pcs
Packaging: transparent pack

 Cod. **PMO10.21**
Fucsia - Fuchsia
Pack 100 pcs
Packaging: transparent pack

Cod. **PMO101000**
Trasparente - Transparent
Pack 10 pcs
Packaging:
Elegant box
Master: 12 box

75x75 h30 mm

Cap. **50 ml**



Cod. **PMO11.00**
Trasparente - Transparent
Pack 100 pcs
Packaging: transparent pack



Cod. **PMO11.01**
Bianco - White
Pack 100 pcs
Packaging: transparent pack



Cod. **PMO11.02**
Nero - Black
Pack 100 pcs
Packaging: transparent pack



Cod. **PMO11.00/25**
Trasparente - Transparent
Pack 25 pcs
Packaging: transparent pack

Cod. **PMO11.01/25**
Bianco - White
Pack 25 pcs
Packaging: transparent pack

Cod. **PMO11.02/25**
Nero - Black
Pack 25 pcs
Packaging: transparent pack



Cod. **PMO11.05**
Marrone - Brown
Pack 100 pcs
Packaging: transparent pack



Cod. **PMO11.09**
Verde - Green
Pack 100 pcs
Packaging: transparent pack



Cod. **PMO11.10**
Lilla - Lilac
Pack 100 pcs
Packaging: transparent pack



Cod. **PMO11.21**
Fucsia - Fuchsia
Pack 100 pcs
Packaging: transparent pack

Cod. **PMO111500**
Trasparente - Transparent
Pack 15 pcs
Packaging:
Elegant box
Master: 24 box

105x50 h30 mm

Cap. **11 ml**



Cod. **PMO12.00**
Trasparente - Transparent
Pack 100 pcs
Packaging: transparent pack



Cod. **PMO12.01**
Bianco - White
Pack 100 pcs
Packaging: transparent pack



Cod. **PMO12.02**
Nero - Black
Pack 100 pcs
Packaging: transparent pack

Cod. **PMO12.00/25**
Trasparente - Transparent
Pack 25 pcs
Packaging: transparent pack

Cod. **PMO12.01/25**
Bianco - White
Pack 25 pcs
Packaging: transparent pack

Cod. **PMO12.02/25**
Nero - Black
Pack 25 pcs
Packaging: transparent pack



Cod. **PMO12.05**
Marrone - Brown
Pack 100 pcs
Packaging: transparent pack



Cod. **PMO12.09**
Verde - Green
Pack 100 pcs
Packaging: transparent pack



Cod. **PMO12.10**
Lilla - Lilac
Pack 100 pcs
Packaging: transparent pack



Cod. **PMO12.21**
Fucsia - Fuchsia
Pack 100 pcs
Packaging: transparent pack



Cod. **PMO122000**
Trasparente - Transparent
Pack 20 pcs
Packaging:
Elegant box
Master: 12 box



65x65 h15 mm

Cap. **15 ml**



Cod. **PMO13.00**
Trasparente - Transparent
Pack 100 pcs
Packaging:
sacchetto trasparente
transparent bag



Cod. **PMO13.01**
Bianco - White
Pack 100 pcs
Packaging:
sacchetto trasparente
transparent bag



Cod. **PMO13.02**
Nero - Black
Pack 100 pcs
Packaging:
sacchetto trasparente
transparent bag

Cod. **PMO13.00/25**
Trasparente - Transparent
Pack 25 pcs
Packaging:
sacchetto trasparente
transparent bag

Cod. **PMO13.01/25**
Bianco - White
Pack 25 pcs
Packaging:
sacchetto trasparente
transparent bag

Cod. **PMO13.02/25**
Nero - Black
Pack 25 pcs
Packaging:
sacchetto trasparente
transparent bag



Cod. **PMO135000**
Trasparente - Transparent
Pack 50 pcs
Packaging:
Elegant box
Master: 12 box

110x65 h20 mm

Cap. **20 ml**



Cod. **PMO14.00**
Trasparente - Transparent
Pack 100 pcs
Packaging:
sacchetto trasparente
transparent bag



Cod. **PMO14.01**
Bianco - White
Pack 100 pcs
Packaging:
sacchetto trasparente
transparent bag



Cod. **PMO14.02**
Nero - Black
Pack 100 pcs
Packaging:
sacchetto trasparente
transparent bag

Cod. **PMO14.00/25**
Trasparente - Transparent
Pack 25 pcs
Packaging:
sacchetto trasparente
transparent bag

Cod. **PMO14.01/25**
Bianco - White
Pack 25 pcs
Packaging:
sacchetto trasparente
transparent bag

Cod. **PMO14.02/25**
Nero - Black
Pack 25 pcs
Packaging:
sacchetto trasparente
transparent bag



Cod. **PMO142000**
Trasparente - Transparent
Pack 20 pcs
Packaging:
Elegant box
Master: 12 box

115x105 h15 mm

Cap. **30 ml**



Cod. **PM015.00**
Trasparente - Transparent
Pack 100 pcs
Packaging:
sacchetto trasparente
transparent bag



Cod. **PM015.01**
Bianco - White
Pack 100 pcs
Packaging:
sacchetto trasparente
transparent bag



Cod. **PM015.02**
Nero - Black
Pack 100 pcs
Packaging:
sacchetto trasparente
transparent bag

Cod. **PM015.00/25**
Trasparente - Transparent
Pack 25 pcs
Packaging:
sacchetto trasparente
transparent bag

Cod. **PM015.01/25**
Bianco - White
Pack 25 pcs
Packaging:
sacchetto trasparente
transparent bag

Cod. **PM015.02/25**
Nero - Black
Pack 25 pcs
Packaging:
sacchetto trasparente
transparent bag



Cod. **PM0152500**
Trasparente - Transparent
Pack 25 pcs
Packaging:
Elegant box
Master: 12 box

MINI SKEWER

90 mm

Cod. **FW003**
Trasparente - Transparent
Pack 500 pcs
Packaging:
sacchetto trasparente
transparent bag

Cod. **FW003/250**
Trasparente - Transparent
Pack 250 pcs
Packaging:
sacchetto trasparente
transparent bag



Cod. **FW0031000**
Trasparente - Transparent
Pack 100 pcs
Packaging:
Elegant box
Master: 12 box

120 mm

Cod. **FW004**
Trasparente - Transparent
Pack 500 pcs
Packaging:
sacchetto trasparente
transparent bag

Cod. **FW004/250**
Trasparente - Transparent
Pack 250 pcs
Packaging:
sacchetto trasparente
transparent bag



Cod. **FW0041000**
Trasparente - Transparent
Pack 100 pcs
Packaging:
Elegant box
Master: 12 box

MINI FLATWARE

85mm



Cod. **FW001.00**
Trasparente - Transparent
Pack 500 pcs
Packaging:
sacchetto trasparente
transparent bag



Cod. **FW001.01**
Bianco - White
Pack 500 pcs
Packaging:
sacchetto trasparente
transparent bag



Cod. **FW001.02**
Nero - Black
Pack 500 pcs
Packaging:
sacchetto trasparente
transparent bag

Cod. **FW001.00/100**
Trasparente - Transparent
Pack 100 pcs
Packaging:
sacchetto trasparente
transparent bag

Cod. **FW001.01/100**
Bianco - White
Pack 100 pcs
Packaging:
sacchetto trasparente
transparent bag

Cod. **FW001.02/100**
Nero - Black
Pack 100 pcs
Packaging:
sacchetto trasparente
transparent bag



Cod. **FW0011000**
Trasparente - Transparent
Pack 100 pcs
Packaging:
Elegant box
Master: 12 box

85mm



Cod. **FW002.00**
Trasparente - Transparent
Pack 500 pcs
Packaging:
sacchetto trasparente
transparent bag



Cod. **FW002.01**
Bianco - White
Pack 500 pcs
Packaging:
sacchetto trasparente
transparent bag



Cod. **FW002.02**
Nero - Black
Pack 500 pcs
Packaging:
sacchetto trasparente
transparent bag

Cod. **FW002.00/100**
Trasparente - Transparent
Pack 100 pcs
Packaging:
sacchetto trasparente
transparent bag

Cod. **FW002.01/100**
Bianco - White
Pack 100 pcs
Packaging:
sacchetto trasparente
transparent bag

Cod. **FW002.02/100**
Nero - Black
Pack 100 pcs
Packaging:
sacchetto trasparente
transparent bag



Cod. **FW0021000**
Trasparente - Transparent
Pack 100 pcs
Packaging:
Elegant box
Master: 12 box

75mm



Cod. **FW005.00**
Trasparente - Transparent
Pack 250 pcs
Packaging:
sacchetto trasparente
transparent bag



Cod. **FW005.01**
Bianco - White
Pack 250 pcs
Packaging:
sacchetto trasparente
transparent bag



Cod. **FW005.02**
Nero - Black
Pack 250 pcs
Packaging:
sacchetto trasparente
transparent bag

Cod. **FW005.00/50**
Trasparente - Transparent
Pack 50 pcs
Packaging:
sacchetto trasparente
transparent bag

Cod. **FW005.01/50**
Bianco - White
Pack 50 pcs
Packaging:
sacchetto trasparente
transparent bag

Cod. **FW005.02/50**
Nero - Black
Pack 50 pcs
Packaging:
sacchetto trasparente
transparent bag



Cod. **FW0052400**
Trasparente - Transparent
Pack 24 pcs
Packaging:
Elegant box
Master: 12 box

75mm



Cod. **FW006.00**
Trasparente - Transparent
Pack 250 pcs
Packaging:
sacchetto trasparente
transparent bag



Cod. **FW006.01**
Bianco - White
Pack 250 pcs
Packaging:
sacchetto trasparente
transparent bag



Cod. **FW006.02**
Nero - Black
Pack 250 pcs
Packaging:
sacchetto trasparente
transparent bag

Cod. **FW006.00/50**
Trasparente - Transparent
Pack 50 pcs
Packaging:
sacchetto trasparente
transparent bag

Cod. **FW006.01/50**
Bianco - White
Pack 50 pcs
Packaging:
sacchetto trasparente
transparent bag

Cod. **FW006.02/50**
Nero - Black
Pack 50 pcs
Packaging:
sacchetto trasparente
transparent bag



Cod. **FW0062400**
Trasparente - Transparent
Pack 24 pcs
Packaging:
Elegant box
Master: 12 box

PROFESSIONAL CONTAINERS

Contenitori Isotermici Isothermal Containers

I contenitori isotermici grazie alla struttura del polipropilene espanso a cellula chiusa sono: idonei al contatto alimentare, resistenti, igienici, economici, e riciclabili al 100%, (HACCP System).

Non rilascia odori e non altera i sapori degli alimenti. Facilmente lavabile e sanificabile dopo il suo utilizzo.

Thanks to their closed cell expanded polypropylene structure, the isothermal containers are: resistant, hygienic, cheap, suitable for contact with food and 100% recyclable (HACCP System).

It does not hand over odours or flavours to foods and it is easy to wash and disinfect after use.

Base/Coperchio
Base/Cover

50x50

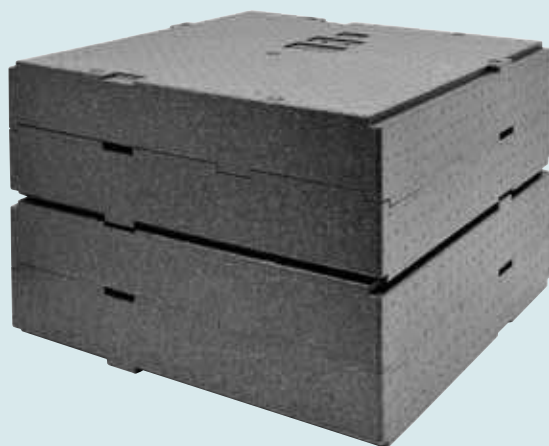
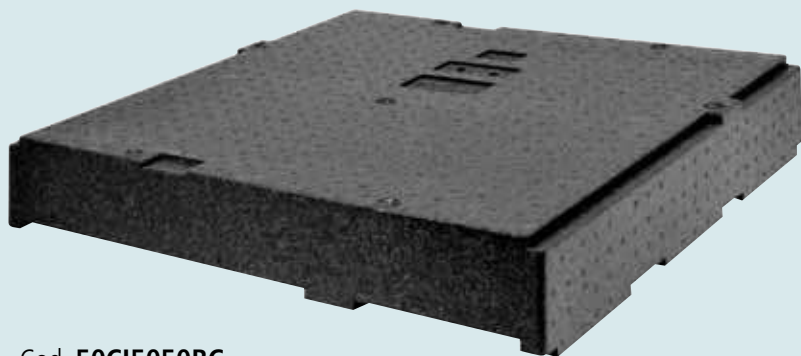

Cod. 50CI5050BC

Misure esterne - External size: 570x570x95 mm

Misure interne - Internal size: 510x510x63 mm

L'articolo 50CI5050BC, venduto singolarmente, può essere utilizzato sia come base che come coperchio del contenitore isoteramico.
The 50CI5050BC item is sold individually and can be used both as a base and as a cover for the isothermal container.

Estensore
Extender

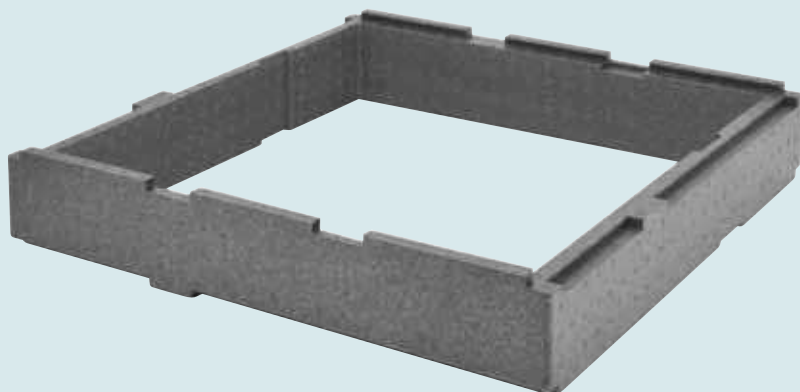

Cod. 50CI5050ES

Misure esterne - External size: 570x570x95 mm

Misure interne - Internal size: 510x510x95 mm

Ideale per - Ideal for:



Il contenitore isotermico
caricamento frontale.
Front loading isothermal box.

GASTRONORM



Cod. **50CI540GN**

Misure esterne - External size: 650x500x610 mm

Misure interne - Internal size: 540x330x480 mm

Cap. 83 Lt

Supporti salva guida non inclusi:

Wire rail brackets not included:

50CIA001

Accessori Accessories

Cod. **50CIA001**

Supporti salva guida per 50CI540GN

Wire rail bracket for 50CI540GN

Misure - Size 540x330 mm

kit 12pcs

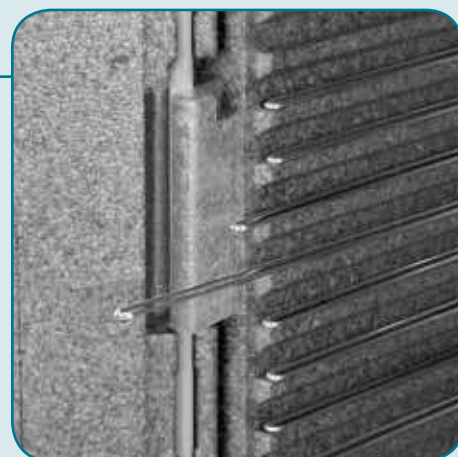
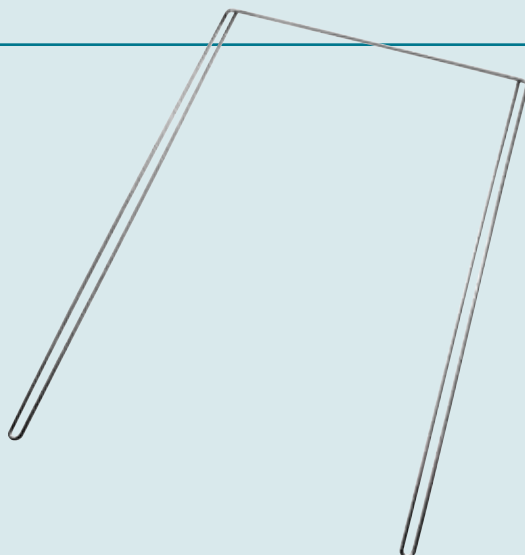

Il contenitore isotermico
caricamento frontale.
Front loading isothermal box.

60x40

9 guide



Cod. **50CI6040**

Misure esterne - External size: 720x600x630 mm

Misure interne - Internal size: 600x400x500 mm

Cap. 128,1 Lt

Supporti salva guida non inclusi:

Wire rail brackets not included:

50CIA002

Teglie 60x40 non incluse.
60x40 baking pans are not included.

Accessori Accessories

Cod. **50CIA002**

Supporti salva guida per 50CI6040

Wire rail bracket for 50CI6040

Misure - Size 600x400 mm

kit 9pcs

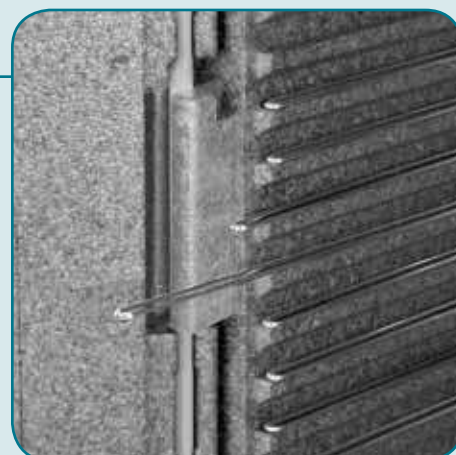
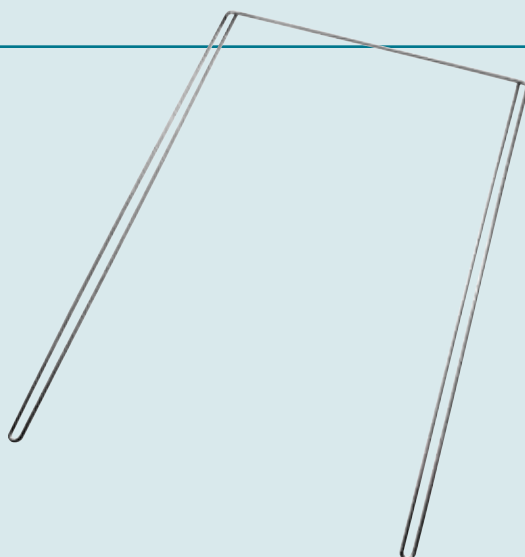



Cod. 50CI210GN

Misure esterne - External size: 600x400x270 mm
 Misure interne - Internal size: 540x340x210 mm
 Cap. 38,6 Lt

Cod. 50CI280GN

Misure esterne - External size: 600x400x340 mm
 Misure interne - Internal size: 540x340x280 mm
 Cap. 52,3 Lt

Ideale per vaschette gelato 330x165 mm
 Ideal for ice cream containers 330x165 mm



Accessori Accessories



Cod. 50CIA005

Piastra eutettica -21°C / 0°C
 Eutectic plate -21°C / 0°C
 Misure - size 530x525x30 mm



Cod. 50CIA004

Inserto per sistema Caldo&Freddo
 Misure esterne 605x405x110 mm

Hot&Cold System insert
 External size 605x405x110 mm



Cod. 50CIA003

Carrello plastica
 Plastic trolley
 Misure - size 610x410 mm

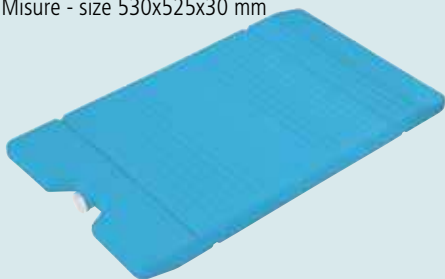

Cod. 50CIA008

Piastra eutettica -6°C / 0°C
 Eutectic plate -6°C / 0°C
 Misure - size 5cm
 Misure - size 380x215x30 mm



**Cod. 50CI086040**

Misure esterne - External size: 685x485x140 mm
 Misure interne - Internal size: 625x425x80 mm
 Cap. 21,3 Lt

Cod. 50CI166040

Misure esterne - External size: 685x485x240 mm
 Misure interne - Internal size: 625x425x160 mm
 Cap. 42,5 Lt

Cod. 50CI276040

Misure esterne - External size: 685x485x330 mm
 Misure interne - Internal size: 625x425x270 mm
 Cap. 71,7 Lt

Cod. 50CI126040

Misure esterne - External size: 685x485x180 mm
 Misure interne - Internal size: 625x425x120 mm
 Cap. 31,9 Lt

Cod. 50CI216040

Misure esterne - External size: 685x485x270 mm
 Misure interne - Internal size: 625x425x210 mm
 Cap. 55,8 Lt

Cod. 50CI316040

Misure esterne - External size: 685x485x370 mm
 Misure interne - Internal size: 625x425x310 mm
 Cap. 82,3 Lt

Accessori Accessories**Cod. 50CIA007**

Piastra eutettica -21°C / 0°C
 Eutectic plate -21°C / 0°C
 Misure - size 600x300x30 mm

**Cod. 50CIA006**

Inserto per sistema Caldo&Freddo
 Misure esterne 695x495x100 mm

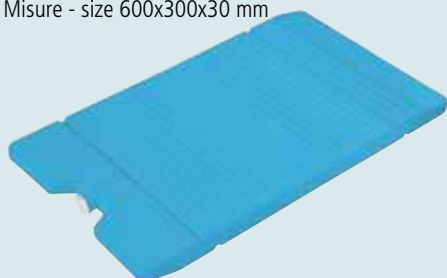
**Cod. 50CIA008**

Piastra eutettica -6°C / 0°C
 Eutectic plate -6°C / 0°C
 Misure - size 5cm
 Misure - size 380x215x30 mm





Cassa universale con coperchio per alimenti - trasparente
Food crate with lid - transparent

cod. **50CA382830** 38x28 h30 cm 20 Lt
 cod. **50CA583826** 58x38 h26 cm 40 Lt
 cod. **50CA583838** 58x38 h38 cm 60 Lt



Casse inseribili e sovrapponibili.
Insertables and stackable crates.



Cassa universale con coperchio per alimenti - bianco
Food crate with lid - white

cod. **50CA382830B** 38x28 h30 cm 20 Lt
 cod. **50CA583826B** 58x38 h26 cm 40 Lt
 cod. **50CA583838B** 58x38 h38 cm 60 Lt



Vassoi con bordo.
Tray with edge.

cod. **51VA200** 200x150 h 12 mm
 cod. **51VA280** 280x190 h 12 mm
 cod. **51VA350** 350x240 h 12 mm
 cod. **51VA420** 420x300 h 12 mm
 cod. **51VA500** 500x360 h 12 mm

Carrello per ceste - Plate basket trolley

In materiale plastico antiurto con ruote.
Made of strong plastic material with wheel.



Cod. **CAR 2**
45x60cm





Casse Milleusi inseribili e sovrapponibili.
Multipurpose insertables and stackable crates.

cod. **50CA5543C** 55x43 h 31 cm 50 Lt
cod. **50CA6344C** 63x44 h 34 cm 65 Lt
cod. **50CA7247C** 72x47 h 36 cm 90 Lt



Cassa fondo chiuso e pareti chiuse.
Full bottom and side crate.

cod. **50CA604007C** 60x40 h 7 cm 12 Lt
cod. **50CA604010C** 60x40 h 10 cm 18 Lt
cod. **50CA604013C** 60x40 h 13 cm 24 Lt



Casse Milleusi Forate inseribili e sovrapponibili.
Insertable and stackable perforated multipurpose crates.

cod. **50CA5543F** 55x43 h 31 cm 50 Lt
cod. **50CA6344F** 63x44 h 34 cm 65 Lt



Cassa fondo forato e pareti forate.
Perforated bottom and side crate.

cod. **50CA604007F** 60x40 h 7 cm 12 Lt
cod. **50CA604018F** 60x40 h 10 cm 18 Lt
cod. **50CA604024F** 60x40 h 13 cm 24 Lt



Coperchio per casse milleusi.
Multiproposer crate lids.

cod. **50CA50COP** 55x43 cm
cod. **50CA65COP** 63x44 cm
cod. **50CA90COP** 72x47 cm



Coperchio per casse 60x40.
Crate lid 60x40.

cod. **50CA6040COP** 60x40 cm

PLEXIGLASS DISPLAYS

La linea minimalista, moderna ed essenziale dei display Martellato si adatta perfettamente alle più diverse creazioni degli chefs.
The minimalist, modern and essential design of our plexiglass displays is perfectly suitable for all chefs' creations.

Swan

COD33806

Display plexiglass satinato
Glazed plexiglass display

con - with LED

Misura - Size: 41x73 - h 78 cm



COD33608

Display in plexiglass satinato e nero
Glazed and black plexiglass display

Misura - Size: 65x35 h 27 cm

Piatti - Plate:

37x26 cm

30x22 cm

22x16 cm

**COD33201**

Display in plexiglass trasparente
Transparent plexiglass display

Misura - Size: 38x53,3 h 71 cm

Piatti - Plate:

(2) 33x26 cm

(2) 29x22 cm

**COD33301**

Display in plexiglass trasparente
Transparent plexiglass display

Misura - Size: 34x34 h37,5 cm

Piatti - Plate: Ø34 - Ø26 - Ø15,5 cm

Distanza tra ripiani 11 cm

Distance between shelves 11 cm



COD33401

Display in plexiglass trasparente

Transparent plexiglass display

Misura - Size: 42x42 h 30,5 cm

Piatti - Plate: Ø42 - Ø37 - Ø25 cm

Distanza tra ripiani 12 cm



COD60501

Display in plexiglass trasparente

Transparent plexiglass display

Misura - Size: h41 cm

Piatti - Plate: 49x49 - 39x39 - 29x29 - 19x19 cm

Distanza tra ripiani 12 cm

Distance between shelves 12 cm

Stone

COD33501

Display in plexiglass satinato e bianco
Transparent and glaze plexiglass display

Misura - Size: h 50,5 cm

Piatti - Plate:

63,5 x 35 - 52,5 x 25,5 - 43 x 21,5 - 35 x 19 - 28 x 14,5 cm

Distanza tra ripiani 12 cm

Distance between shelves 12 cm



COD35101

Display in plexiglass trasparente
Transparent plexiglass display

Misura - Size: h 38 cm

Piatti - Plate:

50x50 h. 12 cm

36x36 h. 12 cm

22,5x22,5 h. 12 cm

COD33701

Display in plexiglass trasparente
Transparent plexiglass display
Piatti - Plate:
50x20 h20,5 - 50x20 h14 - 50x20 h7 cm



COD33906

Display in plexiglass satinato
Glazed plexiglass display
Piatti - Plate:
35,5x17 h22 cm
57x17 h9 cm
40x17 h5 cm

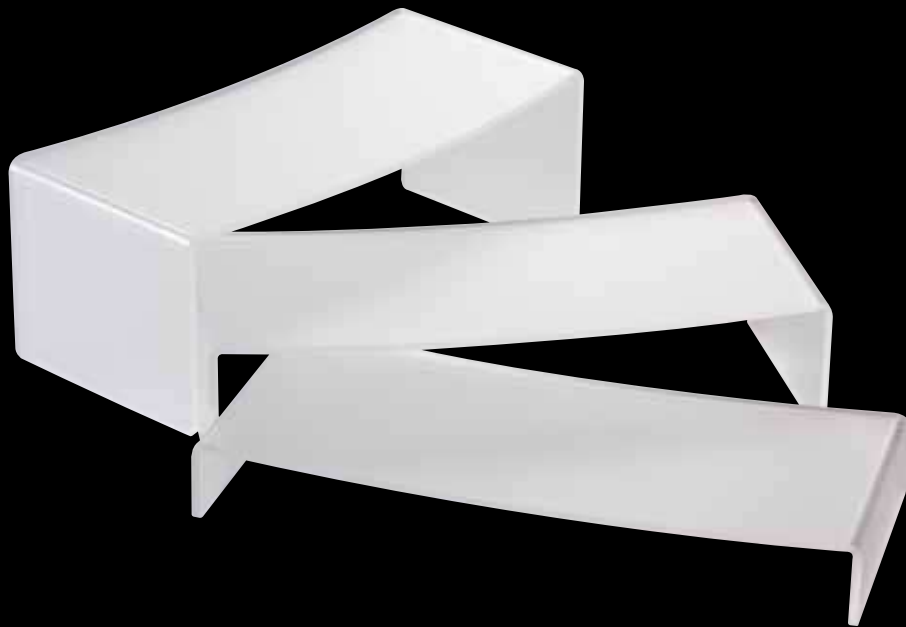

COD34001

Display in plexiglass trasparente
Transparent plexiglass display
Piatti - Plate:
49x15,5 h18 - 49x15,5 h13 - 49x15,5 h8 cm

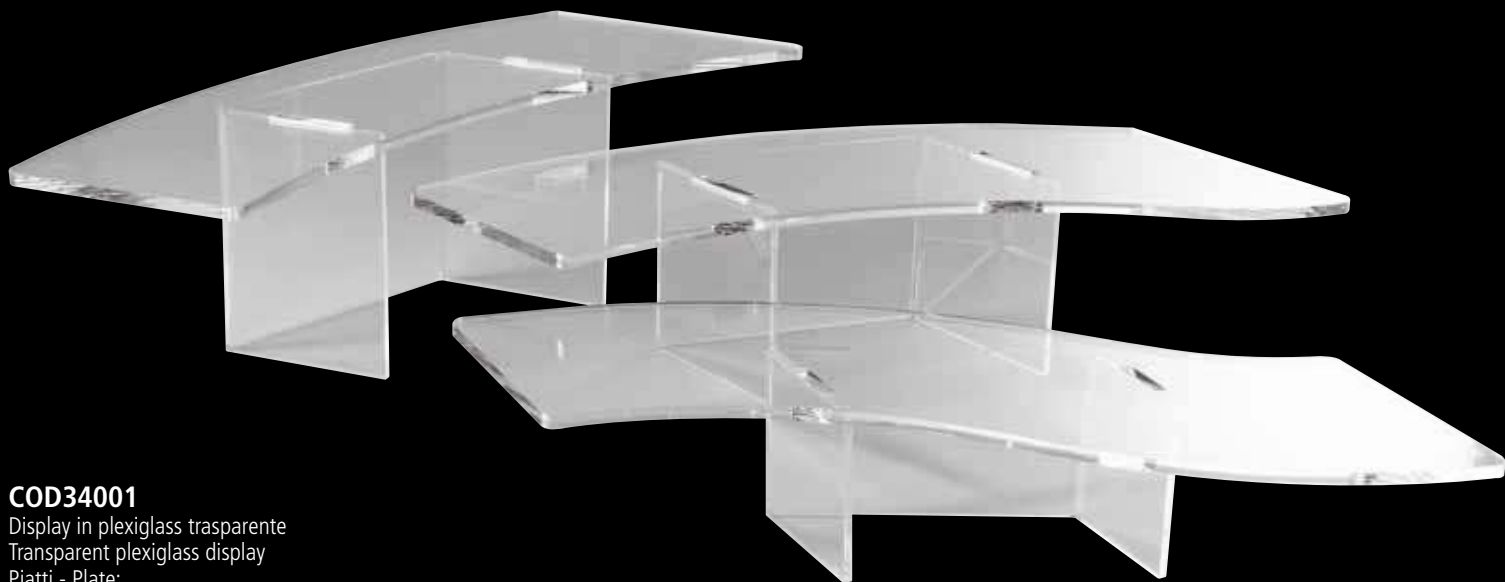





Cod. 32901

Misura - Size: 35x55,5 h27 cm
Piatti - Plate: 35x25 - 30x12 - 28x18 cm



Cod. 322

Misura - Size: h 49,5 cm
Piatti - Plate: Ø40,5 - 39 - 38 - 35,5 - 31,5 cm

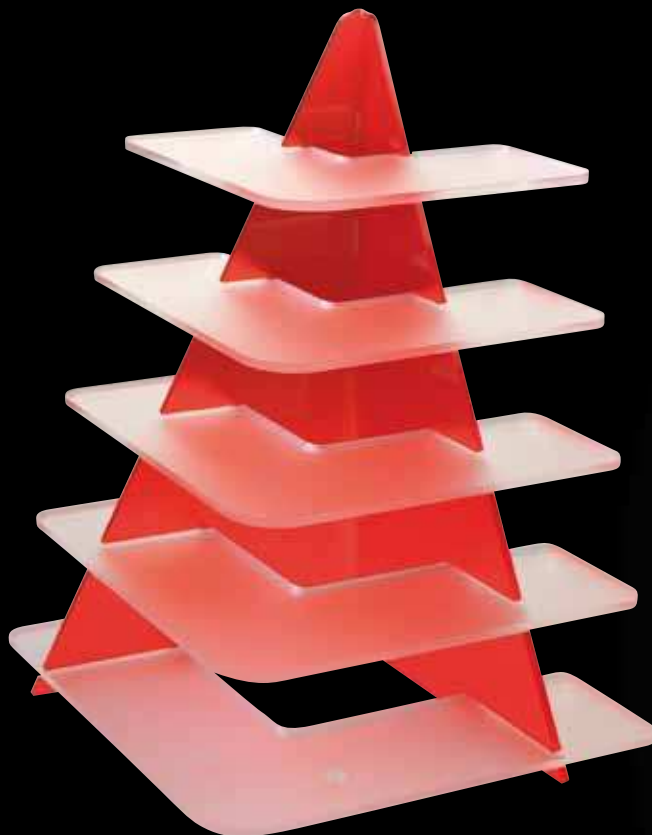

Cod. 321

Misura - Size: 56x35 - h 59 cm





Cod. **320**

Misura - Size: h 22,5 cm

Piatti - Plate: 65x35,5 cm



Cod. 316

Misura - Size: 33x33 - h 54,5 cm
 Piatti - Plate: 33x33 cm

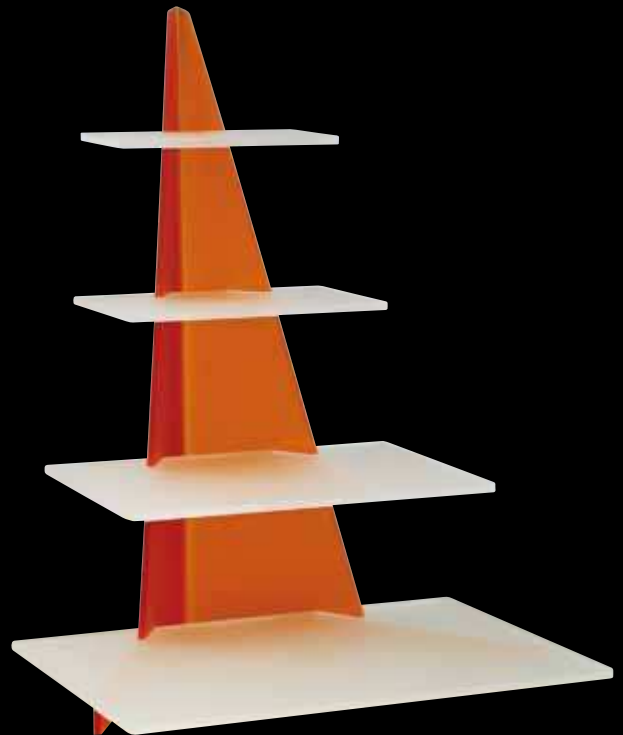

Cod. 300

Misura - Size: 54x47 - h 63 cm
 Piatti - Plate: 47x34 - 37x25 - 27x17 - 23x13 cm

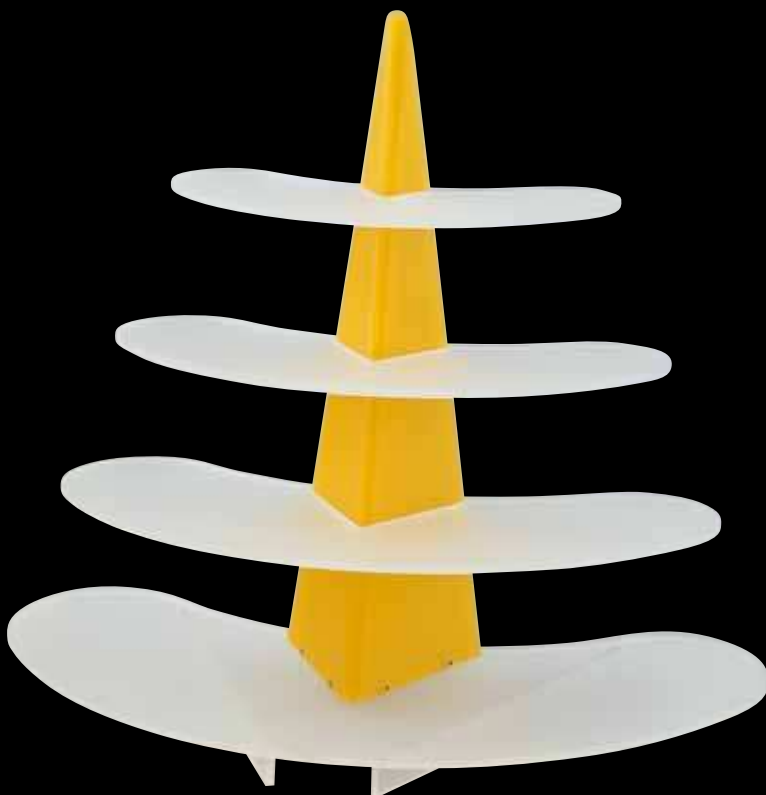

Cod. 301

Misura - Size: 70x40 - h 62 cm
 Piatti - Plate: 70x40 - 63x35 - 52x26 - 42x21 cm

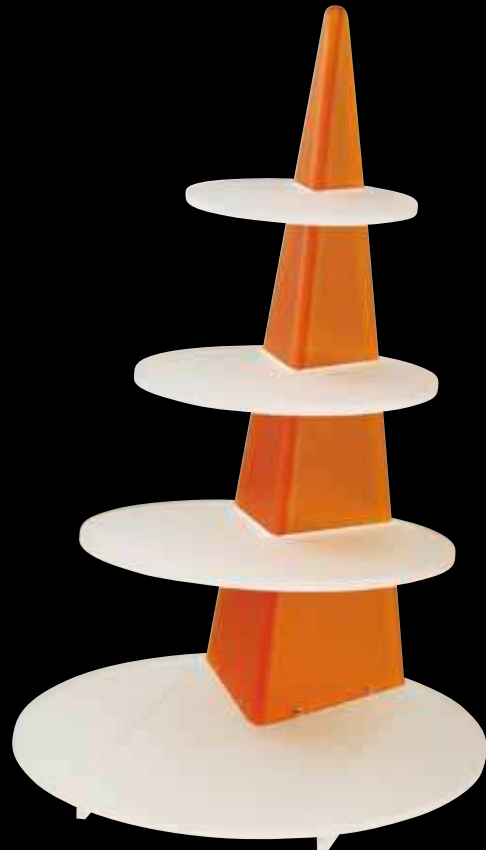

Cod. 302

Misura - Size: Ø 39 - h 62 cm
 Piatti - Plate: Ø 39 - Ø 31 - Ø 25 - Ø 19 cm



Cod. 303

Misura - Size: 60x50 - h 60 cm

Piatti - Plate: 60x43 - 49x35 - 27x37 - 25x18



Cod. 304

Misura - Size: Ø 56 - h 62 cm

Piatti - Plate: Ø 56 - Ø 46 - Ø 33 - Ø 22

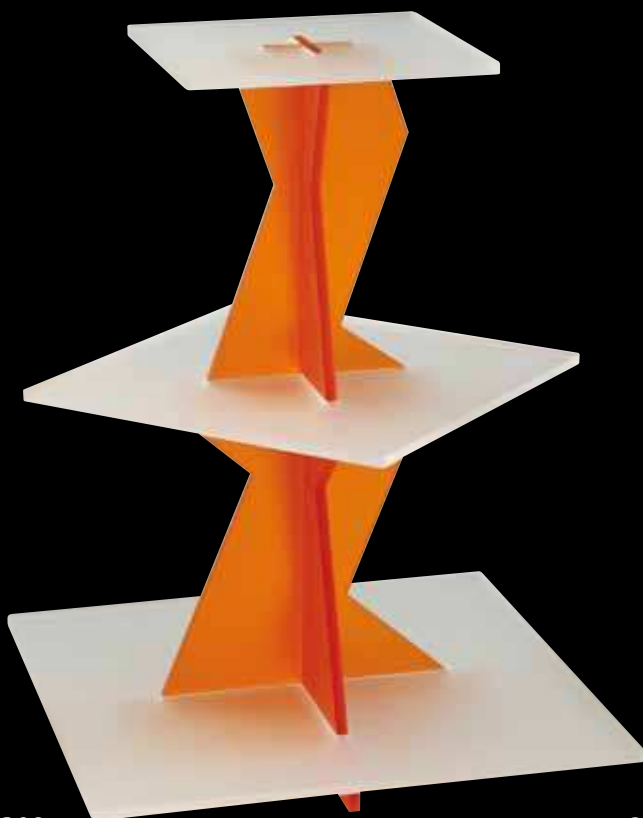

Cod. 308

Misura - Size: 40x40 - h 53 cm

Piatti - Plate: 40x40 - 30x30 - 22x22



Cod. 32816

Misura - Size: 53x46,5 h 57,5 cm

Piatti - Plate: Ø29 - Ø35 - Ø38 - Ø39 cm



Cod. **32602**

Misura - Size: 86x50 - h 50 cm

Piatti - Plate: Ø 50 - 50 - 24 Ø 50 - 50 - 24 cm



Cod. **32715**

Misura - Size: 52x43,5 - h 62 cm

Piatti - Plate: 34x18 - 43x23 - 46,5x25,5 - 42,5x23,5 cm



Cod. **32617**

Misura - Size: 86x50 - h 50 cm

Piatti - Plate: Ø 50 - 50 - 24 Ø 50 - 50 - 24 cm



Cod. **32717**

Misura - Size: 52x43,5 - h 62 cm

Piatti - Plate: 34x18 - 43x23 - 46,5x25,5 - 42,5x23,5 cm



Cod. 32416

Misura - Size: 45x30 h61 cm
Piatti - Plate: 32x24 (x3) cm



Cod. 309

Misura - Size: 25x25 cm - h 25 - 18 - 11 - 4 cm



Cod. 32418

Misura - Size: 45x30 h61 cm
Piatti - Plate: 32x24 (x3) cm



Cod. 33118 ROSA/PINK

Misura - Size: h 3,6 - 11 - 17,6 - 25 cm
Piatti - Plate: 24,5x24,5 cm

Cod. 33101 TRASPARENTE/TRANSPARENT

Misura - Size: h 3,6 - 11 - 17,6 - 25 cm
Piatti - Plate: 24,5x24,5 cm



Cod. **317**

Misura - Size: h 36 cm
Piatti - Plate: 29,7x21 cm



Cod. **318**

Misura - Size: h 36 cm
Piatti - Plate: 29,7x21 cm



Cod. **319**

Misura - Size: h 36 cm
Piatti - Plate: 29,7x21 cm



Cod. **323**

Misura - Size: h 36 cm
Piatti - Plate: 45x28 cm



Cod. **32508**

Misura - Size: 23x45 - h 74 cm
Piatti - Plate: Ø20 - Ø28 - Ø36 - Ø45 cm



Cod. **32518**

Misura - Size: 23x45 - h 74 cm
Piatti - Plate: Ø20 - Ø28 - Ø36 - Ø45 cm

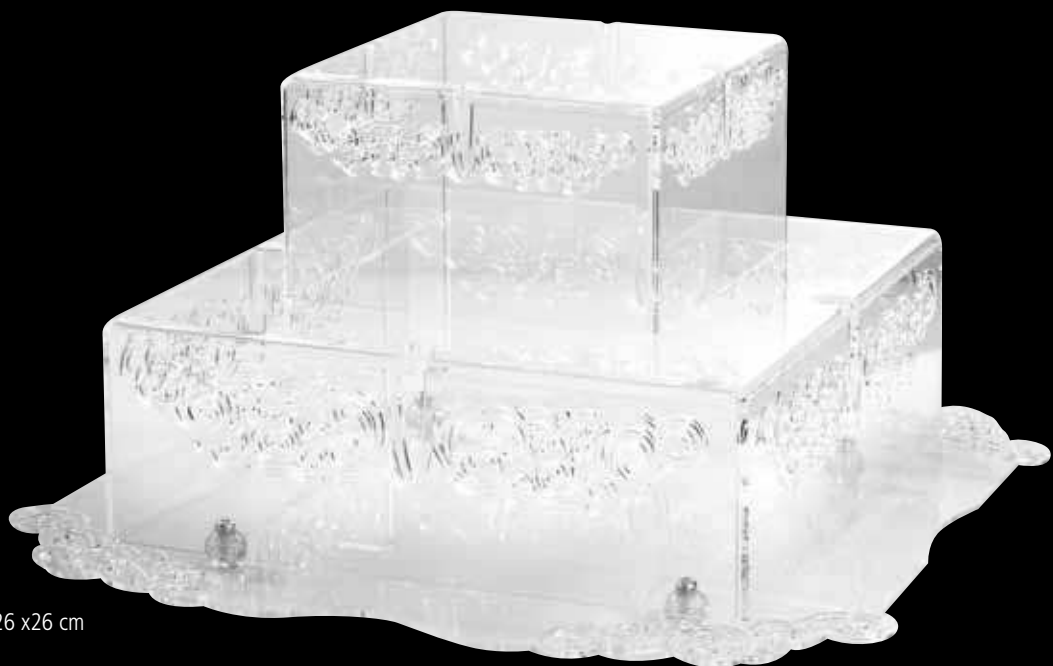

Cod. **33001**

Misura - Size: 64x64 - h 33 cm
Piatti - Plate: 64x64 - 44x44 - 26 x26 cm



Cod. 305

Misura - Size: Ø 28 h29 - 38x30 h21 - 38x30 h13 - 38x30 h5 cm



Cod. 307

Misura - Size: 40x27 h29 - 40x27h 21 - 40x27 h13 - 40x27 h5 cm



Cod. 310

Misura - Size: 40x20 h12 - 40x18 h8 - 40x16 h4 cm



Cod. 603

Misura - Size: h 58 cm
 Piatti - Plate: Ø 50 - 42 - 34 - 26 - 18 cm



Cod. 315

Misura - Size: h 59 cm
 Piatti - Plate: Ø 45 - 35 - 26 - 17 cm

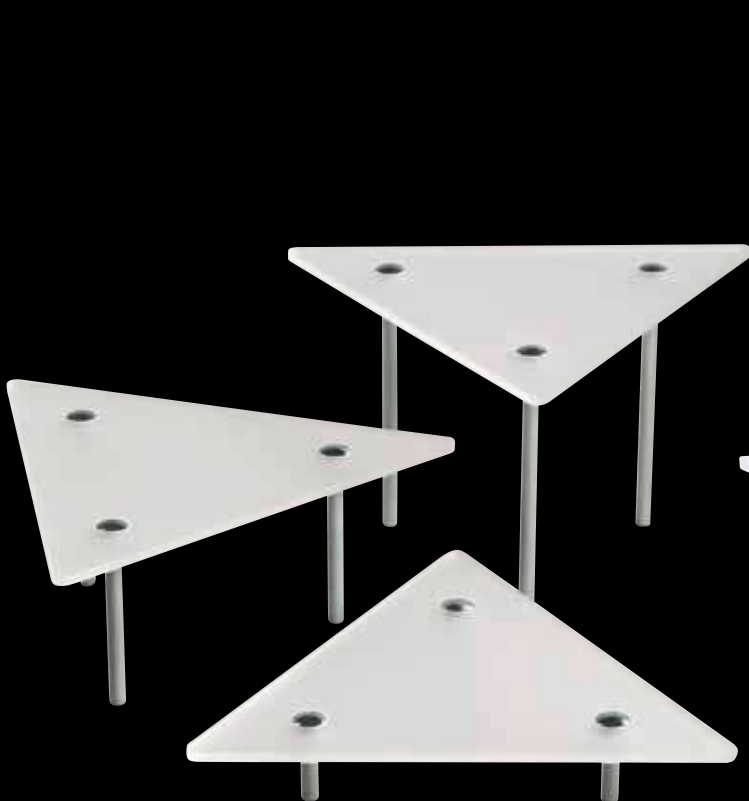

Cod. 313

Misura - Size: h 7 - 14 - 22 cm
 Piatti - Plate: 37x32 cm



Cod. 314

Misura - Size: h 6 - 14 - 22 - 30 cm
 Piatti - Plate: 47x24 cm



Cod. 410

Misura - Size: 45x45 - h32 cm
Piatti - Plate: (2) Ø 25 cm - (1) Ø 30 cm



Cod. 411

Misura - Size: 65x40 - h30 cm
Piatti - Plate: 28x40 - 25x35 - 21x30 cm



Cod. 412

Misura - Size: 65x40 - h30 cm
Piatti - Plate: 40x28 - 35x24 - 30x21 cm

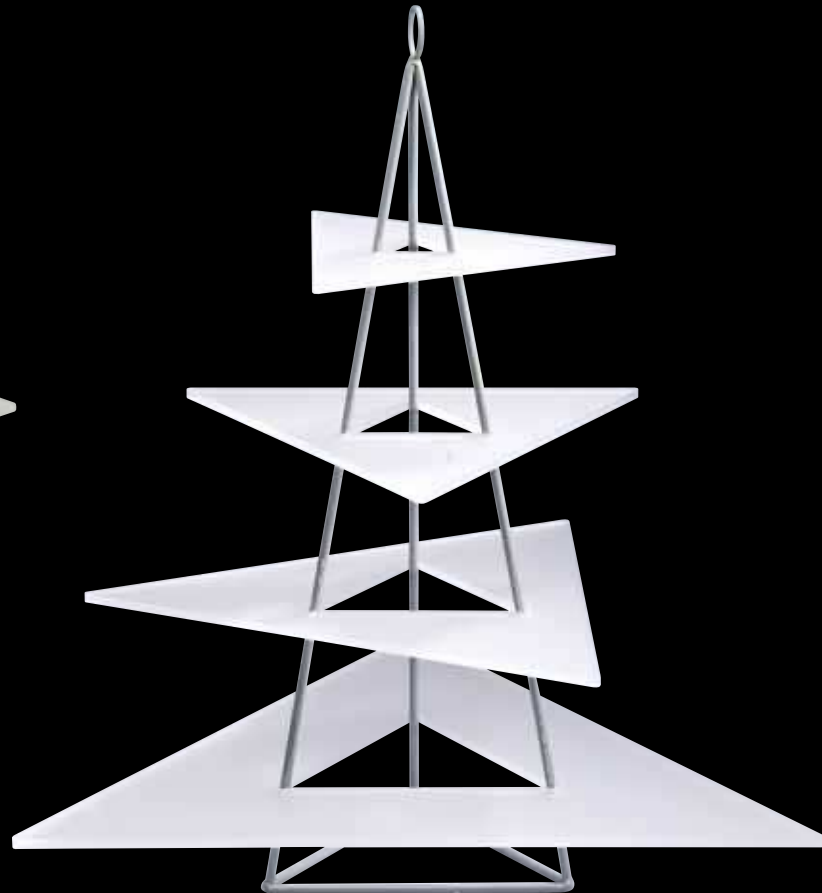

Cod. 312

Misura - Size: h 72 cm
Piatti - Plate: 65x57 - 42x48 - 34x39 - 25x29 cm



Cod. 500

Misura - Size: h 50 cm

Piatti - Plate: 33x33 - 28x28 - 22x22 cm



Cod. 501

Misura - Size: h 50 cm

Piatti - Plate: Ø40 - Ø32 - Ø26 cm



Cod. 502

Misura - Size: h 50 cm

Piatti - Plate: 39x49 - 30x40 - 22x32 cm



Cod. 503

Misura - Size: h 50 cm

Piatti - Plate: 36x55 - 25x50 - 22x45 cm

CATERING DISPLAYS

■ Cod. **403.01**
Bianco - White

□ Cod. **403.02**
Nero - Black

Misura - Size: Ø50 - h 21 cm
Ciotole/Piatti - Bowls/Plates: 18x18 h 10 cm



■ Cod. **404.01**
Bianco - White

□ Cod. **404.02**
Nero - Black

Misura - Size: 100x40 - h 20 cm
Ciotole/Piatti - Bowls/Plates: 33x12 - h 7,5 cm

■ Cod. **405.01**
Bianco - White

□ Cod. **405.02**
Nero - Black

Misura - Size: 70x43 - h 14 cm
Ciotole/Piatti - Bowls/Plates: 30x30 - h 5 cm - 33x12 - h 7,5 cm



■ Cod. **406.01**
Bianco - White

□ Cod. **406.02**
Nero - Black

Misura - Size: Ø 30 - h 7 cm
Ciotole/Piatti - Bowls/Plates: 30x30 - h 5 cm



■ Cod. **407.01**
Bianco - White

□ Cod. **407.02**
Nero - Black

Misura - Size: Ø 30 - h 14 cm
Ciotole/Piatti - Bowls/Plates: 30x30 - h 5 cm



■ Cod. **408.01**
Bianco - White

□ Cod. **408.02**
Nero - Black

Misura - Size: Ø 30 - h 18 cm
Ciotole/Piatti - Bowls/Plates: 30x30 - h 5 cm

■ Cod. **400.01**
Bianco - White

□ Cod. **400.02**
Nero - Black

Misura - Size: Ø 56 - h 57 cm
Ciotole/Piatti - Bowls/Plates: 21x21 - h 5,5 cm



■ Cod. **401.01**
Bianco - White

□ Cod. **401.02**
Nero - Black

Misura - Size: Ø 56 - h 57 cm
Ciotole/Piatti - Bowls/Plates: 30x30 - h 5 cm



■ Cod. **402.01**
Bianco - White

Misura - Size: Ø 56 - h 57 cm
Ciotole/Piatti - Bowls/Plates: Ø 26 - h 1,5 cm
Ideal for cake





Ciotola triangolare con base per incastro.
Triangular bowls with base to wedge it in serving stand.

■ Cod. **P400.01**
Bianco - White

□ Cod. **P400.02**
Nero - Black

Misura - Size: 21x21 h 5,5 cm
Capacità - Capacity: 600 ml

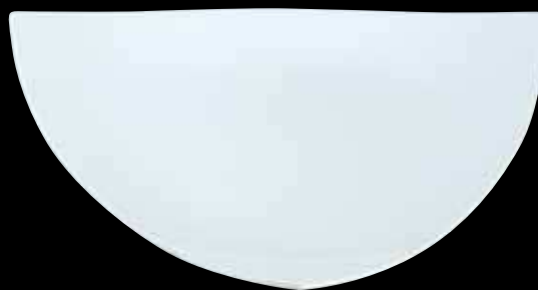

Piatto triangolare con base per incastro.
Triangular plates with base to wedge it in serving stand.

■ Cod. **P401.01**
Bianco - White

□ Cod. **P401.02**
Nero - Black

Misura - Size: 30x30 h 5 cm

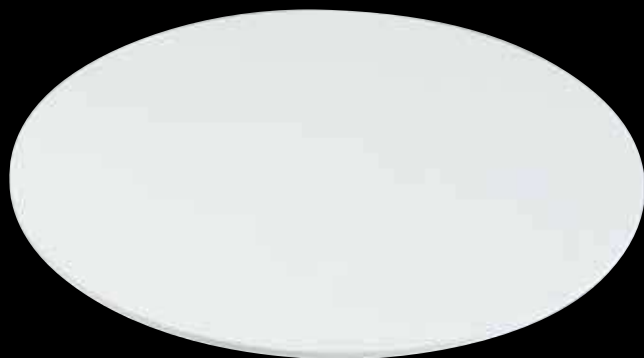

Piatto tondo con base per incastro.
Round plate with base to wedge it in serving stand.

■ Cod. **P402**
Bianco - White

Misura - Size: Ø 26 - h 1,5 cm



Ciotola triangolare.
Deep triangular bowls.

■ Cod. **P403.01**
Bianco - White

□ Cod. **P403.02**
Nero - Black

Misura - Size: 18x18 - h 10 cm
Capacità - Capacity: 900 ml

Ciotola a barchetta.
Deep boat bowls.

■ Cod. **P404.01**
Bianco - White

□ Cod. **P404.02**
Nero - Black

Misura - Size: 33x12 - h 7,5 cm
Capacità - Capacity: 1000 ml



COCKTAIL TRAYS



■ Cod. **MT101.01**
Bianco - White

□ Cod. **MT101.02**
Nero - Black

Misura - Size: 23x23 - h 3 cm
Pack 20 pcs



■ Cod. **MT103.01**
Bianco - White

□ Cod. **MT103.02**
Nero - Black

Misura - Size: 24x22 - h 3 cm
Pack 20 pcs



Cod. **MT501**
Misura - Size: 42x29 h 5,5 cm



Cod. **MT504**
Misura - Size: 59x29 h 5,5 cm



Cod. **MT505**
Misura - Size: 60x33 h 5,5 cm



Cod. **MT506**
Misura - Size: 42x35 h 5,5 cm

Vassoi neri in plexiglass inciso
Engraved black plexiglass trays

cod. 21-18651	180x65 mm	5 pcs
cod. 21-16161	164x164 mm	5 pcs
cod. 21-24701	240x70 mm	5 pcs
cod. 21-33161	330x164 mm	5 pcs
cod. 21-35781	351x78 mm	5 pcs
cod. 21-35241	359x247mm	5 pcs



cod. 21-18652	180x65 mm	5 pcs
cod. 21-16162	164x164 mm	5 pcs
cod. 21-24702	240x70 mm	5 pcs
cod. 21-33162	330x164 mm	5 pcs
cod. 21-35782	351x78 mm	5 pcs
cod. 21-35242	359x247mm	5 pcs



cod. 21-18653	180x65 mm	5 pcs
cod. 21-16163	164x164 mm	5 pcs
cod. 21-24703	240x70 mm	5 pcs
cod. 21-33163	330x164 mm	5 pcs
cod. 21-35783	351x78 mm	5 pcs
cod. 21-35243	359x247mm	5 pcs

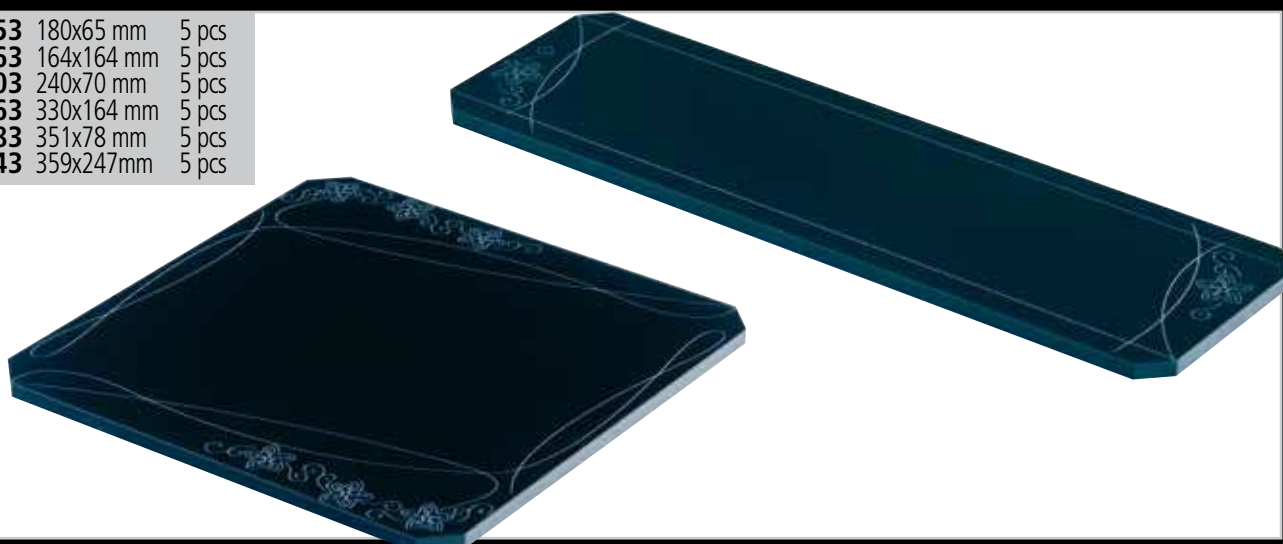



Vassoio a specchio ottagonale
Octagonal mirror tray

Cod. **MT600**

Misura - Size: 32,5x32,5 h 3,5 cm



Vassoio a specchio ovale
Oval mirror tray

Cod. **MT601**

Misura - Size: 45x30 h 3,5 cm



Vassoio a specchio quadrato
Square mirror tray

Cod. **MT602**

Misura - Size: 30x30 h 3,5 cm



Vassoio a specchio rettangolare
Rectangular mirror tray

Cod. **MT603**

Misura - Size: 45x30 h 3,5 cm



Vassoio a specchio tondo
Round mirror tray

Cod. **MT604**

Misura - Size: Ø35 h 3,5 cm



Vassoio nero ottagonale
Octagonal black tray

Cod. **MT700**

Misura - Size: 42x42 h 3,5 cm



Vassoio nero ovale
Oval black tray

Cod. **MT701**

Misura - Size: 55x35 h 3,5 cm



Vassoio nero quadrato
Square black tray

Cod. **MT702**

Misura - Size: 35x35 h 3,5 cm



Vassoio nero rettangolare
Rectangular black tray

Cod. **MT703**

Misura - Size: 55x35 h 3,5 cm



Vassoio nero tondo
Round black tray

Cod. **MT704**

Misura - Size: Ø45 h 3,5 cm



Vassoio nero virgola
Comma black tray

Cod. **MT705**

Misura - Size: 44,5x30 h 3,5 cm



Vassoio bianco e nero ottagonale
Octagonal white and black tray

Cod. **MT800**

Misura - Size: 32,5x32,5 h 3,5 cm



Vassoio bianco e nero ovale
Oval white and black tray

Cod. **MT801**

Misura - Size: 45x30 h 3,5 cm



Vassoio bianco e nero quadrato
Square white and black tray

Cod. **MT802**

Misura - Size: 30x30 h 3,5 cm



Vassoio bianco e nero rettangolare
Rectangular white and black tray

Cod. **MT803**

Misura - Size: 45x30 h 3,5 cm



Vassoio bianco e nero tondo
Round white and black tray

Cod. **MT804**

Misura - Size: Ø35 h 3,5 cm

Elegante vassoio in plastica trasparente.

Dotato di una valvola per la fuoriuscita dell'acqua e di un coperchio che permette di mantenere il ghiaccio ad un livello sottostante in modo da evitare il contatto con composizioni di frutta o altri alimenti.

Elegant transparent plastic tray.

It is equipped with a valve to let flow the water and with a cover which allows to keep the ice in a below level to avoid the contact with fruit composition or food.



Cod. **MIVA01**

Misura - Size: 52x76 h 8 cm

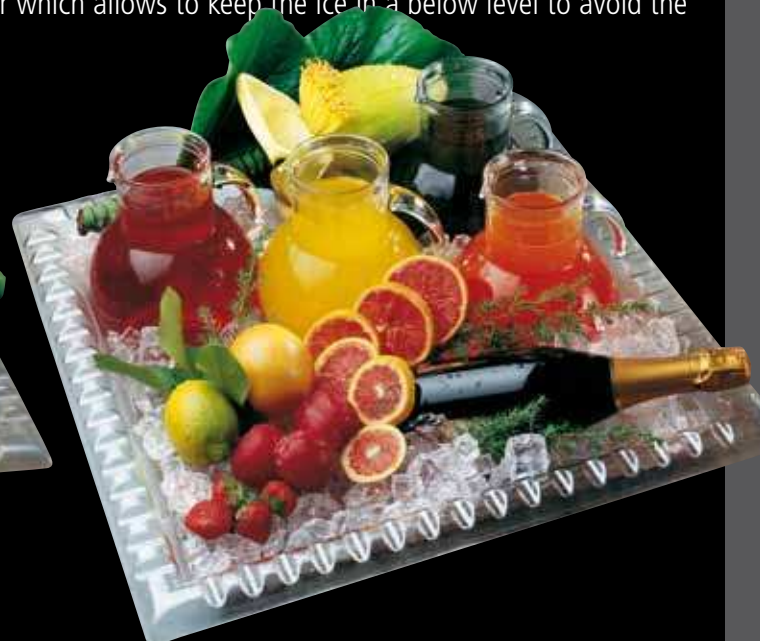

Cod. **MIVA02**

Misura - Size: 55x57 h 8 cm

CUPS AND GLASSES DISPLAYS

Bicchieri conico
Cone shaped glass

■ Cod. **BDM01.01**
Bianco - White

□ Cod. **BDM01.02**
Nero - Black

Misura - Size: Ø 6 - h 17 cm
Capacità - Capacity: 120 ml
Pack 20 pcs



Portacono
Glass holder

■ Cod. **PBO01.00**
Trasparente - Transparent

■ Cod. **PBO01.01**
Bianco - White

□ Cod. **PBO01.02**
Nero - Black

Misura - Size: 7x7 - h 11 cm
Pack 6 pcs



Struttura in metallo e portacono in plastica satinata
Metal structure and plastic satin-finished holder

Cod. **PBO01P2**

Misura - Size: 20x8,5 - h 24,5 cm
Capacità - Capacity: 2 bicchieri/glass BDM01
Pack 6 pcs

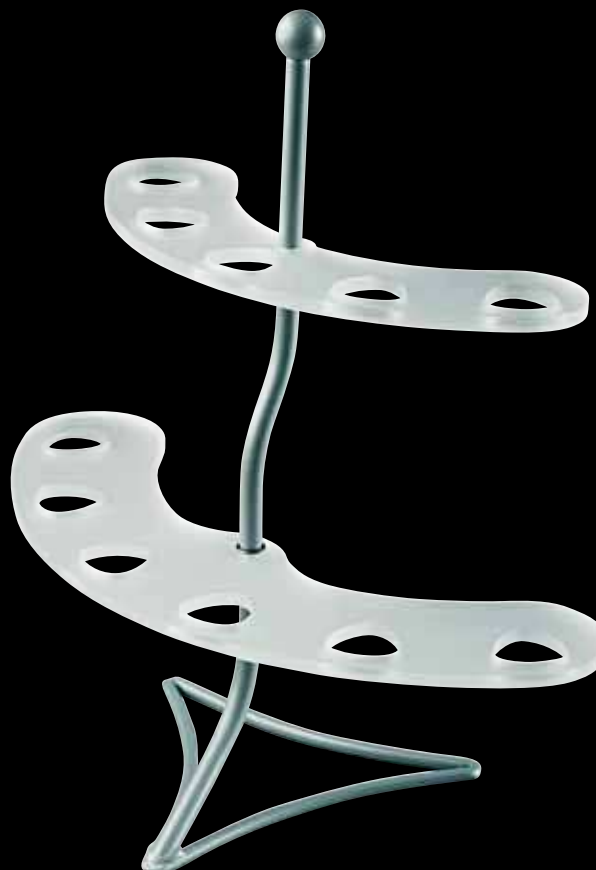

Struttura in metallo e portacono in plastica satinata
Metal structure and plastic satin-finished holder

Cod. **PBO01P11**

Misura - Size: 41x20 - h 44 cm
Capacità - Capacity: 11 bicchieri/glass BDM01
Pack 1 pcs



Coppette coniche
Cone shaped cups

 Cod. **PMO07.00**
Trasparente - Transparent

 Cod. **PMO07.01**
Bianco - White

 Cod. **PMO07.02**
Nero - Black

Misura - Size: Ø 8,5 - h 6,5 cm
Capacità - Capacity: 120 ml
Pack 100 pcs



Struttura in metallo e portacoppetta in plastica satinata
Metal structure and plastic satin-finished holder

Cod. **PBO07P2**
Misura - Size: 20x8 - h 24,5 cm
Capacità - Capacity: 2 coppette/cups PMO07
Pack 6 pcs



Struttura in metallo e portacoppetta in plastica satinata
Metal structure and plastic satin-finished holder

Cod. **PBO07P4**
Misura - Size: 19,5x19,5 - h 24,5 cm
Capacità - Capacity: 4 coppette/cups PMO07
Pack 6 pcs



Struttura in metallo e portacoppetta in plastica satinata
Metal structure and plastic satin-finished holder

Cod. **PBO07P9**
Misura - Size: 34x34 - h 36,5 cm
Capacità - Capacity: 9 coppette/cups PMO07
Pack 1 pcs

SHATTER-PROOF GLASSES

Realizzati in materiale innovativo, privo di BPA,
infrangibile e resistente ai lavaggi in lavastoviglie.

Made of innovative material, which is BPA free,
shatter-proof and dishwasher safe.



Cod. **PMOB001**
510 ml
Plastica trasparente
Transparent plastic
Pack 6 pcs

Cod. **PMOB003**
510 ml
Plastica trasparente
Transparent plastic
Pack 6 pcs



Cod. **PMOB002**
475 ml
Plastica trasparente
Transparent plastic
Pack 6 pcs



Cod. **BDM02**
240 ml
Plastica trasparente - Transparent plastic
Misura - Size: Ø60 - h 160 mm
Pack 20 pcs

REUSABLE MOULDS ICE SCULPTURE

MULTI ICE revolution

Multi Ice Revolution. Stampi in speciale materiale plastico con l'aggiunta di uno strato esterno di resina arancione che conferisce ai due gusci più elasticità e resistenza durante l'espansione del ghiaccio. La guarnizione siliconica posizionata all'interno del guscio ed il sistema di fissaggio composto da un kit di volantini non permettono la fuoriuscita dell'acqua e consentono di riutilizzare più volte lo stampo.

Grazie alla linea Multi Ice Revolution, composta da 18 stampi di diverso tipo, prendono forma eleganti sculture di ghiaccio adatte a stupire gli ospiti e a rendere unica l'esposizione del vostro banchetto.

Multi Ice Revolution. Moulds made of special plastic with an additional external orange resin layer which makes the two shells more elastic and more resistant against ice expansion. The silicone packing inside the shell and the fixing screws do not let the water come out and assure that the mould can be reused many times.

The Multi Ice Revolution collection, with its 18 different moulds, gives the possibility to create elegant ice sculptures that can impress your guests and make your banquet unique.



HOW TO USE



1
Inserire il supporto per la pompetta.
Insert the support for the air pump.



2
Unire i due gusci.
Combine the two shells.



3
Chiudere ermeticamente.
Seal the mould hermetically.



4
Riempire lo stampo con acqua distillata.
Fill the mould with distilled water.



Inserire il tubo e collegarlo alla pompa.
Insert the pipe and connect the pipe to the pump.



Mettere lo stampo in abbattitore. Per ottenere una scultura più trasparente è consigliabile prolungare il processo di congelazione. La temperatura consigliata è tra i -10°C e i -20°C .

Put the mould inside a freezer. In order to obtain a more transparent sculpture it is advisable to prolong the process of freezing as much as possible. The recommended temperature should go from -10°C to -20°C .



Lasciare lo stampo a temperatura ambiente per 10 minuti, procedere con la rimozione dei gusci.
Leave the mould at room temperature for 10 minutes and then remove the fasteners.



Aprire lo stampo quando si trova in posizione orizzontale.
Lay down the mould horizontally on a table and then remove the two shells.



Estrarre la scultura dallo stampo.
Extract the sculpture from the mould.



Rimuovere il ghiaccio in eccesso con l'aiuto di un cutter.
Remove the exceeding ice with the help of a cutter.



Pulire la scultura con un cannello o con un panno.
Polish the sculpture with a mini torch or a cloth.



Cod. MIR01

Scultura - Sculpture: 42x26 h 53cm

Stampo - Mould: 60x25 h 65cm - 7kg

Supporto per pompetta disponibile vedi accessori aggiuntivi.

This item is equipped with Air pump support - look at the additional accessories



Cod. MIR02

Scultura - Sculpture: 47x26 h 56cm

Stampo - Mould: 67x29 h 62cm - 8kg

Supporto per pompetta disponibile vedi accessori aggiuntivi.

This item is equipped with Air pump support - look at the additional accessories



Cod. MIR03

Scultura - Sculpture: 37x25 h 58cm

Stampo - Mould: 65x25 h 69cm - 7kg

Supporto per pompetta disponibile vedi accessori aggiuntivi.

This item is equipped with Air pump support - look at the additional accessories



Cod. MIR04

Scultura - Sculpture: 48x56 h 15cm

Stampo - Mould: 60x61 h 15cm - 7kg

Supporto per pompetta non disponibile.

No Air pump support available.



Cod. MIR05

Scultura - Sculpture: 36x26 h 67cm

Stampo - Mould: 50x26 h 78cm - 7,5kg

Supporto per pompetta disponibile vedi accessori aggiuntivi.

This item is equipped with Air pump support - look at the additional accessories



Cod. MIR08

Scultura - Sculpture: 58x25 h 56cm

Stampo - Mould: 69x25 h 70cm - 8kg

Supporto per pompetta disponibile vedi accessori aggiuntivi.

This item is equipped with Air pump support - look at the additional accessories



Cod. MIR07

Scultura - Sculpture: 41x41 h 83cm
 Stampo - Mould: 51x96 h 41cm - 9kg
 Supporto per pompetta non disponibile.
 No Air pump support available.

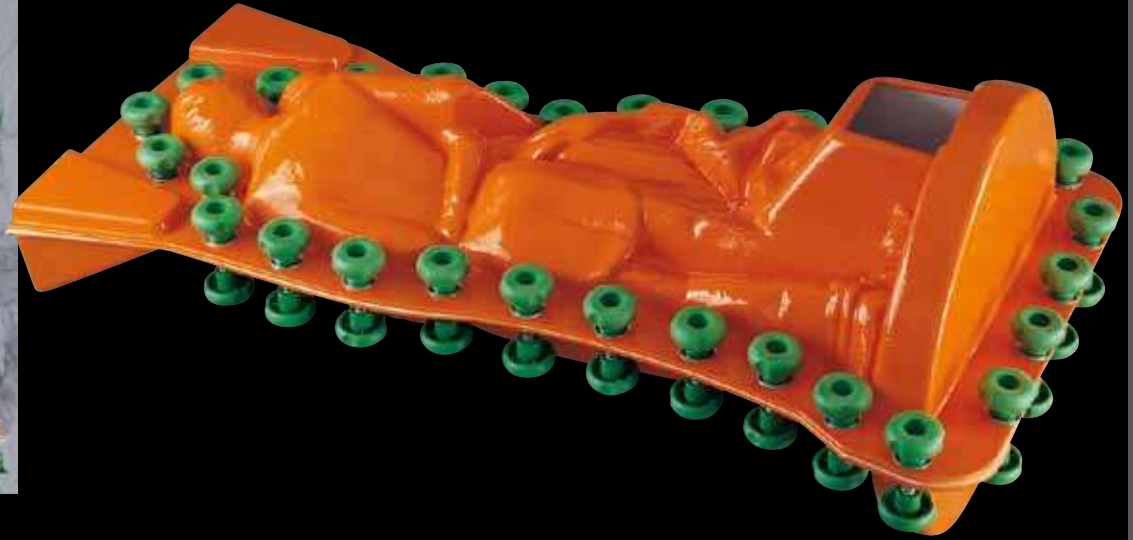

Cod. MIR10

Scultura - Sculpture: 46x33 h 86cm
 Stampo - Mould: 60x100 h 33cm - 8kg
 Supporto per pompetta non disponibile.
 No Air pump support available.

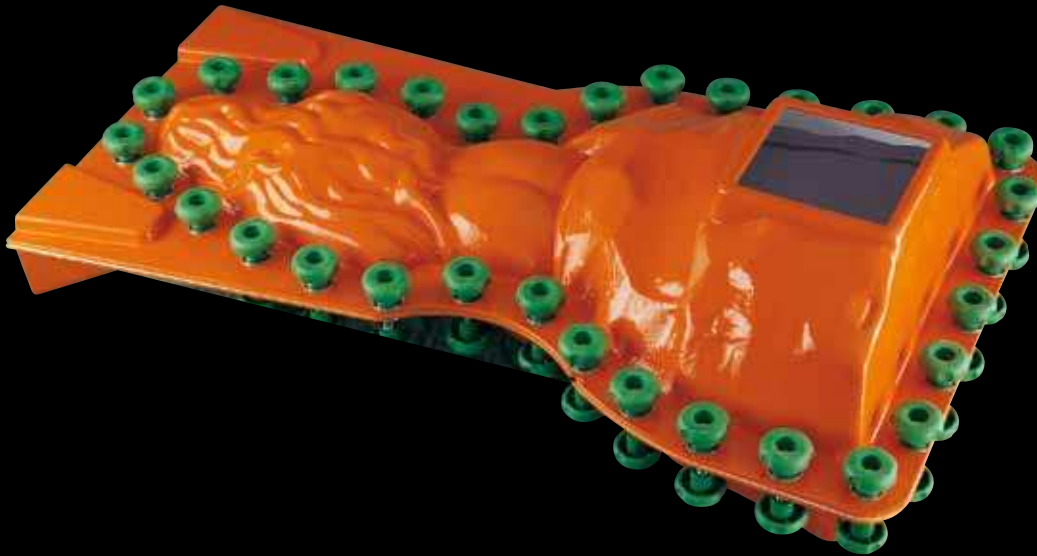

Cod. MIR11

Scultura - Sculpture: 35x25 h 71cm
 Stampo - Mould: 53x26 h 82cm - 6kg
 Supporto per pompetta disponibile vedi accessori aggiuntivi.
 This item is equipped with Air pump support - look at the additional accessories





Cod. MIR12

Scultura - Sculpture: 48x56 h 19cm
 Stampo - Mould: 71x56 h 20cm - 5,5kg
 Supporto per pompetta non disponibile.
 No Air pump support available.



Cod. MIR13

Scultura - Sculpture: Ø48 h 19cm
 Stampo - Mould: Ø62 h 20cm - 5kg
 Supporto per pompetta non disponibile.
 No Air pump support available.



Cod. MIR16

Scultura - Sculpture: Ø40 h 20cm
 Stampo - Mould: Ø52 h 23cm - 4kg
 Supporto per pompetta non disponibile.
 No Air pump support available.



Cod. MIR17

Scultura - Sculpture: Ø39 h 15cm
 Stampo - Mould: Ø53 h 19cm - 4,5kg
 Supporto per pompetta non disponibile.
 No Air pump support available.



Cod. MIR18

Scultura - Sculpture: Ø51 h 22cm
 Stampo - Mould: Ø63 h 24cm - 5kg
 Supporto per pompetta non disponibile.
 No Air pump support available.



ACCESSORIES FOR ICE SCULPTURE

La pompetta tiene in movimento l'acqua all'interno dello stampo durante il processo di congelazione. Con l'aiuto di questi accessori la scultura di ghiaccio risulterà più trasparente.

The Air pump makes the water circulate inside the mould during the process of freezing. With the help of this accessory, the resulting ice sculpture will be more transparent.



Cod. **MIP**

Supporto per pompetta - Air pump support

cod. MIS01	suitable for:	MIR01
cod. MIS02	suitable for:	MIR02
cod. MIS03	suitable for:	MIR03
cod. MIS05	suitable for:	MIR05
cod. MIS08	suitable for:	MIR08
cod. MIS11	suitable for:	MIR11

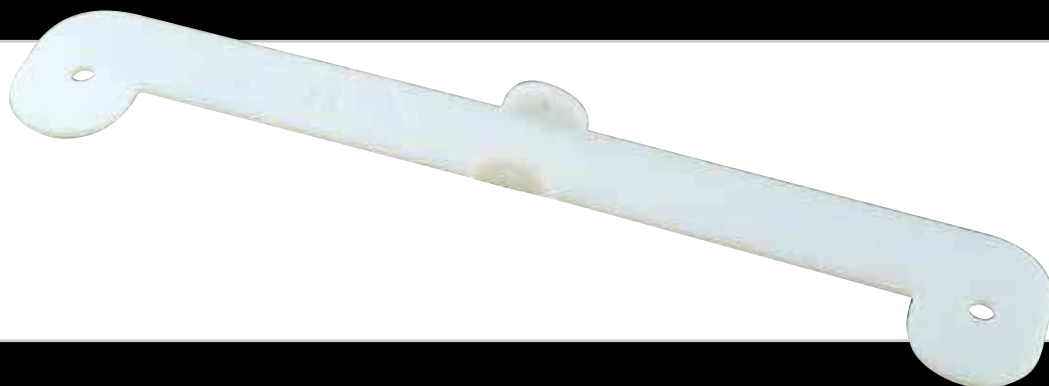

PLEXIGLASS STANDS



Cod. 504

Misura - Size: h 125 cm
Piatti - Plates: Ø 20 - 22 - 26 - 28 - 30 cm
Piatti in plexiglass satinato
Glazed plexiglass plate



Cod. 510

Misura - Size: 41x41 - h 67 cm

Piatti - Plates: 40x40 - 35x35 - 30x30 - 20x20 cm



Cod. 311

Misura - Size: 60x70 h 79 cm

Piatti - Plates: Ø 25



Cod. 511

Misura - Size: 41x41 - h 67 cm

Piatti - Plates: 40x40 - 35x35 - 30x30 - 20x20 cm



PLASTIC STANDS





Cod. 507

Misura - Size: h 41 cm
Piatti - Plates:
1 piano/level Ø 15cm
1 piano/level Ø 30 cm



Cod. 508

Misura - Size: h 41 cm
Piatti - Plates:
1 piano/level Ø 25 cm
1 piano/level Ø 49 cm



Cod. 509

Misura - Size: h 75 cm
Piatti - Plates:
1 piano/level Ø 15 cm
1 piano/level Ø 30 cm
1 piano/level Ø 50 cm

Unendo le alzate:
COD. 507 (senza i piedini)
con **COD. 508**
si ottiene **COD. 509**

Combining the cake stands:
COD. 507 (no feet)
with **COD. 508**
you get **COD. 509**

Accessori e ricambi
Accessories and spare parts



Cod. FONTANINA

Misura - Size: Ø38 - h 40 cm
Fontana elettrica 12V
Electric fountain 12V



Cod. ANELLO

per base Ø85 cm e Ø 115 cm
for base Ø85 cm and Ø 115 cm



Cod. COLONNA

Colonna grande - Big column
adatta a - suitable for:
COD. 101 / 103 / 111



Cod. COLONNINA

Colonna piccola - Small column
adatta a - suitable for:
COD. 101 / 102 / 103 / 104 / 105 / 156
157 / 158 / 180

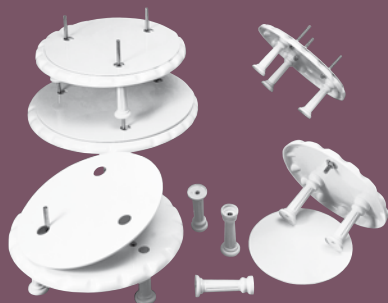

COD. 101

Misura - Size: h 120 cm
Piatti - Plates:
25 x 25 - 30 x 30 - 35 x 35 - 40 x 40 - 45 x 45 cm
Porz. - Portions: 145 - 155
Accessori (non inclusi) - Accessories (not included):
FONTANINA



COD. 102

Misura - Size: h 96 cm
Piatti - Plates:
25 x 25 - 30 x 30 - 35 x 35 - 40 x 40 - 45 x 45 cm
Porz. - Portions: 145 - 155



COD. 103

Misura - Size: h 120 cm
Piatti - Plates:
Ø 25 - 30 - 35 - 40 - 48 cm
Porz. - Portions: 100 - 110
Accessori (non inclusi) - Accessories (not included):
FONTANINA



COD. 104

Misura - Size: h 86 cm
Piatti - Plates:
Ø 25 - 30 - 35 - 40 - 48 cm
Porz. - Portions: 100 - 110



Base abbinabile a molte alzate.
Base that can be combined with
many cake stands.

COD. 118

Misura - Size: h 23 cm
Piatti - Plates:
Ø 85 cm
Porz. - Portions: 85 - 95



Base abbinabile a molte alzate.
Base that can be combined with
many cake stands.

COD. 118/F

Misura - Size: h 30 cm
Piatti - Plates:
Ø 85 cm
Porz. - Portions: 70 - 80
Accessori (non inclusi) - Accessories (not included):
FONTANINA - SCI07



COD. 111

Misura - Size: h 100 cm
Piatti - Plates:
Ø 25 - 48 - 85 cm
Porz. - Portions: 90 - 100
Accessori (non inclusi) - Accessories (not included):
FONTANINA - SCI01 - SCI02



Cod. **SCI01**
per base - mould for base **COD. 111/112**



Cod. **SCI07**
per base - mould for base **COD. 118/F**

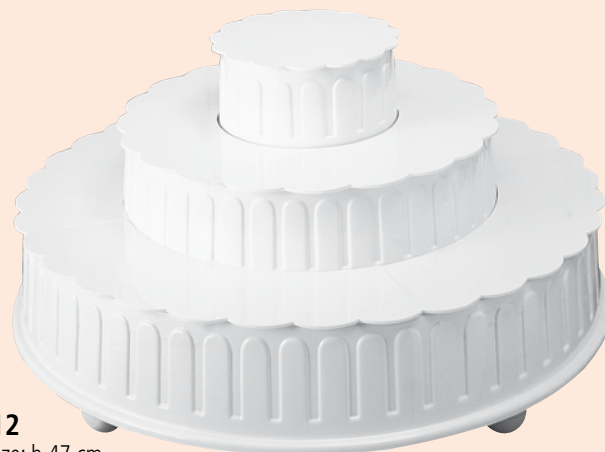

COD. 112

Misura - Size: h 47 cm
Piatti - Plates:
Ø 25 - 48 - 85 cm
Porz. - Portions: 90 - 100
Accessori (non inclusi) - Accessories (not included):
SCI01 - SCI02



Cod. **SCI02**
per II° piano - mould for **COD. 111/112**
Ø 48 cm



COD. 187

Misura - Size: 70x35 h 62 cm

Piatti - Plates:

1 piano/level 50 x 30 cm

Porz. - Portions: 25 - 30



COD. 187+118

Misura - Size: Ø83 h 85 cm

Piatti - Plates:

1 piano/level Ø 85 cm

1 piano/level 50 x 30 cm

Porz. - Portions: 110 - 120

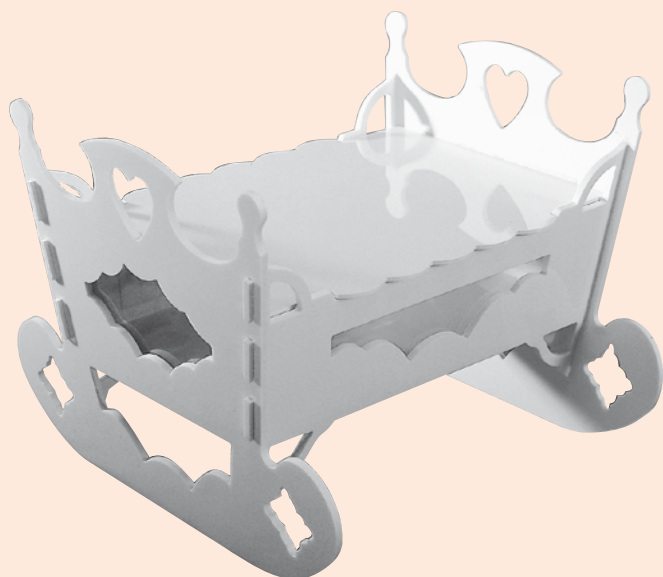

COD. 117

Misura - Size: h 38 cm

Piatti - Plates:

55 x 50 cm

Porz. - Portions: 25 - 30

Accessori (non inclusi) - Accessories (not included):

COD. 118

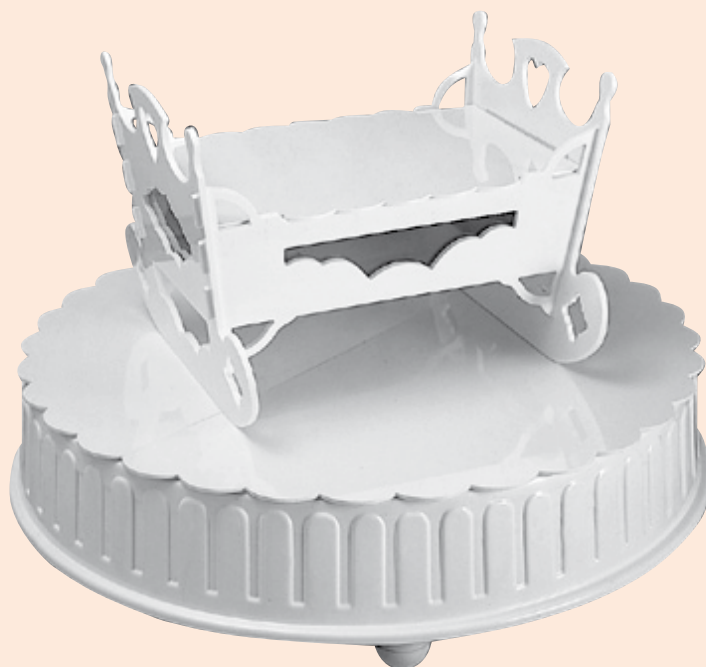

COD. 117+118

Piatti - Plates:

Ø85 cm

Porz. - Portions: 140 - 150



La base della conchiglia può essere riempita di ghiaccio per mantenere freschi i vostri prodotti.
The cake stand base can be filled with ice to keep your food fresh.

COD. 122

Misura - Size: h 70 cm

Piatti - Plates:

Ø 60 cm

Porz. - Portions: 35 - 45

Accessori (non inclusi) - Accessories (not included):

COD. 118 - SCI03



COD. 122+118

Piatti - Plates:

Ø 85 cm

Porz. - Portions: 120 - 140

Accessori (non inclusi) - Accessories (not included):

SCI03

Cod. **SCI03**

per base - mould for base **COD. 122**

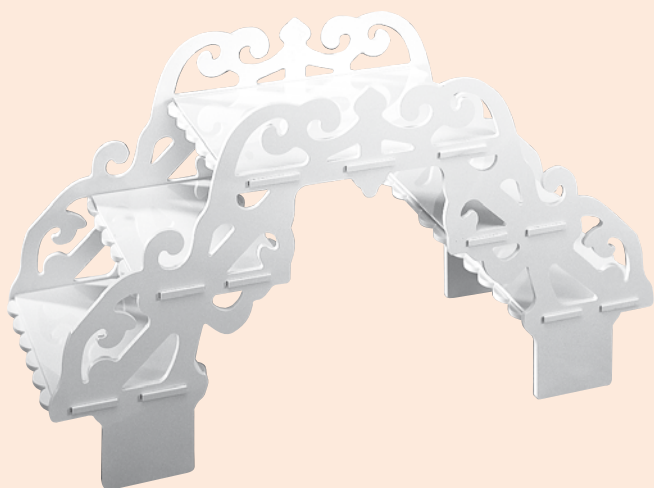

COD. 121

Misura - Size: 85 x 35 h 45 cm

Piatti - Plates:

4 piani/levels 29 x 19

1 piano/level 29 x 38 cm

Porz. - Portions: 70 - 80

Accessori (non inclusi) - Accessories (not included):

COD. 118

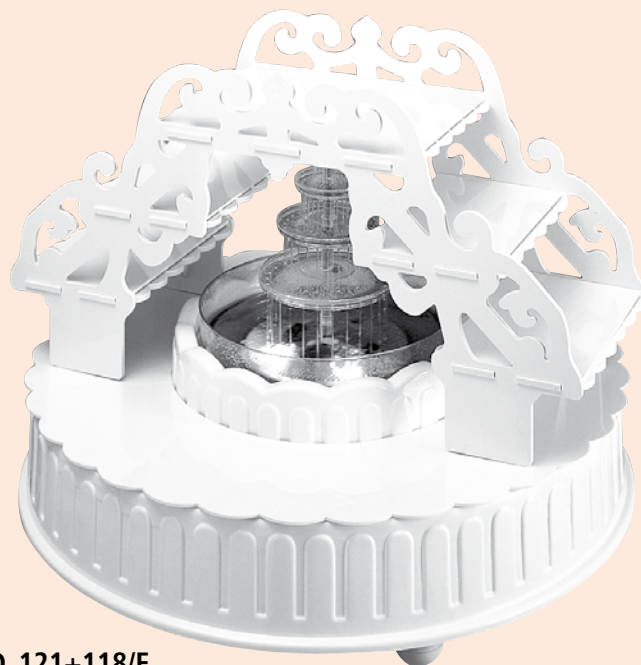

COD. 121+118/F

Piatti - Plates:

Ø85 cm

Porz. - Portions: 135 - 145

Accessori (non inclusi) - Accessories (not included):

FONTANINA

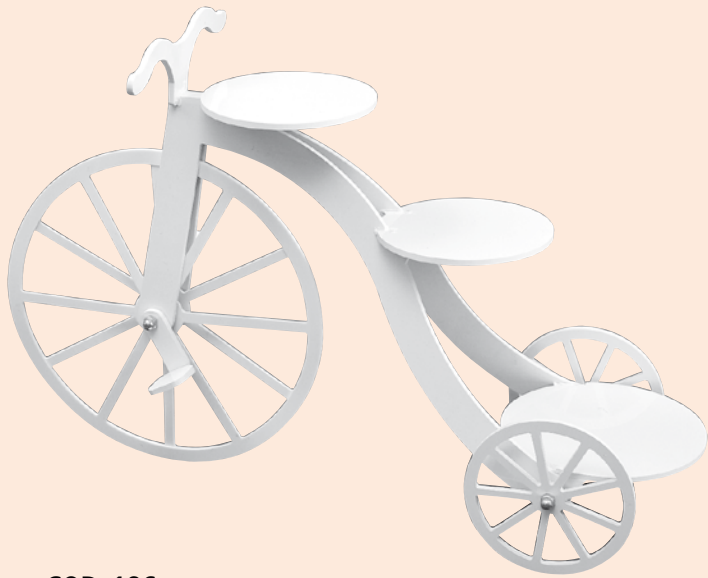

COD. 186

Misura - Size: 90x35 h 60 cm

Piatti - Plates:

2 piani/levels Ø 22 cm

1 piano/level Ø 26 cm

Porz. - Portions: 25 - 30



COD. 186+118

Misura - Size: Ø83 h 83 cm

Piatti - Plates:

1 piano/level Ø 85 cm

2 piani/levels Ø 22 cm

1 piano/level Ø 26 cm

Porz. - Portions: 110 - 120

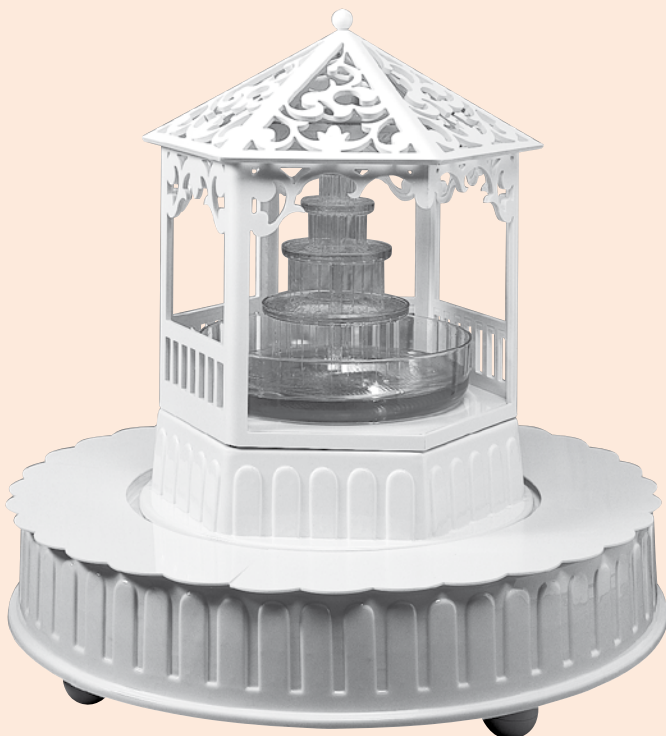

COD. 170

Misura - Size: Ø 85 h 90 cm

Piatti - Plates:

Ø 85 cm

Porz. - Portions: 60 - 80

Accessori (non inclusi) - Accessories (not included):

FONTANINA

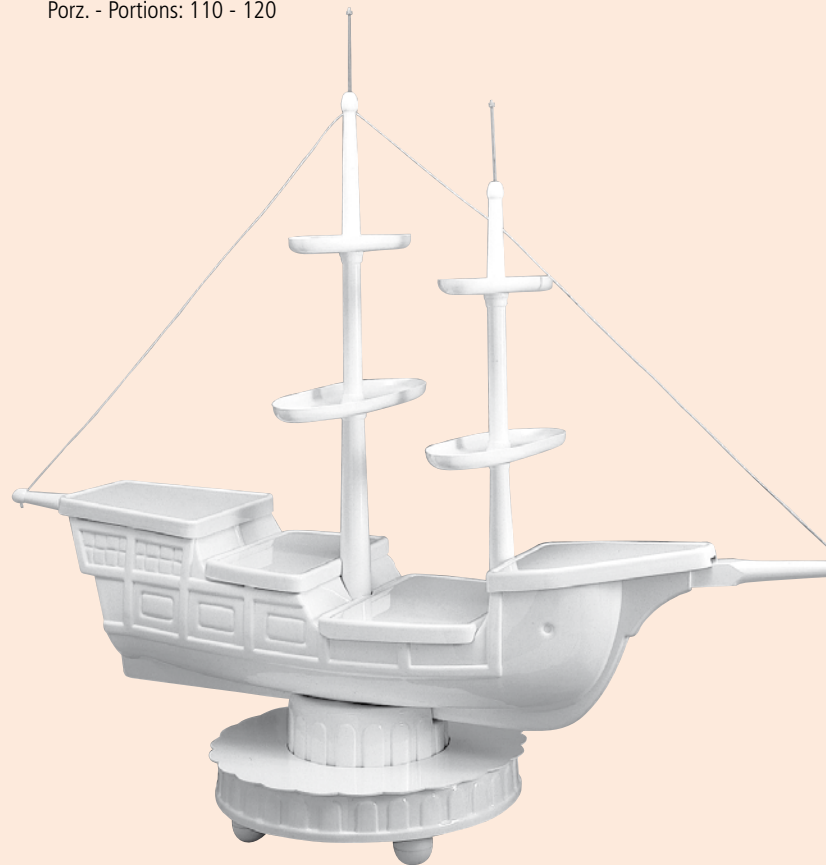

COD. 116

Misura - Size: h 130 cm - Piatti - Plates: 150 x 50 cm

Porz. - Portions: 95 - 105

Accessori (non inclusi) - Accessories (not included): **SCI04**



Cod. **SCI04**

set 4 pz. - set 4pcs for: **COD. 116**

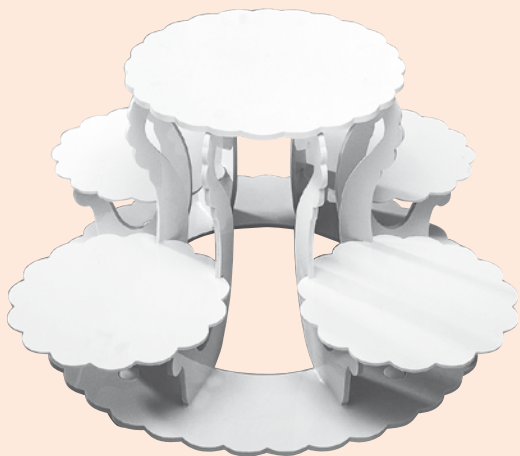

COD. 135

Misura - Size: h 42 cm
 Piatti - Plates:
 4 piani/levels Ø 26 cm
 1 piano/level Ø 38 cm
 Porz. - Portions: 65 - 75



COD. 136

Misura - Size: h 46 cm
 Piatti - Plates:
 8 piani/levels Ø 26 cm
 1 piano/level Ø 62 cm
 Porz. - Portions: 140 - 150

Unendo le alzate:
COD. 135 (senza i piedini)
COD. 136 (senza i piedini)
 con **COD. 137**
 si ottiene **COD. 138**

Combining the cake stands:
COD. 135 (no feet)
COD. 136 (no feet)
 with **COD. 137**
 you get **COD. 138**



COD. 137

Misura - Size: h 57 cm
 Piatti - Plates:
 8 piani/levels Ø 26 cm
 1 piano/level Ø 76 cm
 Porz. - Portions: 170 - 180
 Accessori (non inclusi) - Accessories (not included):
FONTANINA

COD. 138

Misura - Size: h 150 cm
 Piatti - Plates:
 20 piani/levels Ø 26 cm
 1 piano/level Ø 38 cm
 Porz. - Portions: 260 - 270
 Accessori (non inclusi) - Accessories (not included):
FONTANINA

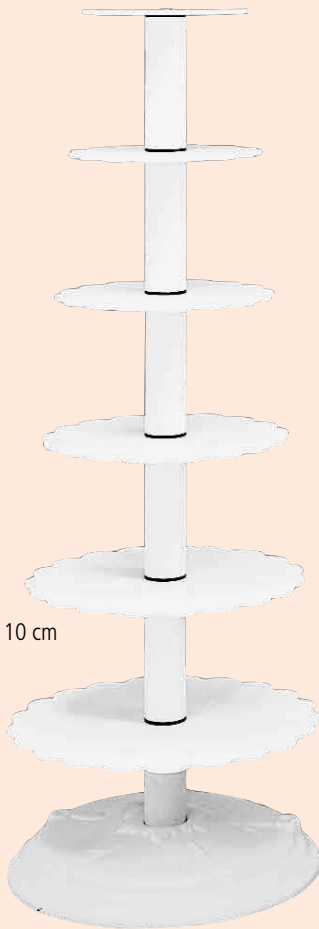

COD. 113/B

Misura - Size: h 110 cm

Piatti - Plates:

Ø 18 cm

Ø 22 cm

Ø 24 cm

Ø 28 cm

Ø 32 cm

Ø 36 cm

Porz. - Portions:

70 - 80

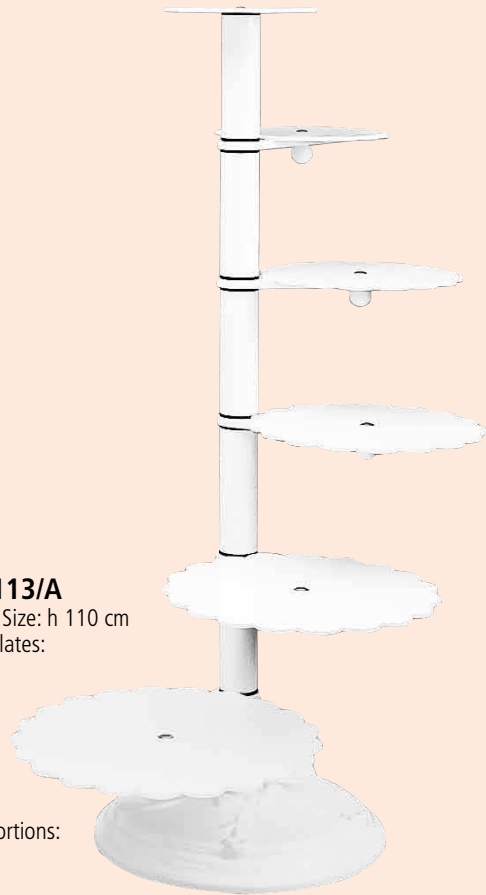

COD. 113/A

Misura - Size: h 110 cm

Piatti - Plates:

Ø 18 cm

Ø 22 cm

Ø 24 cm

Ø 28 cm

Ø 32 cm

Ø 36 cm

Porz. - Portions:

70 - 80

COD. 127

Misura - Size: h 140 cm

Piatti - Plates:

73 x 73 cm

Porz. - Portions:

85 - 95

Accessori (non inclusi) - Accessories (not included):

FONTANINA

Base con anello separatore incluso
Base with included separator ring

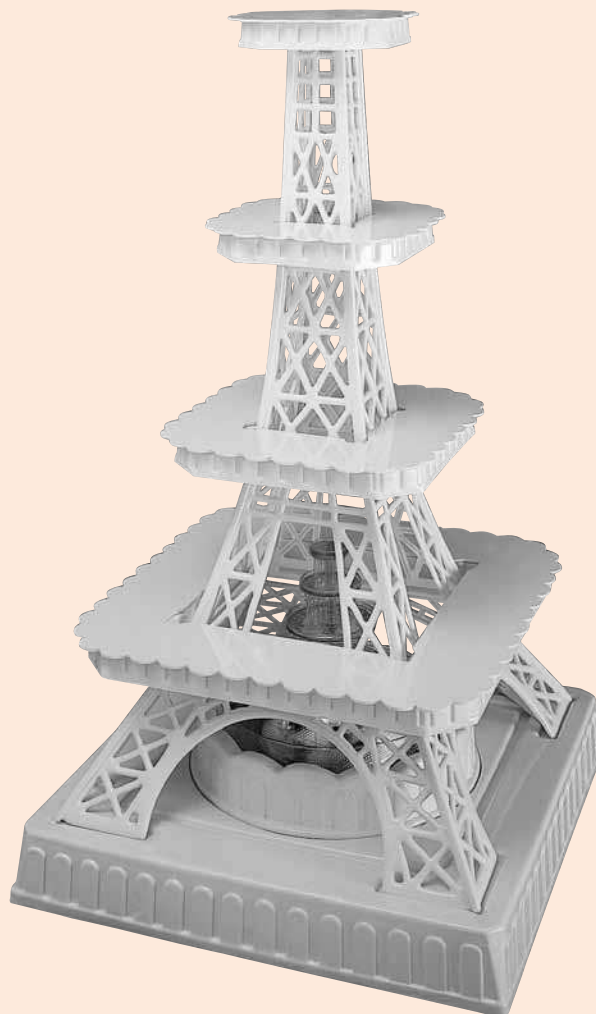

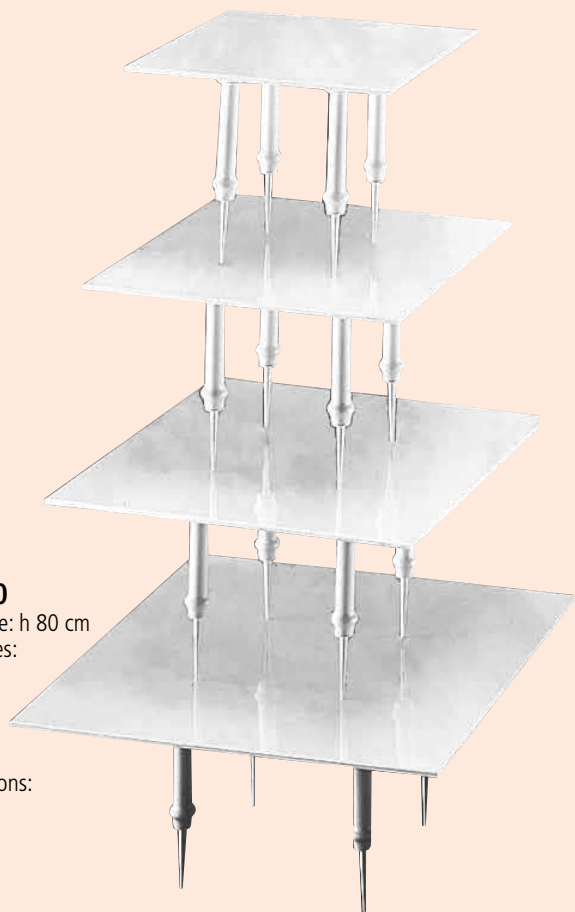

COD. 130

Misura - Size: h 80 cm
 Piatti - Plates:
 25 x 25 cm
 30 x 30 cm
 35 x 35 cm
 40 x 40 cm
 Porz. - Portions:
 80 - 85



COD. 131

Misura - Size: h 80 cm
 Piatti - Plates:
 Ø 24 cm
 Ø 29 cm
 Ø 34 cm
 Ø 39 cm
 Porz. - Portions:
 40 - 50



COD. 132

Misura - Size: h 80 cm
 Piatti - Plates:
 25 x 21 cm
 30 x 26 cm
 35 x 30 cm
 40 x 34 cm
 Porz. - Portions:
 40 - 50

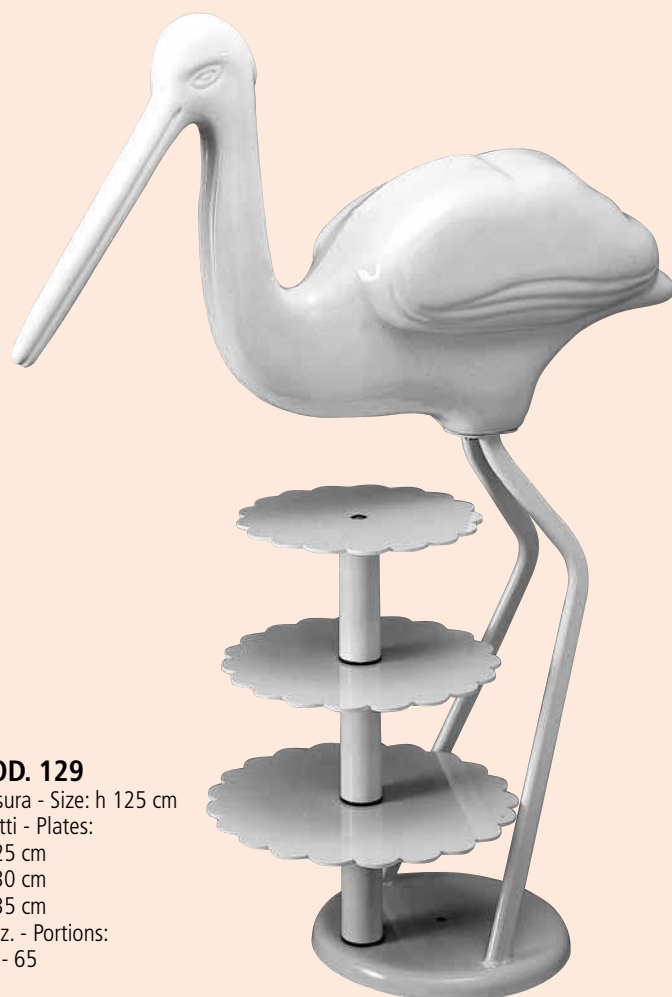

COD. 129

Misura - Size: h 125 cm
 Piatti - Plates:
 Ø 25 cm
 Ø 30 cm
 Ø 35 cm
 Porz. - Portions:
 55 - 65



COD. 152

Misura - Size: Ø 80 h 70 cm

Piatti - Plates:

5 piani/levels Ø 26 cm

5 piani/levels Ø 20 cm

1 piano/level Ø 34 cm

Porz. - Portions: 100 - 110



COD. 153

Misura - Size: 100 x 54 h 88 cm

Piatti - Plates:

3 piani/levels Ø 32 cm

3 piani/levels Ø 26 cm

1 piano/level Ø 38 cm

Porz. - Portions: 90 - 100



COD. 159

Misura - Size: Ø 65 h 85 cm

Piatti - Plates:

6 piani/levels Ø 26 cm

1 piano/level Ø 38 cm

Porz. - Portions: 100 - 110



COD. 192

Misura - Size: 62 x 62 h 38 cm

Piatti - Plates:

4 piani/levels Ø 20 cm

1 piano/level Ø 25 cm

Porz. - Portions: 30 - 35

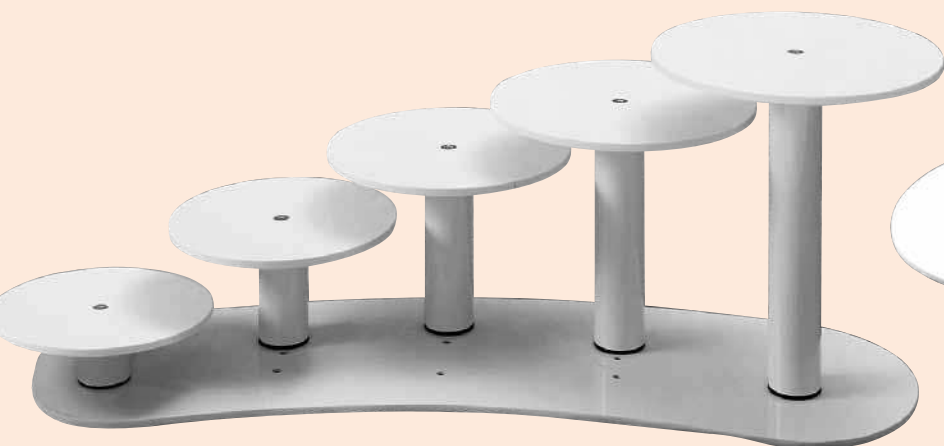

COD. 190

Misura - Size: 88 x 30 h 34 cm

Piatti - Plates:

2 piani/levels Ø 22cm

1 piano/level Ø 24 cm

1 piano/level Ø 26 cm

1 piano/level Ø 28 cm

Porz. - Portions: 45 - 55

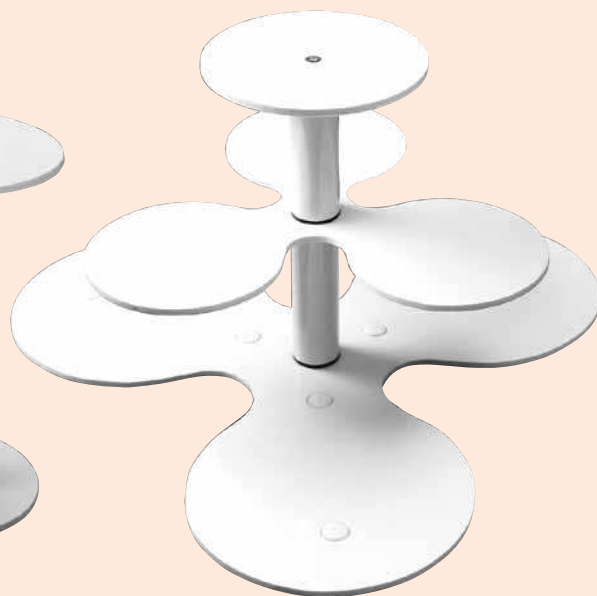

COD. 188

Misura - Size: 65x62 h 38 cm

Piatti - Plates:

3 piani/levels Ø 28 cm

3 piani/levels Ø 20 cm

1 piano/level Ø 22 cm

Porz. - Portions: 40 - 45



COD. 180

Misura - Size: Ø 90 h 45 cm

Piatti - Plates:

6 piani/levels Ø 28 cm

1 piano/level Ø 48 cm

1 piano/level Ø 30 cm

Porz. - Portions: 120 - 130



COD. 150

Misura - Size: h 80 cm

Piatti - Plates:

23 x 18 - 29 x 17 - 39 x 19 - 50 x 22 - 60 x 25 cm

Porz. - Portions: 75 - 85



COD. 161

Misura - Size: Ø 110 h51 cm

Piatti - Plates:

4 piani/levels Ø 34 cm

1 piano/level Ø 55 cm

Porz. - Portions: 105 - 115

Accessori (non inclusi) - Accessories (not included):

FONTANINA



COD. 162

Misura - Size: Ø 70 h42 cm

Piatti - Plates:

4 piani/levels Ø 26 cm

1 piano/level Ø 45 cm

Porz. - Portions: 80 - 90

Unendo le alzate:

COD. 161

COD. 162 (senza i piedini)
con

COD. 163 (senza i piedini)
si ottiene **COD. 160**

Combining the cake stands:

COD. 161

COD. 162 (no feet)
with

COD. 163 (no feet)
you get **COD. 160**



COD. 163

Misura - Size: Ø 40 h45 cm

Piatti - Plates:

3 piani/levels Ø 26 cm

1 piano/level Ø 32 cm

Porz. - Portions: 45 - 55

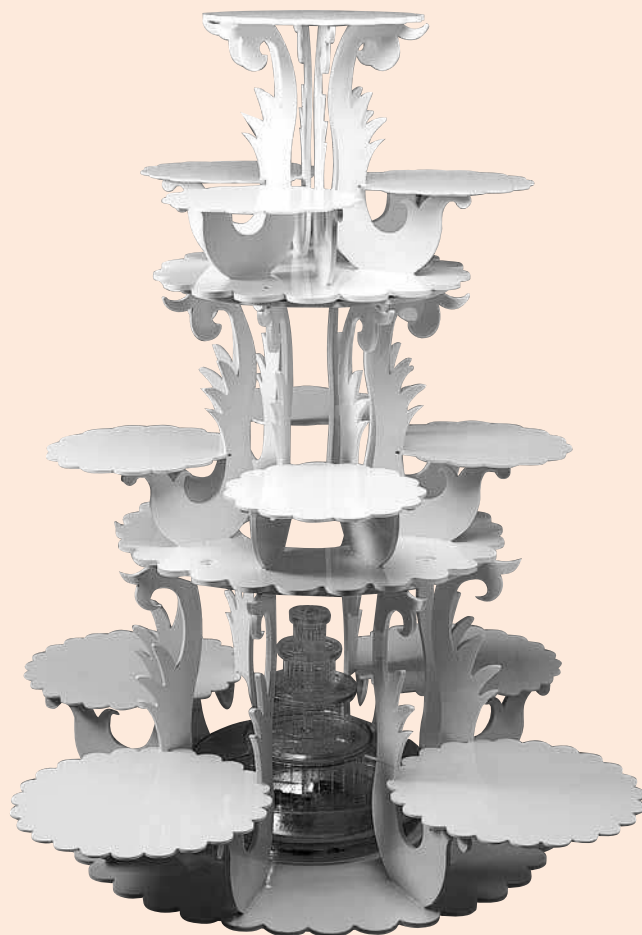

COD. 160

Misura - Size: Ø 110 h130 cm

Piatti - Plates:

4 piani/levels Ø 34 cm

7 piani/levels Ø 26 cm

1 piano/level Ø 32 cm

Porz. - Portions: 145 - 155

Accessori (non inclusi) - Accessories (not included):

FONTANINA

COD. 155

Misura - Size: h 65 cm

Piatti - Plates:

Ø 28 - 48 - 68 cm

Porz. - Portions: 60 - 70

Accessori (non inclusi) - Accessories (not included):

SCI09 - SCI10**Cod. SCI09**per base - mould for base **COD. 155**

Ø 68 cm

**Cod. SCI10**per II° piano - mould for 2nd floor **COD. 155**

Ø 48 cm

**COD. 156**

Misura - Size: h 85 cm

Piatti - Plates:

Ø 28 - 48 - 68 cm

Porz. - Portions: 75 - 85

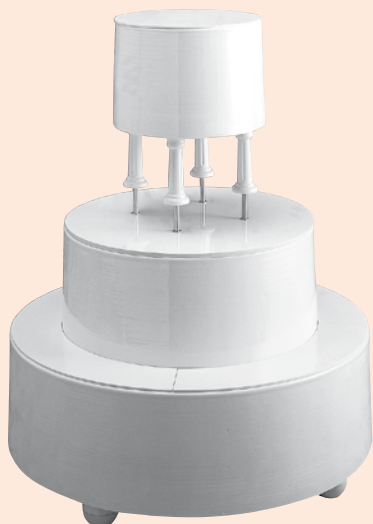
**COD. 157**

Misura - Size: h 85 cm

Piatti - Plates:

Ø 28 - 48 - 68 cm

Porz. - Portions: 95 - 105

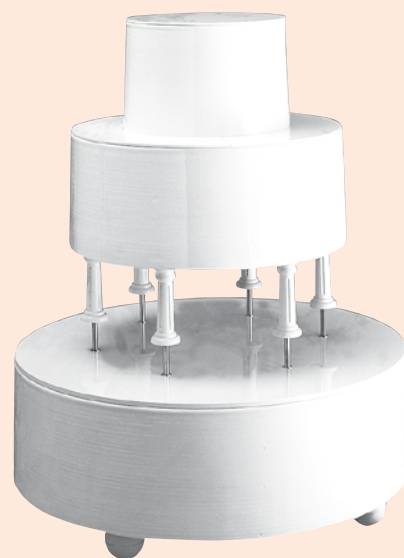
**COD. 158**

Misura - Size: h 105 cm

Piatti - Plates:

Ø 28 - 48 - 68 cm

Porz. - Portions: 105 - 115

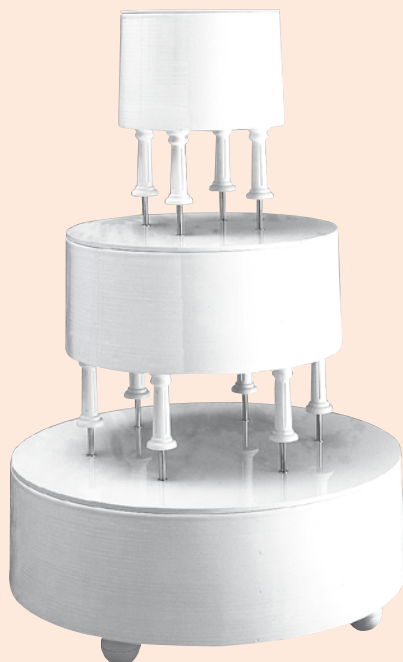
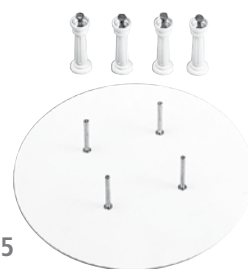
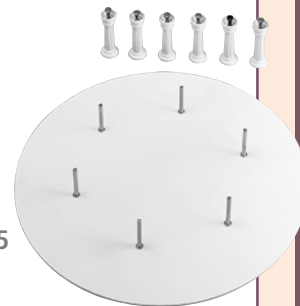
**Accessori e ricambi****Accessories and spare parts****Cod. KIT 1**Kit 4 colonne e 1 piatto Ø48 cm per: **COD. 155**Kit 4 columns and 1 plate Ø48 cm for: **COD. 155****Cod. KIT 2**Kit 4 colonne e 1 piatto Ø68 cm per: **COD. 155**Kit 4 columns and 1 plate Ø68 cm for: **COD. 155**



COD. 189

Misura - Size: 80 x 70 h 46 cm
 Piatti - Plates:
 5 piani/levels Ø 28 cm
 Porz. - Portions: 55 - 65



COD. 183

Misura - Size: Ø 70 h 50 cm
 Piatti - Plates:
 4 piani/levels Ø 30 cm
 Porz. - Portions: 50 - 60



COD. 196

Misura - Size: Ø 65 h 25 cm
 Piatti - Plates:
 5 piani/levels 32x16 cm
 5 piani/levels 20x10 cm
 1 piano/level Ø 18 cm
 Porz. - Portions: 55 - 60
 Accessori (non inclusi) - Accessories (not included):
SC196PI



Cod. **SC196PI**
 per base - mould for base **COD. 196**
 20x10 cm



COD. 184

Misura - Size: Ø 52 h 40 cm
Piatti - Plates:
Base: Ø 52 cm



COD. 185

Misura - Size: Ø 62 h 50 cm
Piatti - Plates:
Base: Ø 62 cm



COD. 196/B

Misura - Size: Ø 80 h 25 cm
Piatti - Plates:
5 piani/levels 40x20 cm
5 piani/levels 24x13 cm
1 piano/level Ø 22 cm
Porz. - Portions: 60 - 80
Accessori (non inclusi) - Accessories (not included):
SC196GR



Cod. **SC196GR**
per base - mould for base **COD. 196/B**
32x16 cm

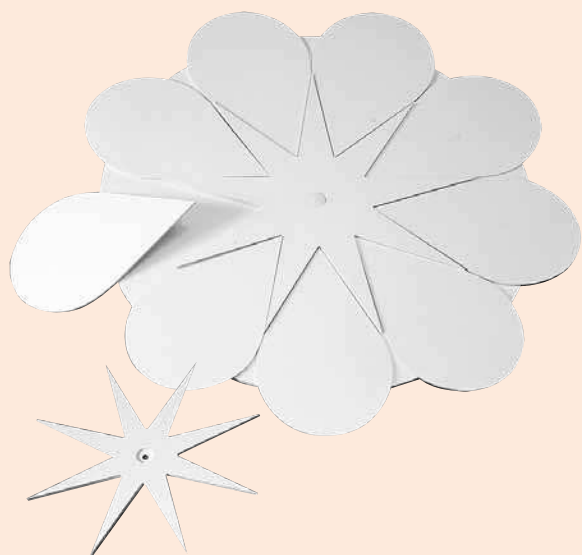

Porta torta a petali variabili a seconda delle esigenze.
 Fornita con due raggiere da 8/9 petali
 Cake stand with interchangeable petal holder according to
 your request. Endowed with two sets for 8/9 petals

COD. 123

Piatti - Plates:
 Base Ø 70 cm
 petalo/petal 33 x 20 cm
 Porz. - Portions: 80 - 90

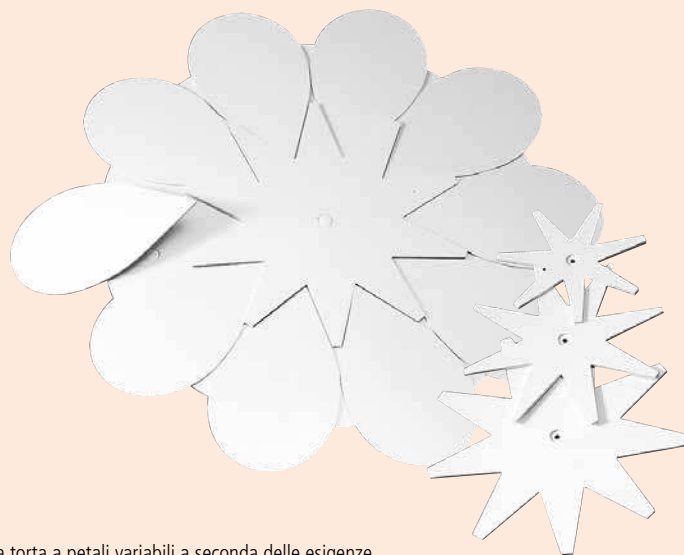

Porta torta a petali variabili a seconda delle esigenze.
 Fornita con quattro raggiere da 7/8/9/10 petali
 Cake stand with interchangeable petal holder according to
 your request. Endowed with four sets for 7/8/9/10 petals

COD. 124

Piatti - Plates:
 Base Ø 90 cm
 petalo/petal 40 x 25 cm
 Porz. - Portions: 115 - 125

È possibile usare singolarmente il cuore intero.
 It is possible to use the whole heart separately.

COD. 126/B

Piatti - Plates:
 85 x 45 cm
 Porz. - Portions: 40 - 45



È possibile usare singolarmente il cuore intero.
 It is possible to use the whole heart separately.

COD. 126/A

Piatti - Plates:
 120 x 65 cm
 Porz. - Portions: 80 - 90

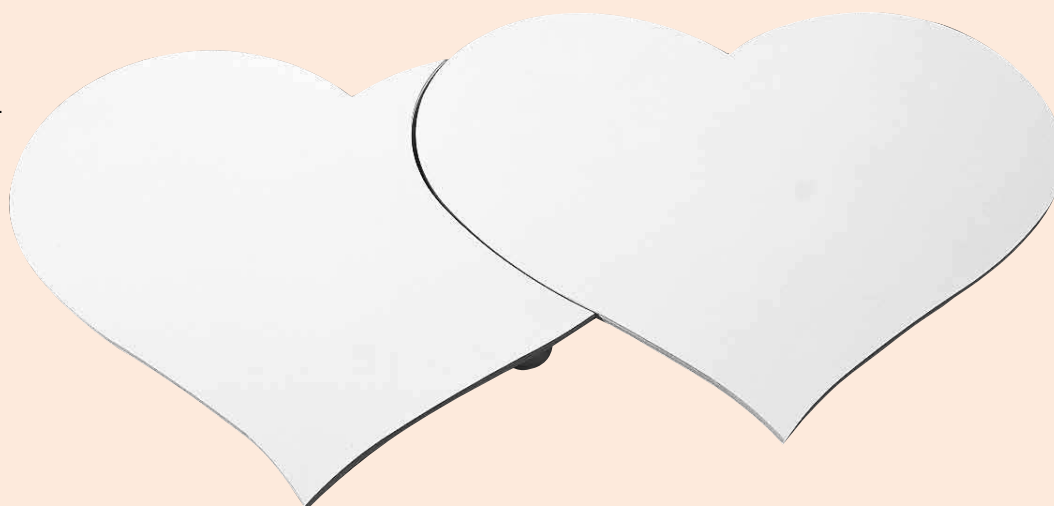

COD. 80-2003

3 piani - levels
 Piatti - Plates:
 Ø 20 - 26 - 32 cm
 Porz. - Portions: 34-36

COD. 80-2004

4 piani - levels
 Piatti - Plates:
 Ø 20 - 26 - 32 - 40 cm
 Porz. - Portions: 60-62

COD. 80-2006

6 piani - levels
 Piatti - Plates:
 Ø 20 - 26 - 32 - 40 - 45 - 50 cm
 Porz. - Portions: 130-132

COD. 80-2008

8 piani - levels
 Piatti - Plates:
 Ø 16 - 20 - 26 - 32 - 40 - 45 - 50 - 55 cm
 Porz. - Portions: 220-225

COD. 80-2005

5 piani - levels
 Piatti - Plates:
 Ø 20 - 26 - 32 - 40 - 45 cm
 Porz. - Portions: 90-92

COD. 80-2007

7 piani - levels
 Piatti - Plates:
 Ø 16 - 20 - 26 - 32 - 40 - 45 - 50 cm
 Porz. - Portions: 175-180

COD. 80-2009

9 piani - levels
 Piatti - Plates:
 Ø 16 - 20 - 26 - 32 - 40 - 45 - 50 - 55 - 60 cm
 Porz. - Portions: 270-280

COD. METAL 3

3 piani - levels
 Piatti - Plates:
 Ø 20 - 26 - 32 cm
 Porz. - Portions: 34-36

COD. METAL 4

4 piani - levels
 Piatti - Plates:
 Ø 20 - 26 - 32 - 40 cm
 Porz. - Portions: 60-62

COD. METAL 6

6 piani - levels
 Piatti - Plates:
 Ø 20 - 26 - 32 - 40 - 45 - 50 cm
 Porz. - Portions: 130-132

COD. METAL 8

8 piani - levels
 Piatti - Plates:
 Ø 16 - 20 - 26 - 32 - 40 - 45 - 50 - 55 cm
 Porz. - Portions: 220-225

COD. METAL 5

5 piani - levels
 Piatti - Plates:
 Ø 20 - 26 - 32 - 40 - 45 cm
 Porz. - Portions: 90-92

COD. METAL 7

7 piani - levels
 Piatti - Plates:
 Ø 16 - 20 - 26 - 32 - 40 - 45 - 50 cm
 Porz. - Portions: 175-180

COD. METAL 9

9 piani - levels
 Piatti - Plates:
 Ø 16 - 20 - 26 - 32 - 40 - 45 - 50 - 55 - 60 cm
 Porz. - Portions: 270-280



POLYSTYRENE CAKE STANDS



Cod. **POLY 10**

Misura - Size: 130 x 80 cm - h 100 cm

Piatti - Plates:

6 piani/levels Ø 25 cm

Porz. - Portions: 70 - 75



Cod. **POLY 11**

Misura - Size: 140 x 80 cm - h 100 cm

Piatti - Plates:

8 piani/levels Ø 22 cm

Porz. - Portions: 60 - 65

Accessori (non inclusi) - Accessories (not included):

FONTANINA



Cod. **POLY 12**

Misura - Size: 130 x 80 cm - h 86 cm

Piatti - Plates:

4 piani/levels Ø 25 cm

1 piano/level 50x26 cm

Porz. - Portions: 90 - 100



Cod. **POLY 14**

Misura - Size: 130 x 80 cm - h 100 cm

Piatti - Plates:

6 piani/levels Ø 22 cm

Porz. - Portions: 60 - 65

Accessori (non inclusi) - Accessories (not included):

FONTANINA



Cod. POLY 19

Misura - Size: 140 x 80 cm - h 98 cm
 Piatti - Plates:
 7 piani/levels Ø 22 cm
 Porz. - Portions: 55 - 60



Cod. POLY 1

Cicogna - Stork
 Misura - Size: 50 x 80 cm - h 75 cm
 Piatti - Plates:
 1 piano/level Ø 30 cm
 Porz. - Portions: 12 - 15



Cod. POLY 6

Coniglietto - Bunny
 Misura - Size: Ø 45 cm - h 70 cm
 Piatti - Plates:
 2 piani/levels Ø 20 cm
 1 piano/level Ø 35 cm
 Porz. - Portions: 24 - 26



Cod. POLY 7

Orsetto - Teddy Bear
 Misura - Size: Ø 45 cm - h 70 cm
 Piatti - Plates:
 2 piani/levels Ø 20 cm
 1 piano/level Ø 35 cm
 Porz. - Portions: 24 - 26

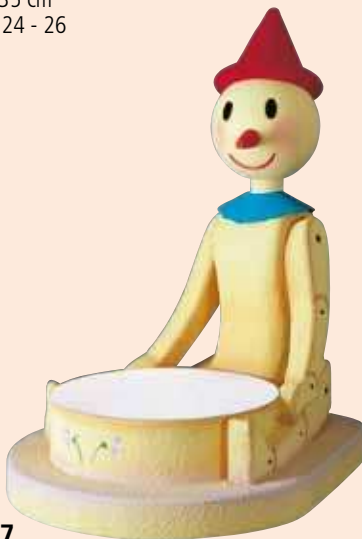

Cod. POLY 17

Pinocchio
 Misura - Size: 45 x 51 cm - h 65 cm
 Piatti - Plates:
 1 piano/level Ø 30 cm
 Porz. - Portions: 12 - 15



Cod. POLY 18

Clown
 Misura - Size: Ø 44 cm - h 51 cm
 Piatti - Plates:
 1 piano/level Ø 30 cm
 Porz. - Portions: 12 - 15



Cod. **JUNIOR01**
Coniglietto - Bunny
Misura - Size: Ø25 h32 cm



Cod. **JUNIOR02**
Orsetto - Bear
Misura - Size: Ø25 h32 cm



Cod. **JUNIOR03**
Clown
Misura - Size: Ø25 h32 cm



Cod. **JUNIOR04**
Pinocchio
Misura - Size: Ø25 h32 cm



Cod. **JUNIOR05**
Coppa - Cup
Misura - Size: Ø25 h32 cm



Cod. **JUNIOR07**
Piedoni - Big Feet
Misura - Size: 47x37 - h12 cm
Piatto - Plate: Ø 30 cm



Cod. **JUNIOR08**
Tartaruga - Turtle
Misura - Size: 55x45 - h20 cm
Piatto - Plate: Ø 30 cm



Cod. **JUNIOR09**
Coccinella - Lady Bug
Misura - Size: 50x42 - h20 cm
Piatto - Plate: Ø 20 cm



Cod. **JUNIOR10**
Polipo - Octopus
Misura - Size: 60x55 - h42 cm
Piatto - Plate: Ø 22 cm

PLASTIC TRAYS

PORTA TORTA IN RESISTENTE MATERIALE PLASTICO

Non assorbe odori ed umidità.

Spessore 8 mm con piedini a sfera Ø 25 mm o senza piedini, tre formati:

rotondo, quadrato, rettangolare.

Altre misure forme realizzabili su richiesta.

STRONG PLASTIC CAKE STAND

Smell and moisture resistant. Thickness 8 mm with or without plastic feet Ø 25 mm 3 models: Round, square, rectangular.

Other shapes and sizes can be produced upon request.



QUADRATA - SQUARE

TAV 50 X 50 C/P	50 x 50 cm	4 piedini - feet
TAV 50 X 50 PIA	50 x 50 cm	senza piedini - whitout feet
TAV 60 X 60 C/P	60 x 60 cm	5 piedini - feet
TAV 60 X 60 PIA	60 x 60 cm	senza piedini - whitout feet
TAV 70 X 70 C/P	70 x 70 cm	9 piedini - feet
TAV 70 X 70 PIA	70 x 70 cm	senza piedini - whitout feet
TAV 80 X 80 C/P	80 x 80 cm	12 piedini - feet
TAV 80 X 80 PIA	80 x 80 cm	senza piedini - whitout feet
TAV 90 X 90 C/P	90 x 90 cm	16 piedini - feet
TAV 90 X 90 PIA	90 x 90 cm	senza piedini - whitout feet

RETTANGOLARE - RECTANGULAR

TAV 40 X 60 C/P	40 x 60 cm	5 piedini - feet
TAV 59X39	59 x 39 cm	senza piedini - whitout feet
TPP 60X40	40 x 60 cm	senza piedini - whitout feet
TAV 50 X 60 C/P	50 x 60 cm	5 piedini - feet
TAV 50 X 60 PIA	50 x 60 cm	senza piedini - whitout feet
TAV 60 X 70 C/P	60 x 70 cm	9 piedini - feet
TAV 60 X 70 PIA	60 x 70 cm	senza piedini - whitout feet
TAV 60 X 80 C/P	60 x 80 cm	12 piedini - feet
TAV 60 X 80 PIA	60 x 80 cm	senza piedini - whitout feet
TAV 70 X 80 C/P	70 x 80 cm	12 piedini - feet
TAV 70 X 80 PIA	70 x 80 cm	senza piedini - whitout feet
TAV 80 X 90 C/P	80 x 90 cm	20 piedini - feet
TAV 80 X 90 PIA	80 x 90 cm	senza piedini - whitout feet
TAV 80 X 100 C/P	80 x 100 cm	20 piedini - feet
TAV 80 X 100 PIA	80 x 100 cm	senza piedini - whitout feet

ROTONDA - ROUND

TAV D. 40 C/P	Ø 40 cm	5 piedini - feet
TAV D. 40 PIA	Ø 40 cm	senza piedini - whitout feet
TAV D. 50 C/P	Ø 50 cm	5 piedini - feet
TAV D. 50 PIA	Ø 50 cm	senza piedini - whitout feet
TAV D. 60 C/P	Ø 60 cm	5 piedini - feet
TAV D. 60 PIA	Ø 60 cm	senza piedini - whitout feet
TAV D. 70 C/P	Ø 70 cm	9 piedini - feet
TAV D. 70 PIA	Ø 70 cm	senza piedini - whitout feet
TAV D. 80 C/P	Ø 80 cm	9 piedini - feet
TAV D. 80 PIA	Ø 80 cm	senza piedini - whitout feet
TAV D. 90 C/P	Ø 90 cm	9 piedini - feet
TAV D. 90 PIA	Ø 90 cm	senza piedini - whitout feet
TAV D. 100 C/P	Ø 100 cm	13 piedini - feet
TAV D. 100 PIA	Ø 100 cm	senza piedini - whitout feet
TAV D. 120 C/P	Ø 120 cm	13 piedini - feet
TAV D. 120 PIA	Ø 120 cm	senza piedini - whitout feet

PLASTIC DUMMIES



COD. 201

Misura - Size: Ø 49 h 58 cm
Piatti - Plates: Ø 49 cm - Ø 33 cm - Ø 17 cm



COD. 202

Misura - Size: 51 x 41 h 58 cm
Piatti - Plates: 51 x 41 cm - 35 x 25,5 cm - 19,5 x 10 cm



COD. 203

Misura - Size: 50 x 41 h 58 cm
Piatti - Plates: 50 x 41 cm - 35 x 25 cm - 19 x 9 cm



COD. 204

Misura - Size: 49 x 49 h 58 cm
Piatti - Plates: 49 x 49 cm - 33 x 33 cm - 17 x 17 cm

HOW TO USE

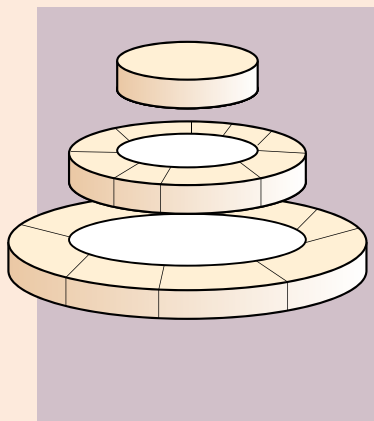

Preparare la base del pan di spagna da sagomare con l'aiuto dei piatti in plastica in dotazione in ogni little wedding cake;

Prepare the sponge cake base to be shaped by using the plastic plates supplied with every Little Wedding Cake;

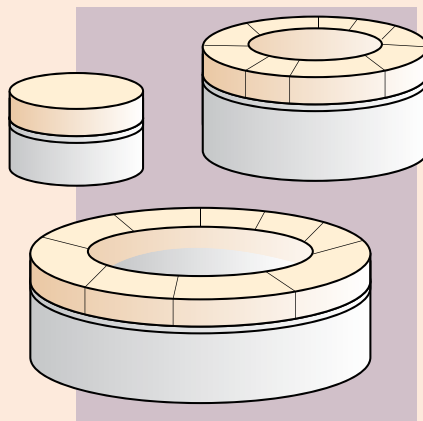

Posizionare su ogni tamburo il pan di spagna e farcire il dolce a piacere avendo cura di non oltrepassare il bordo dei tamburi;

Place the sponge cake on each dummy and finish your cake, taking care not to go beyond the edges of the dummies;

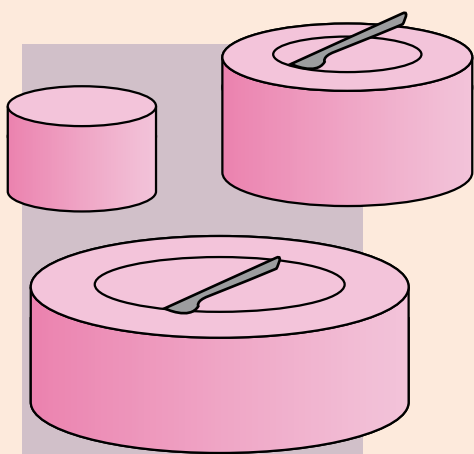

Ricoprire ogni singolo tamburo con la pasta zucchero "Bianco Fondant", forare il centro del primo e del secondo tamburo per rendere possibile l'incastro;

Cover every single dummy with the sugarpaste "Bianco Fondant"; pierce the center of the first and the second dummy to make the assembly possible;

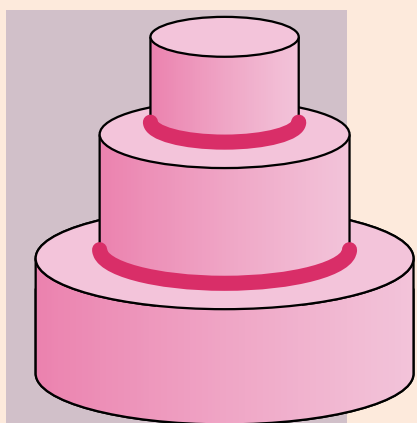

Sovrapporre i tamburi e decorare i bordi per nascondere possibili imperfezioni.;

Overlap the dummies and decorate the edges to hide any possible imperfections.

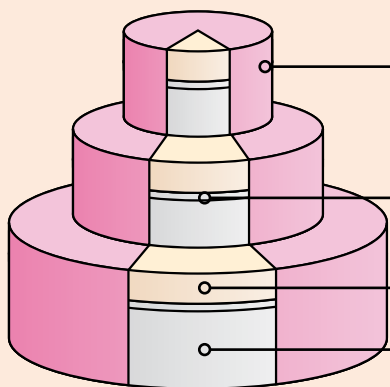

Copertura di pasta zucchero.
Sugarpaste coat

Piatto in plastica
Plastic plate

Dolce / Cake

Tamburi / Dummies

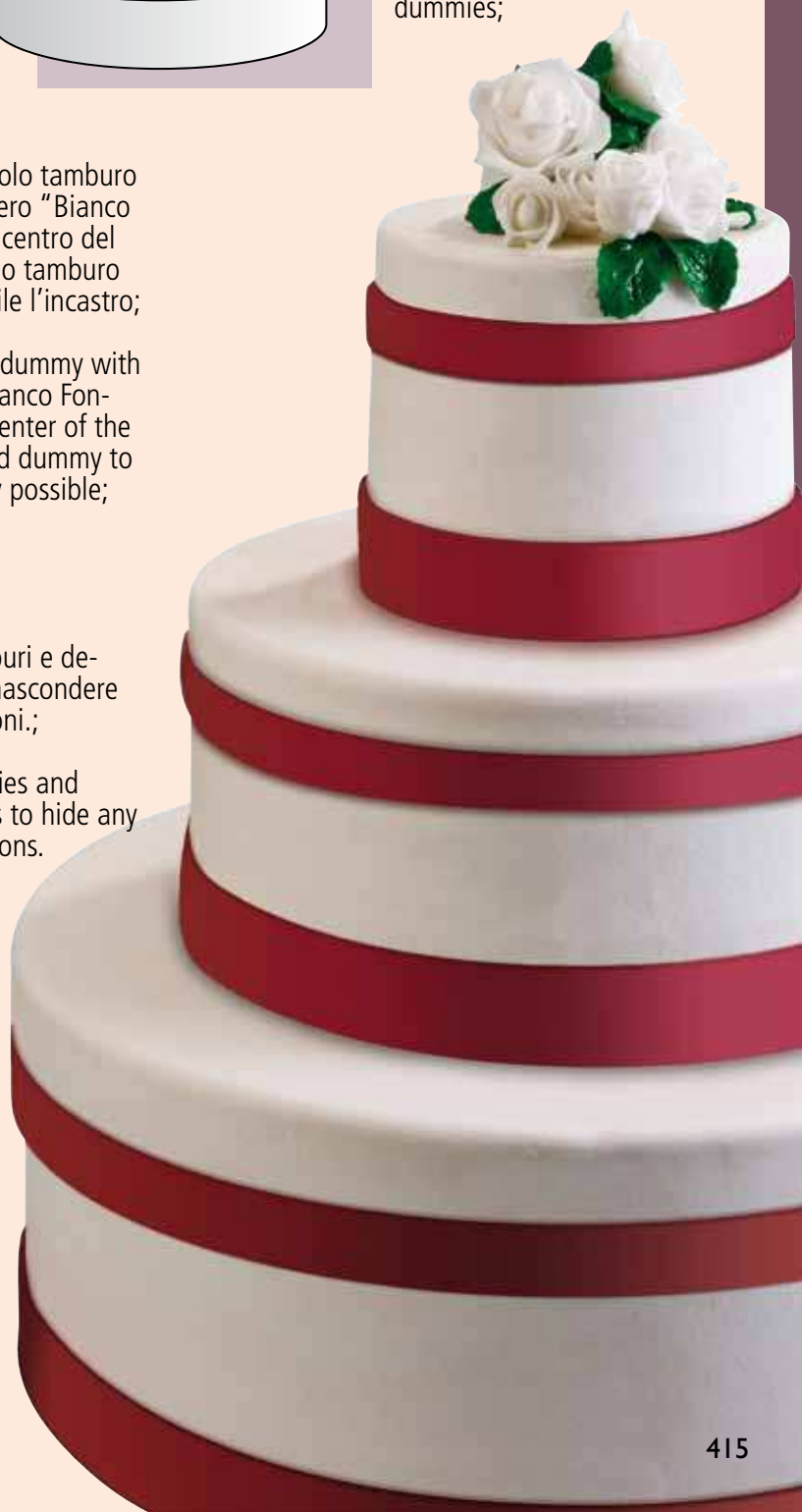

Tamburi in plastica bianca **RIUTILIZZABILI IDONEI AL CONTATTO ALIMENTARE.**

Ideali per realizzare wedding cake di grandi dimensioni. Ogni tamburo è dotato di rinforzo interno dove poter inserire le colonnine necessarie per il montaggio del dolce (40-W101 Ø foro 6 mm).

L'articolo è acquistabile in kit oppure è possibile richiedere separatamente ogni singolo tamburo.

White **REUSABLE** plastic cake dummies **SUITABLE FOR FOOD CONTACT.**

Ideal for creating large wedding cakes. Every cake dummy has internal reinforcement where you insert the columns needed for the assembly of the cake (40-W101 Ø hole 6 mm).

The item can be purchased as a kit or you can request every single cake dummy separately.

Cod. **40-W106**

Set 4 tamburi

Set 4 dummies

Misura - Size:

Ø 50- 40 - 30 - 20 cm



HOW TO USE



Cerchi inox per tamburi St steel rings for dummies

Cod. **40-W087**
Misura - Size: h 5 - Ø19,5 cm

Cod. **40-W088**
Misura - Size: h 5 - Ø29,5 cm

Cod. **40-W089**
Misura - Size: h 5 - Ø39,5 cm

Cod. **40-W090**
Misura - Size: h 5 - Ø49,5 cm

Cod. **40-W110**
Misura - Size: h 10 - Ø20 cm

Cod. **40-W111**
Misura - Size: h 10 - Ø30 cm

Cod. **40-W112**
Misura - Size: h 10 - Ø40 cm

Cod. **40-W113**
Misura - Size: h 10 - Ø50 cm

Tamburi - Dummies



PIATTO ANTISCIVOLO NON-SLIP PLATE

Cod. **40-W124**
Misura - Size: Ø58 cm
Il piatto facilita il trasporto della torta evitando spiacevoli cadute.
The plate makes the transport easier and reduces the risk of damaging the cake.

Colonnine in plastica - Plastic columns

Cod. **40-W101**
Misura - Size: Ø6 mm
Pack 50 pcs



Sottotorta monouso in plastica Disposable plastic cake boards



TONDI - ROUND

40-W056	Ø 16 cm conf. 20 pz
40-W057	Ø 18 cm conf. 20 pz
40-W058	Ø 20 cm conf. 20 pz
40-W059	Ø 22 cm conf. 20 pz
40-W060	Ø 24 cm conf. 20 pz
40-W061	Ø 26 cm conf. 20 pz
40-W062	Ø 28 cm conf. 20 pz
40-W063	Ø 30 cm conf. 20 pz
40-W064	Ø 32 cm conf. 20 pz
40-W208	Ø 34 cm conf. 20 pz
40-W209	Ø 36 cm conf. 20 pz
40-W210	Ø 38 cm conf. 20 pz
40-W065	Ø 40 cm conf. 20 pz

RETTANGOLARI - RECTANGULAR

40-W066	23x33 cm conf. 20 pz
40-W067	25x35 cm conf. 20 pz
40-W068	28x38 cm conf. 20 pz
40-W069	30x40 cm conf. 20 pz
40-W070	32x48 cm conf. 20 pz
40-W071	34x50 cm conf. 20 pz

QUADRATI - SQUARE

40-W072	18x18 cm conf. 20 pz
40-W073	20x20 cm conf. 20 pz
40-W074	23x23 cm conf. 20 pz
40-W075	25x25 cm conf. 20 pz
40-W076	28x28 cm conf. 20 pz
40-W077	30x30 cm conf. 20 pz
40-W078	33x33 cm conf. 20 pz
40-W079	35x35 cm conf. 20 pz
40-W080	38x38 cm conf. 20 pz
40-W081	40x40 cm conf. 20 pz

INDEX OF ITEMS

COD.	PG.	PG.		
23001	stampo cioccolato targhette io+te=amore	40	10SEGC1001-096	segnagusto da appoggio color opale
23002	stampo cioccolato targhette mi piaci	40	10SG00	spatola gelato manico lungo col. trasp.
23003	stampo cioccolato targhette punta in alto	40	10SG01	spatola gelato manico lungo col. bianco
23004	stampo cioccolato targhette keep calm and...	41	10SG02	spatola gelato manico lungo col. lilla
23005	stampo cioccolato targhette sacher	41	10SG03	spatola gelato manico lungo col. rosa
23006	stampo cioccolato targhette for my mom	41	10SG04	spatola gelato manico lungo col. celeste
23007	stampo cioccolato targhette you & me 4ever	41	10SG05	spatola gelato manico lungo col. verde
23008	stampo cioccolato targhette just married	41	10SG06	spatola gelato manico lungo col. gialla
23009	stampo cioccolato targhette i (cuore) you	41	10SG100	spatola gelato manico finto legno
23010	stampo cioccolato targhette auguri frizzanti	41	10SGC00	spatola gelato carapina colore trasparente
23011	stampo cioccolato targhette tiramisù	41	10SGC01	spatola gelato carapina colore bianco
23012	stampo cioccolato targhette limone	41	10SGC02	spatola gelato carapina col. lilla
23013	stampo cioccolato targhette easter	41	10SGC03	spatola gelato carapina col. rosa
23014	stampo cioccolato targhette mimosa	41	10SGC04	spatola gelato carapina col. celeste
23015	stampo cioccolato targhette nocciola	41	10SGC05	spatola gelato carapina col. verde
23016	stampo cioccolato targhette pistacchio	41	10SGC06	spatola gelato carapina col. gialla
23017	stampo cioccolato targhette caffè	41	10SGC100	spatola gelato carapina manico finto legno
23018	stampo cioccolato targhette caprese	41	11H4L24	rettangolo fisso 24x14 cm h 4 cm
23019	stampo cioccolato targhette chocolate	41	11H4L26	rettangolo fisso 26x16 cm h 4 cm
23020	stampo cioccolato targhette chantilly	41	11H4L28	rettangolo fisso 28x18 cm h 4 cm
23021	stampo cioccolato targhette yogurt	41	11H4L30	rettangolo fisso 30x22 cm h 4 cm
23022	stampo cioccolato targhette for my dad	41	11H4L36	rettangolo inox 360x165 mm h 4 cm
23023	stampo cioccolato targhette auguri	41	11H4L38	rettangolo fisso 38x26 cm h 4 cm
23024	stampo cioccolato targhette happy birthday	41	11H4L40	rettangolo fisso 40x30 cm h 4 cm
29001	espositore da banco per soggetti 3d	129	11H5L24	rettangolo fisso 24x14 cm h 5 cm
29002	espositore "arena" lollipops	129	11H5L26	rettangolo fisso 26x16 cm h 5 cm
29003	espositore in plexiglass per lollipop	129	11H5L28	rettangolo fisso 28x18 cm h 5 cm
103000	stampo ice dessert 5 impronte	199	11H5L30	rettangolo fisso 30x22 cm h 5 cm
105000	stampo ghiaccio flex 6 impronte mod. wave conf. 4 pz	187	11H5L36	rettangolo inox 360x165 mm h 5 cm
105001	stampo ghiaccio flex 6 impronte mod. heart conf. 4 pz	187	11H5L38	rettangolo fisso 38x26 cm h 5 cm
105002	stampo ghiaccio flex 6 impronte mod. recouvert conf.4 pz	187	11H5L40	rettangolo fisso 40x30 cm h 5 cm
105003	stampo ghiaccio flex 6 impronte mod. twig conf. 4 pz	187	12H4X10	fiore h 4 cm d. 10 cm
001 OA D	nr.2 pinz. acciaio occhi chiusi	313	12H4X12	fiore h 4 cm d. 12 cm
001 OA L	nr.2 pinz. acciaio occhi aperti	313	12H4X14	fiore h 4 cm d. 14 cm
002 OC D	nr.2 pinz. acciaio occhi chiusi	313	12H4X16	fiore h 4 cm d. 16 cm
002 OC L	nr.2 pinz. acciaio occhi chiusi	313	12H4X18	fiore h 4 cm d. 18 cm
003 VA D	nr.2 pinz. acciaio v aperta	313	12H4X20	fiore h 4 cm d. 20 cm
003 VA L	nr.2 pinz. acciaio v aperta	313	12H4X22	fiore h 4 cm d. 22 cm
004 VC D	nr.2 pinz. acciaio v chiusa	313	12H4X24	fiore h 4 cm d. 24 cm
004 VC L	nr.2 pinz. acciaio v chiusa	313	12H4X26	fiore h 4 cm d. 26 cm
005 CA D	nr.2 pinz. acciaio curva aperta	313	12H4X28	fiore h 4 cm d. 28 cm
005 CA L	nr.2 pinz. acciaio curva aperta	313	12H4X30	fiore h 4 cm d. 30 cm
006 CC D	nr.2 pinz. acciaio curva chiusa	313	12H5X10	fiore h 5 cm d. 10 cm
006 CC L	nr.2 pinz. acciaio curva chiusa	313	12H5X12	fiore h 5 cm d. 12 cm
007 LD D	nr.2 pinz. acciaio linea dritta	313	12H5X14	fiore h 5 cm d. 14 cm
007 LD L	nr.2 pinz. acciaio linea dritta	313	12H5X16	fiore h 5 cm d. 16 cm
008 CU D	nr.2 pinz. acciaio cuore	313	12H5X18	fiore h 5 cm d. 18 cm
008 CU L	nr.2 pinz. acciaio cuore	313	12H5X20	fiore h 5 cm d. 20 cm
009 AG D	nr.2 pinz. acciaio agrifoglio	313	12H5X22	fiore h 5 cm d. 22 cm
009 AG L	nr.2 pinz. acciaio agrifoglio	313	12H5X24	fiore h 5 cm d. 24 cm
010 LO D	nr.2 pinz. acciaio linea ondulata	313	12H5X26	fiore h 5 cm d. 26 cm
010 LO L	nr.2 pinz. acciaio linea ondulata	313	12H5X28	fiore h 5 cm d. 28 cm
10-0078	st. gelato cookie pro d. 78 mm	196	12H5X30	fiore h 5 cm d. 30 cm
10-0083	st. gelato cookie pro d.83 mm	196	13H4X15	stella cometa h 4 cm l. 15 cm
10-1001	gelato flex forma cuore conf. 4 pz.	196	13H4X23	stella cometa h 4 cm l. 23 cm
10-1002	gelato flex recouvert conf. 4 pz.	196	13H4X30	stella cometa h 4 cm l. 30 cm
10-1003	gelato flex twig conf. 4 pz.	196	14H4X16	albero natale h 4 cm l. 16 cm
10-4770	st. gelato cookie pro 47,8x70,2 mm	196	14H4X20	albero natale h 4 cm l. 20 cm
10-4887	st. gelato cookie pro 48x87,5 mm	196	14H4X24	albero di natale h 4 cm l. 24
10-6191	st. gelato cookie pro 61x91 mm	196	14H4X30	albero di natale h 4 cm l. 30
10-6798	st. gelato cookie pro 67x98 mm	196	15H4X25	colomba h 4 cm l. 25 cm
10-E001	espositore cookie pro per vetrina	197	15H4X30	colomba h 4 cm l. 30 cm
10-E002	display gelato flex 24 fori plexiglass	187	15H4X34	colomba h 4 cm l. 34 cm
10-E003	espositore winter ice 165x360mm	185	16H4X18	cuore doppio piccolo 180x105,7 h4 cm
10-E004	espositore winter ice 245x360mm	185	16H4X21	cuore doppio medio 217,5x127,8 h4 cm
10-E005	espositore winter ice da vetrina vertic.	185	16H4X28	cuore doppio grande 280x164,5 h4 cm
10-E015	espositore cookie pro 15 fori	197	16H5X18	cuore doppio piccolo 180x105,7 h5 cm
10-EV008	espositore cookie pro biscotto d. 83 mm	197	16H5X21	cuore doppio medio 217,5x127,8 h5 cm
10-EV010	espositore cookie pro biscotto d. 78 mm	197	16H5X28	cuore doppio grande 280x164,5 h5 cm
10-EV012	espositore cookie pro biscotto d. 83 mm	197	17H4X17	cuore freccia piccolo 175,1x155,5 h4 cm
10-EV015	espositore cookie pro biscotto d. 78 mm	197	17H4X21	cuore freccia medio 218x193,7 h4 cm
10-W001	winter ice mould and cutter	185	17H4X28	cuore freccia grande 280x248,8 h4 cm
10-W010	winter ice mould and cutter	185	17H5X17	cuore freccia piccolo 175,1x155,5 h5 cm
10-W012	winter ice mould and cutter	185	17H5X21	cuore freccia medio 218x193,7 h5 cm
10-W013	winter ice mould and cutter	185	17H5X28	cuore freccia grande 280x248,8 h5 cm
10-W014	winter ice mould and cutter	185	18H4X17	cuore semplice piccolo 175x179,9 h4 cm
10B1001-096	segnagusto da appoggio con inserto	205	18H4X20	cuore semplice medio 200x205,6 h4 cm
10SEG	supporto in plex per segnagusto pack 10 pz	202	18H4X26	cuore semplice grande 260x267,3 h4 cm
10SEG01	kit gusti frutta - modello con foto 30 gusti frutta	202	18H5X17	cuore semplice piccolo 175x179,9 h5 cm
10SEG01EN	kit gusti frutta - modello con foto 30 gusti frutta INGLESE	202	18H5X20	cuore semplice medio 200x205,6 h5 cm
10SEG02	kit gusti creme - modello con foto 30 gusti creme	203	18H5X26	cuore semplice grande 260x267,3 h5 cm
10SEG02EN	kit gusti creme - modello con foto 30 gusti creme INGLESE	203	19H2X25	oblungo curvo 250x60 h 2 cm
10SEG03	kit gusti frutta - modello solo scritta 30 gusti frutta	203	19H2X30	oblungo curvo 300x61 h 2 cm
10SEG04	kit gusti creme - modello solo scritta 30 gusti creme	203	19H4X25	oblungo curvo 250x60 h 4 cm
10SEG051001-096	segnagusto ad immersione 190x85	204	19H4X30	oblungo curvo 300x61 h 4 cm
10SEG101001-096	segnagusto ad immersione 150x70	204	19H5X25	oblungo curvo 250x60 h 5 cm
10SEGB	porta cartellino per segnag. pack 10 pz	205	19H5X30	oblungo curvo 300x61 h 5 cm
			1H2X10	cerchio d. 10 cm h 2 cm
			1H2X12	cerchio d. 12 cm h 2 cm

1H2X14	cerchio d. 14 cm h 2 cm	166
1H2X16	cerchio d. 16 cm h 2 cm	166
1H2X18	cerchio d. 18 cm h 2 cm	166
1H2X20	cerchio d. 20 cm h 2 cm	166
1H2X22	cerchio d. 22 cm h 2 cm	166
1H2X24	cerchio d. 24 cm h 2 cm	166
1H2X26	cerchio d. 26 cm h 2 cm	166
1H2X28	cerchio d. 28 cm h 2 cm	166
1H2X30	cerchio d. 30 cm h 2 cm	166
1H4X10	cerchio d.10 cm h 4 cm	166
1H4X12	cerchio d.12 cm h 4 cm	166
1H4X14	cerchio d.14 cm h 4 cm	166
1H4X16	cerchio d.16 cm h 4 cm	166
1H4X18	cerchio d.18 cm h 4 cm	166
1H4X20	cerchio d. 20 cm h 4 cm	166
1H4X22	cerchio d.22 cm h 4 cm	166
1H4X24	cerchio d. 24 cm h 4 cm	166
1H4X26	cerchio d.26 cm h 4 cm	166
1H4X28	cerchio d.28 cm h 4 cm	166
1H4X30	cerchio d.30 cm h 4 cm	166
1H5X10	cerchio d.10 cm h 5 cm	166
1H5X12	cerchio d.12 cm h 5 cm	166
1H5X14	cerchio d.14 cm h 5 cm	166
1H5X16	cerchio d.16 cm h 5 cm	166
1H5X18	cerchio d.18 cm h 5 cm	166
1H5X20	cerchio d.20 cm h 5 cm	166
1H5X22	cerchio d.22 cm h 5 cm	166
1H5X24	cerchio d.24 cm h 5 cm	166
1H5X26	cerchio d.26 cm h 5 cm	166
1H5X28	cerchio d.28 cm h 5 cm	166
1H5X30	cerchio d.30 cm h 5 cm	166
20-1010	kit stampo fiore di loto grande	64
20-1011	kit stampo fiore di loto piccolo	64
20-3D1001	stampo 3d uovo	26
20-3D1002	stampo 3d uovo	26
20-3D1003	stampo 3d uovo	26
20-3D2001	stampo 3d sfera	26
20-3D2002	stampo 3d sfera	26
20-3D2003	stampo 3d sfera	26
20-3D3001	stampo 3d sfera	26
20-3D4001	stampo 3d sfera	26
20-3D5001	stampo 3d cuore	26
20-3D6001	stampo 3d cuore	26
20-4000	nuova fontana grande per cioccolato	15
20-B001	bastoncini in plastica per lolly pop conf.400 pz	37
20-B002	bastoncini in plastica per lolly pop	37
20-B003	conf. 400 bastoncini cakepops	37
20-C001	chocofunny coniglio con carota	35
20-C002	chocofunny gallo	35
20-C003	chocofunny ovetto con margherite	35
20-C004	chocofunny ovetto con fiori	35
20-C005	chocofunny coniglietto	35
20-C006	chocofunny paperotto	35
20-C007	chocofunny ape	35
20-C008	chocofunny sole	35
20-C009	chocofunny farfalla	35
20-C010	chocofunny farfalla ali aperte	35
20-C011	chocofunny farfalla ali chiuse	35
20-C012	chocofunny ape	35
20-C013	chocofunny fiore	35
20-C014	chocofunny cuori misti	35
20-C015	chocofunny cuore	35
20-C016	chocofunny cuore	35
20-C017	chocofunny lollypop animali domestici	36
20-C018	chocofunny lettere a-i	35
20-C019	chocofunny lettere j-r	35
20-C020	chocofunny lettere s-z	35
20-C021	chocofunny numeri grandi 0-4	35
20-C022	chocofunny numeri grandi 5-9	35
20-C023	chocofunny numeri piccoli 0-9	35
20-C024	chocofunny lollypop natale	36
20-C1000	stampo polic. 3d alberello	44
20-C1001	stampo polic. 3d renna grande	44
20-C1002	stampo polic. 3d renna piccola	44
20-C1003	stampo polic. 3d scoiattoli grandi	44
20-C1004	stampo polic. 3d scoiattoli medi	44
20-C1005	stampo polic. 3d scoiattoli piccoli	44
20-C1006	stampo polic. 3d elefanti grandi	45
20-C1007	stampo polic. 3d elefanti medi	45
20-C1008	stampo polic. 3d elefanti piccoli	45
20-C1009	stampo albero natale + candela	43
20-C1010	stampo babbo natale + pupazzo di neve	43
20-C1011	stampo halloween gatto e zucca	43
20-C1955	stampo polic. calamita gallo	45
20-C1956	stampo polic. calamita gallina	45
20-C1957	stampo polic. calamita pulcini	45
20-CA001	stampo cioccolato maschera	63
20-CA002	stampo cioccolato maschera	63
20-CA003	stampo cioccolato maschera	63
20-CA004	stampo cioccolato maschera	63
20-CA005	stampo cioccolato maschera	63
20-CA006	stampo cioccolato maschera	63
20-CA007	stampo cioccolato maschera	63
20-CA008	stampo cioccolato maschera	63
20-CA009	stampo cioccolato maschera	63
20-CA010	stampo cioccolato maschera	63
20-CA011	stampo cioccolato maschera	63
20-CA012	stampo cioccolato maschera	63
20-CA100	stampo cioccolato pallone da calcio	65
20-CU001	conf. 3 pz stampi per supporto uovo	61
20-D001 / 20-D027	stampo policarbonato decorazione	30-33
20-R4000	anello satinato per fontana 20-4000	15
20-S001	sacchetti per lolly pop conf. 400 pz	37

20-S002	sacchetti per lolly pop	37
20-S003	sacchetti per lolly pop	37
20-S1010	scenette di natale kit 3 pz	72
20-S2010	scenette di pasqua kit 3 pz	72
20-U1010	stampo uovo sezionato piccolo 1 pz	59
20-U1011	stampo uovo sezionato grande 2 pz	59
20EC01	kit 6 stampi cioccolato deco eclair	183
20EC02	kit 6 stampi cioccolato deco mini eclair	183
20GU001	stampo guscio cono trasparente	23
20GU002	stampo guscio coppette trasparente	23
20GU003	stampo polic. minichocofill bicchierino 24 pcs	23
20GU004	stampo polic. minichocofill bicchierino 24 pcs	23
20GU005	stampo polic. minichocofill tazzina 24 pcs	22
20GU500	stampo polic. tazza caffè' 12pcs	22
20H2X16	oblungo stretto 160x60 h2 cm	168
20H2X21	oblungo stretto 211x61 h2 cm	168
20H2X26	oblungo stretto 262x62 h2 cm	168
20H2X31	oblungo stretto 313x63 h2 cm	168
20H4X16	oblungo stretto 160x60 h4 cm	168
20H4X21	oblungo stretto 211x61 h4 cm	168
20H4X26	oblungo stretto 262x62 h4 cm	168
20H4X31	oblungo stretto 313x63 h4 cm	168
20H5X16	oblungo stretto 160x60 h5 cm	168
20H5X21	oblungo stretto 211x61 h5 cm	168
20H5X26	oblungo stretto 262x62 h5 cm	168
20H5X31	oblungo stretto 313x63 h5 cm	168
20L001	stampo lolly pop tavoletta ovetto	39
20L002	stampo lolly pop tavoletta tondo	39
20L003	stampo lolly pop tavoletta rettangolare	39
20TEC1K	conf. 4 pz stampi cioccolato decoro cilindro	149
20TES001	stampo decoro cioccolato per texture arabic conf. 2pz	142
20TES002	stampo decoro cioccolato per texture floreal conf. 2pz	142
20TES003	stampo decoro cioccolato per texture o'clock conf. 2pz	142
20TES004	stampo decoro cioccolato per texture flower conf. 2pz	142
20TES005	stampo decoro cioccolato per texture medieval conf. 2pz	142
20TES006	stampo decoro cioccolato per texture stone conf. 2pz	142
20TES007	stampo decoro cioccolato per texture waves conf. 2pz	142
20U032	stampo polic. ovetto 32,5x22,5 gr 10	60
20U032A	stampo polic. ovetto 32,5x22,5 gr 10 c/attacchi	61
20U065	stampo polic. uovo 65x45 gr20	60
20U065A	stampo polic. uovo 65x45 gr20 c/attacchi	61
20U170	stampo polic. uovo 170x108 gr 175	60
20U170A	stampo polic. uovo 170x108 gr 175con attacchi	61
20U205	stampo polic. uovo 205x135 gr250	60
20U205A	stampo polic. uovo 205x135 gr 250 c/attacchi	61
20U230	stampo polic. uovo 230x163 gr 350	60
20U230A	stampo polic. uovo 230x163 gr 350 c/attacchi	61
20U258	stampo polic. uovo 258x175 gr 500	60
20U258A	stampo polic. uovo 258x175 gr 500 c/attacchi	61
20U320	stampo polic. uovo 320x210 gr 850	60
20U320A	stampo polic. uovo 320x210 gr 850 con attacchi	61
20UG01	gancio 24 mm colore blu conf. 4 pz	60
20UG02	gancio 22 mm colore trasparente conf. 4 pz	60
21-16161	vassoio orientale nero conf 5 pz	377
21-16162	vassoio orientale nero conf 5 pz	377
21-16163	vassoio orientale nero conf 5 pz	377
21-18651	vassoio orientale nero conf 5 pz	377
21-18652	vassoio orientale nero conf 5 pz	377
21-18653	vassoio orientale nero conf 5 pz	377
21-24701	vassoio orientale nero conf 5 pz	377
21-24702	vassoio orientale nero conf 5 pz	377
21-24703	vassoio orientale nero conf 5 pz	377
21-33161	vassoio orientale nero conf 5 pz	377
21-33162	vassoio orientale nero conf 5 pz	377
21-33163	vassoio orientale nero conf 5 pz	377
21-35241	vassoio orientale nero conf 5 pz	377
21-35242	vassoio orientale nero conf 5 pz	377
21-35243	vassoio orientale nero conf 5 pz	377
21-35781	vassoio orientale nero conf 5 pz	377
21-35782	vassoio orientale nero conf 5 pz	377
21-35783	vassoio orientale nero conf 5 pz	377
21H2X20	oblungo largo 200x100 h2 cm	171
21H2X25	oblungo largo 251x101 h2 cm	171
21H2X30	oblungo largo 302x102 h2 cm	171
21H2X35	oblungo largo 353x103 h2 cm	171
21H4X20	oblungo largo 200x100 h4 cm	171
21H4X25	oblungo largo 251x101 h4 cm	171
21H4X30	oblungo largo 302x102 h4 cm	171
21H4X35	oblungo largo 353x103 h4 cm	171
21H5X20	oblungo largo 200x100 h5 cm	171
21H5X25	oblungo largo 251x101 h5 cm	171
21H5X30	oblungo largo 302x102 h5 cm	171
21H5X35	oblungo largo 353x103 h5 cm	171
21VA085	vasetto piccolo svasato per uovo	61
21VA102	vasetto grande per uovo	61
22BOX48	martbox base 48x48 bobina 15 mt	131
22BOX48T1	conf 100 tappi per bobina base 48x48mm - beige/fantasia	131
22BOX48T2	conf 100 tappi per bobina base 48x48mm - verde/marrone	131
22BOX48T3	conf 100 tappi per bobina base 48x48mm - rosso/righe	131
22BOX60	martbox base 60x60 bobina 15 mt	131
22BOX60T1	conf 100 tappi per bobina base 60x60mm - beige/fantasia	131
22BOX60T2	conf 100 tappi per bobina base 60x60mm - verde/marrone	131
22BOX60T3	conf 100 tappi per bobina base 60x60mm - rosso/righe	131
22BOX85	martbox base 85x85 bobina 15 mt	131
22BOX85T1	conf 100 tappi per bobina base 85x85mm - beige/fantasia	131
22BOX85T2	conf 100 tappi per bobina base 85x85mm - verde/marrone	131
22BOX85T3	conf 100 tappi per bobina base 85x85mm - rosso/righe	131
22H4X23	oblungo sagomato 239x99 h4 cm	168
22H4X36	oblungo sagomato 360x100 h4 cm	168
22H5X23	oblungo sagomato 239x99 h5 cm	168
22H5X36	oblungo sagomato 360x100 h5 cm	168
23H2X25	rettangolare 250x90 h2 cm	168

23H2X30	rettangolare 300x91 h2 cm	168	30SM039	pinguino innamorato 55x45 h80mm	99
23H2X35	rettangolare 350x92 h2 cm	168	30SM040	pinguini in love 85x50 h80mm	99
23H4X25	rettangolare 250x90 h4 cm	168	30SM041	coccinella felice 60x40 h100mm	108
23H4X30	rettangolare 300x91 h4 cm	168	30SM042	coccinella stesa 55x80 h85mm	109
23H4X35	rettangolare 350x92 h4 cm	168	30SM043	pergamena comunione 150x100 h25mm	103
23H5X25	rettangolare 250x90 h5 cm	168	30SM044	calciatore 62x35 h105mm	113
23H5X30	rettangolare 300x91 h5 cm	168	30SM045	stampo macchina da cucire vintage	111
23H5X35	rettangolare 350x92 h5 cm	168	30SM046	stampo macchina fotografica vintage	111
24H4X15	quadro fancy lato 150 h4 cm	169	30SM047	stampo civetta laureato	103
24H4X20	quadro fancy lato 200 h4 cm	169	30SM048	stampo clown	123
24H4X25	quadro fancy lato 250 h4 cm	169	30SM049	stampo cofanetto bocciolo di rosa	100
24H5X15	quadro fancy lato 150 h5 cm	169	30SM050	stampo cofanetto cuore con rose	101
24H5X20	quadro fancy lato 200 h5 cm	169	30SM051	stampo valigia	111
24H5X25	quadro fancy lato 250 h5 cm	169	30SM052	stampo maschera carnevale grande	123
25H4X15	quadro bordi arrotondati lato 150 h4 cm	169	30SM053	stampo maschera carnevale piccola	123
25H4X20	quadro bordi arrotondati lato 200 h4 cm	169	30SM054	scarpa sneakers	113
25H4X25	quadro bordi arrotondati lato 250 h4 cm	169	30SM055	stampo bimbo con palla di neve	115
25H5X15	quadro bordi arrotondati lato 150 h5 cm	169	30SM056	stampo bimbo eschimese	115
25H5X20	quadro bordi arrotondati lato 200 h5 cm	169	30SM057	stampo bimbo eschimese	115
25H5X25	quadro bordi arrotondati lato 250 h5 cm	169	30SM058	stampo angioletto con stella	93
26H4X14	zucca 146x114 h4 cm	172	30SM059	stampo funghetti nel bosco	117
26H4X15	zucca 148x132 h4 cm	172	30SM060	stampo trio funghi	117
26H4X23	zucca 237x225 h4 cm	172	30SM061	stampo mini gufo di halloween	91
27H4X12	uovo 121x180 h4cm	173	30SM062	stampo mini zucchetto di halloween	91
27H4X13	uovo 134x200 h4cm	173	30SM063	stampo mini stregghetta di halloween	91
27H4X14	uovo 148x220 h4cm	173	30SM064	stampo mini fantasma di halloween	91
27H4X16	uovo 161x240 h4cm	173	30SM065	stampo gatto mini fattoria	119
28H4X15	campana con fiocco 158x200 h4 cm	173	30SM066	stampo cane mini fattoria	119
28H4X18	campana con fiocco 181x230 h4 cm	173	30SM067	stampo mucca mini fattoria	119
28H4X20	campana con fiocco 205x260 h4 cm	173	30SM068	stampo maiale mini fattoria	119
29H4X09	coniglio 98x200 h4 cm	173	30SM069	stampo trattore	119
29H4X11	coniglio 112x230 h4 cm	173	30SM070	stampi bara con scheletro halloween	89
29H4X12	coniglio 127x260 h4 cm	173	30SM071	stampo vespa vintage	110
2H4X10	ovale d.10 cm h 4 cm	166	30SM072	stampo gesu bambino	94
2H4X12	ovale d.12 cm h 4 cm	166	30SM073	stampo san giuseppe	94
2H4X14	ovale d.14 cm h 4 cm	166	30SM074	stampo maria	94
2H4X16	ovale d.16 cm h 4 cm	166	30SM075	stampo bue	94
2H4X18	ovale d.18 cm h 4 cm	166	30SM076	stampo asinello	94
2H4X20	ovale d.20 cm h 4 cm	166	30SM077	nativita' set 5 pz	95
2H4X22	ovale d.22 cm h 4 cm	166	30SM078	stampo amico del bosco	117
2H4X24	ovale d.24 cm h 4 cm	166	30SM079	stampo mini candela di natale	97
2H4X26	ovale d.26 cm h 4 cm	166	30SM080	stampo mini babbo nel camino	97
2H4X28	ovale d.28 cm h 4 cm	166	30SM081	stampo mini calza befana	97
2H4X30	ovale d.30 cm h 4 cm	166	30SM082	stampo mini pupazzo di neve	97
2H5X10	ovale d.10 cm h 5 cm	166	30SM083	stampo scarpa uomo	113
2H5X12	ovale d.12 cm h 5 cm	166	30SM084	stampo scarpa donna	113
2H5X14	ovale d.14 cm h 5 cm	166	30SM085	stampo bimbo su conchiglia	104
2H5X16	ovale d.16 cm h 5 cm	166	30SM086	stampo teschio halloween	89
2H5X18	ovale d.18 cm h 5 cm	166	30SM087	stampo angelo con cometa	93
2H5X20	ovale d.20 cm h 5 cm	166	30SMA001	stampo gingillo quadretto angelo mod. 1	96
2H5X22	ovale d.22 cm h 5 cm	166	30SMA002	stampo gingillo quadretto angelo mod. 2	96
2H5X24	ovale d.24 cm h 5 cm	166	30SMA003	stampo gingillo quadretto angelo mod. 3	96
2H5X26	ovale d.26 cm h 5 cm	166	30SMA004	stampo gingillo quadretto angelo mod. 4	96
2H5X28	ovale d.28 cm h 5 cm	166	30SMA005	stampo gingillo quadretto angelo mod. 5	96
2H5X30	ovale d.30 cm h 5 cm	166	30SMA006	stampo gingillo quadretto angelo mod. 6	96
30H4X01	numero uno 200 cm h 4 cm	171	30SMA007	stampo campana 3d angelo con cuore	96
30H4X02	numero due 200 cm h 4 cm	171	30SMA008	stampo campana 3d angelo con croce	96
30H4X03	numero tre 200 cm h 4 cm	171	30SMA009	stampo gingillo fiocco pupazzo di neve	96
30H4X04	numero quattro 200 cm h 4 cm	171	30SMA010	stampo gingillo alberello con pinguino	96
30H4X05	numero cinque 200 cm h 4 cm	171	30SMA011	stampo gingillo quadretto babbo natale	96
30H4X06	numero sei 200 cm h4 cm	171	30SMA012	stampo gingillo campana con renna	96
30H4X07	numero sette 200 cm h 4 cm	171	30SMF01	foglia ovata 01 - 90x67mm	126
30H4X08	numero otto 200 cm h 4 cm	171	30SMF02	foglia ovata 02 - 85x57mm	126
30H4X09	numero nove 200 cm h 4 cm	171	30SMF03	foglia ellittica 01 - 117x57mm	126
30H4X10	numero zero 200 cm h 4 cm	171	30SML001	lolly pop halloween	91
30SM001	stampo silicone renna con cuore	92	30SML002	lolly pop natale	97
30SM002	stampo silicone orsetto babbo natale	92	30SML003	lolly pop san valentino	99
30SM003	stampo silicone babbo natale	92	30SMT01	kit stampo + vassoio qusci macarons	127
30SM004	stampo silicone pupazzo di neve con lanterna	92	30SMTPO1	tappeto piece sposi con cuori mod. 1	124
30SM005	stampo silicone gufo	118	30SMTPO2	tappeto piece sposi con cuori mod. 2	124
30SM006	stampo silicone scoiattolo	118	30SMTPO3	tappeto piece colombe e cuori	124
30SM007	stampo silicone babbo natale gnomo	92	30SMW01	sposi stilizzati grandi 80x35 h140mm	107
30SM008	stampo silicone pupazzo di neve con sciarpa	93	30SMW02	sposi stilizzati piccoli 45x35 h120mm	107
30SM009	stampo silicone renna simpatica	93	30SMW03	sposi in auto 145x80 h120mm	107
30SM010	stampo silicone angioletto con libro	93	30SMW04	targa sposi just married 115x127 h20mm	107
30SM011	stampo silicone bebe che dorme	104	30SP0100	stampo pandoro in alluminio 100gr	178
30SM012	stampo in silicone cuscino	104	30SP0250	stampo pandoro in alluminio 250gr	178
30SM013	stampo silicone scheletro con mantello	90	30SP0500	stampo pandoro in alluminio 500gr	178
30SM014	stampo in silicone zucca con gatto	90	30SP1000	stampo pandoro in alluminio 1000 gr	178
30SM015	stampo in silicone dracula	90	30T01K	starter kit arabic (teglia+tappeti+decori)	145
30SM016	stampo in silicone frankenstein	90	30T02K	starter kit floreal (teglia+tappeti+decori)	145
30SM017	stampo in silicone presepe	95	30T03K	starter kit o'clock (teglia+tappeti+decori)	145
30SM018	stampo silicone angelo con cornetta	93	30T04K	starter kit flower (teglia+tappeti+decori)	145
30SM019	stampo silicone vampiro	90	30T05K	starter kit medieval (teglia+tappeti+decori)	145
30SM020	pecora con vestito a fiori 80x65 h110mm	120	30T06K	starter kit stone (teglia+tappeti+decori)	145
30SM021	pecora con maglietta 80x60 h115mm	120	30T07K	starter kit waves (teglia+tappeti+decori)	145
30SM022	coniglio con carriola 105x55 h120mm	122	30T604005	tappeto in silicone 60x40 medievale	139
30SM023	coniglio con carota100x80 h140mm	122	30T604006	tappeto in silicone 60x40 stone	139
30SM024	gallina con uovo verticale 85x75 h125mm	122	30T604007	tappeto in silicone 60x40 waves	139
30SM025	gallina con uovo orizzontale 100x77 h125mm	122	30T604011	tappeto in silicone 60x40 effetto legno	140
30SM026	coniglio con uovo pasquale 77x80 h120mm	122	30T604012	tappeto in silicone 60x40 mattoni irregolari	140
30SM027	coniglio con ovetto 55x65 h110mm	122	30T604013	tappeto in silicone 60x40 stella cometa	140
30SM028	big pecora con fiore 80x75 h130mm	120	30T604014	tappeto in silicone 60x40 fiori e farfalle	140
30SM029	pecora con salopette 75x60 h125mm	120	30T604015	tappeto in silicone 60x40 fiorellini	140
30SM030	mamma pecora con bebe' 70x70 h125mm	120	30T604016	tappeto in silicone 60x40 quadri	140
30SM031	ippo pippo l'ippopotamo 80x65 h95mm	118	30T604017	tappeto in silicone 60x40 fiori e ricci	140
30SM032	topolino con cravatta 57x55 h90mm	109	30T604018	tappeto in silicone 60x40 margherite	140
30SM033	cicogna con bebe' 120x75 h115mm	104	30TB35	conf. 2 stampi inserto cilindrico 3 sedi	144
30SM034	riccio 65x70 h70mm	117	30TB45	kit teglia+4 inserti in silicone	149
30SM035	elefante 110x70 h120mm	118	30TC0016	conf. 6 cilindri 360° + estrattore	148
30SM036	orsetto con ciuccio 65x60 h80mm	104	30TC001K	starter kit stampo cilindro	147
30SM037	pergamena cresima 100x150 h25mm	103	30TCDECO1K	conf. 8 pz decori per cilindro	148
30SM038	libro 145x100 h20mm	103	30TE6001R	tappeto 60x40 eclair grande	183

30TE6002R	tappeto 60x40 mini eclair	183	40-WC305	polvere lacca marrone 5 gr af	297
30TM3001R	tappeto macarons 30x40 color rosso mattone	181	40-WC306	polvere nero blu 5 gr af	297
30TM6001R	tappeto macarons 60x40 color rosso mattone	181	40-WC307	polvere lacca rosa 5 gr af	297
30TS001	tappeto silicone texture arabic 30x20 cm	139	40-WC308	polvere lacca rossa 5 gr af	297
30TS002	tappeto silicone texture floreal 30x20 cm	139	40-WC309	polvere lacca verde 5 gr af	297
30TS003	tappeto silicone texture o'clock 30x20 cm	139	40-WC310	polvere lacca viola 5 gr af	297
30TS004	tappeto silicone texture flower 30x20 cm	139	40-WC311	polvere lacca arancio 5 gr af	297
30TS005	tappeto silicone texture medieval 30x20 cm	139	40-WC322	polvere lacca candy pink 5 gr af	297
30TS006	tappeto silicone texture stone 30x20 cm	139	40-WC600	colorante per aerografo bianco 45 ml a	295
30TS007	tappeto silicone texture waves 30x20 cm	139	40-WC601	colorante per aerografo arancio 45 ml a	295
30TS008	tappeto silicone texture holly 359x163 cm	139	40-WC602	colorante per aerografo blu 45 ml a	295
30TS009	tappeto silicone texture snowflake 359x163 cm	139	40-WC603	colorante per aerografo azzurro 45 ml a	295
30TS010	tappeto silicone texture comet 359x163 cm	140	40-WC604	colorante per aerografo giallo 45 ml a	295
30TS011	tappeto in silicone 36x16,5 texture tronco	140	40-WC605	colorante per aerografo marrone 45 ml a	295
30TS012	tappeto in silicone 36x16,5 mattone regolare	140	40-WC606	colorante per aerografo nero 45 ml a	295
30TS013	tappeto in silicone 36x16,5 stella cometa	140	40-WC607	colorante per aerografo rosa 45 ml a	295
30TS014	tappeto in silicone 36x16,5 farfalle e fiori	140	40-WC608	colorante per aerografo rosso 45 ml a	295
30TS015	tappeto in silicone 36x16,5 fiorellini	140	40-WC609	colorante per aerografo verde 45 ml a	295
30TS016	tappeto in silicone 36x16,5 quadri	140	40-WC610	colorante per aerografo viola 45 ml a	295
30TS017	tappeto in silicone 36x16,5 fiori e ricci	140	40-WC611	colorante per aerog. giallo lim.45 ml a	295
30TS018	tappeto in silicone 36x16,5 margherite	140	40-WC612	colorante per aerog. pistacchio 40 ml a	295
30TT3025	teglia per tronchi 30x40 cm 2 sedi	144	40-WC617	colorante per aerog oro pearl45 ml a	295
30TT6055	teglia per tronchi 40x60 cm 5 sedi	144	40-WC619	colorante per aerog. argento 45 a	295
31CUT01	taglia pasta per pasta mandorle eclair	183	40-WCA301	colorante per aerografo mat arancio 40 ml	294
31CUT02	taglia pasta per pasta mandorle mini eclair	183	40-WCA303	colorante per aerografo mat sky blue 40 ml	294
31H4X11	forma inox fetta torta 117x61 mm h4	173	40-WCA304	colorante per aerografo mat giallo 40 ml	294
31H5X11	forma inox fetta torta 117x61 mm h5	173	40-WCA306	colorante per aerografo mat nero 40 ml	294
3H4X10	esagono lato 10 cm h 4 cm	167	40-WCA308	colorante per aerografo mat rosso 40 ml	294
3H4X11	esagono lato 11 cm h 4 cm	167	40-WCA326	colorante per aerografo mat verde lime 40 ml	294
3H4X12	esagono lato 12 cm h 4 cm	167	40-WCA417	colorante per aerografo oro 40 ml	294
3H4X13	esagono lato 13 cm h 4 cm	167	40-WCA419	colorante per aerografo argento 40 ml	294
3H4X14	esagono lato 14 cm h 4 cm	167	40-WCB200	cocoa butter bianco 30 gr	298
3H4X5	esagono lato 5 cm h 4 cm	167	40-WCB201	cocoa butter arancio 30 gr	298
3H4X6	esagono lato 6 cm h 4 cm	167	40-WCB202	cocoa butter blu 30 gr	298
3H4X7	esagono lato 7 cm h 4 cm	167	40-WCB204	cocoa butter giallo 30 gr	298
3H4X8	esagono lato 8 cm h 4 cm	167	40-WCB206	cocoa butter nero 30 gr	298
3H4X9	esagono lato 9 cm h 4 cm	167	40-WCB208	cocoa butter rosso 30 gr	298
3H5X10	esagono lato 10 cm h 5 cm	167	40-WCB210	cocoa butter viola 30 gr	298
3H5X11	esagono lato 11 cm h 5 cm	167	40-WCB217	cocoa butter oro 30 gr	298
3H5X12	esagono lato 12 cm h 5 cm	167	40-WCP508	polvere interferenziale rossa met. 5 gr	296
3H5X13	esagono lato 13 cm h 5 cm	167	40-WCP517	polvere interferenziale oro met. 5 gr	296
3H5X14	esagono lato 14 cm h 5 cm	167	4H4X10	triangolo lato 10 cm h 4 cm	167
3H5X5	esagono lato 5 cm h 5 cm	167	4H4X12	triangolo lato 12 cm h 4 cm	167
3H5X6	esagono lato 6 cm h 5 cm	167	4H4X14	triangolo lato 14 cm h 4 cm	167
3H5X7	esagono lato 7 cm h 5 cm	167	4H4X16	triangolo lato 16 cm h 4 cm	167
3H5X8	esagono lato 8 cm h 5 cm	167	4H4X18	triangolo lato 18 cm h 4 cm	167
3H5X9	esagono lato 9 cm h 5 cm	167	4H4X20	triangolo lato 20 cm h 4 cm	167
40-W021	mattarello diam. 25 l. 230 mm	270	4H4X23	triangolo lato 23 cm h 4 cm	167
40-W022	mattarello diam. 45 l. 500 mm	270	4H4X25	triangolo lato 25 cm h 4 cm	167
40-W056	dischi sottotorta d. 16	417	4H5X10	triangolo lato 10 cm h 5 cm	167
40-W057	dischi sottotorta d. 18	417	4H5X12	triangolo lato 10 cm h 5 cm	167
40-W058	dischi sottotorta d. 20	417	4H5X14	triangolo lato 10 cm h 5 cm	167
40-W059	dischi sottotorta d. 22	417	4H5X16	triangolo lato 16 cm h 5 cm	167
40-W060	dischi sottotorta d. 24	417	4H5X18	triangolo lato 18 cm h 5 cm	167
40-W061	dischi sottotorta d. 26	417	4H5X20	triangolo lato 20 cm h 5 cm	167
40-W062	dischi sottotorta d. 28	417	4H5X23	triangolo lato 23 cm h 5 cm	167
40-W063	dischi sottotorta d. 30	417	4H5X25	triangolo lato 25 cm h 5 cm	167
40-W064	dischi sottotorta d. 32	417	50-0030	orange poche sacchetti 100 pz h 30	223
40-W065	dischi sottotorta d. 40	417	50-0040	orange poche sacchetti 100 pz h 40	223
40-W066	sottotorta rett. 23x33	417	50-0055	orange poche sacchetti 100 pz h 55	223
40-W067	sottotorta rett. 25x35	417	50-0065	orange poche sacchetti 100 pz h 65	223
40-W068	sottotorta rett. 28x38	417	50-1030	green poche sacchetti h 30 in rotolo 100 pz	222
40-W069	sottotorta rett. 30x40	417	50-1040	green poche sacchetti h 40 in rotolo 100 pz	222
40-W070	sottotorta rett. 32x48	417	50-1055	green poche sacchetti h55 in rotolo 100 pz	222
40-W071	sottotorta rett. 34x50	417	50-1065	green poche sacchetti h 65 in rotolo 100 pz	222
40-W072	sottotorta 18x18 cm	417	50-C015	telaio per chitarra 15 mm	214
40-W073	sottotorta 20x20 cm	417	50-C022	telaio per chitarra 22,5 mm	214
40-W074	sottotorta 23x23 cm	417	50-C030	telaio per chitarra 30 mm	214
40-W075	sottotorta 25x25 cm	417	50-C045	telaio per chitarra 45 mm	214
40-W076	sottotorta 28x28 cm	417	50-CD100N	base per chitarra doppia nuova	215
40-W077	sottotorta 30x30 cm	417	50-CS100	base chitarra singola	214
40-W078	sottotorta 33x33 cm	417	50AD001	adattatore piccolo per bocchette	229
40-W079	sottotorta 35x35 cm	417	50AD002	adattatore medio per bocchette	229
40-W080	sottotorta 38x38 cm	417	50AD003	adattatore grande per bocchette	229
40-W081	sottotorta 40x40 cm	417	50CA382830	cassa universale c/ coperchio 38x28 h30 20 litri col. trasparente	352
40-W083	tappeto 60x40 cm decoro farfalle	417	50CA382830B	cassa universale c/ coperchio 38x28 h30 20 litri col. bianco	352
40-W084	tappeto 60x40 cm decoro fiore fantasia	417	50CA50COP	coperchio per cassa da 50 litri	353
40-W085	tappeto 60x40 cm decoro quadri	417	50CA5543C	cassa milleusi 55x43 h31 50 litri	353
40-W086	tappeto 60x40 cm decoro cerchi	417	50CA5543F	cassa forata 55x43 h31 50 litri	353
40-W087	forma inox tonda d. 19,5 cm	166	50CA583826	cassa universale c/ coperchio 58x38 h26 40 litri col. trasparente	352
40-W088	forma inox tonda d. 29,5 cm	166	50CA583826B	cassa universale c/ coperchio 58x38 h26 40 litri col. bianco	352
40-W089	forma inox tonda d. 39,5 cm	166	50CA583838	cassa universale c/ coperchio 58x38 h38 60 litri col. trasparente	352
40-W090	forma inox tonda d. 49,5 cm	166	50CA583838B	cassa universale c/ coperchio 58x38 h38 60 litri col. bianco	352
40-W101	colonnine arancio d. 6 mm	417	50CA604007C	cassa in pe 60x40 h 7 cm 12 litri	353
40-W106	struttura tonda porta torta	416	50CA604007F	cassa forata in pe 60x40 h 7 cm 12 litri	353
40-W109	manuale "Sweet Airbrush"	312	50CA604010C	cassa in pe 60x40 h 10 cm 18 litri	353
40-W110	tamburo tondo d. 20 cm	417	50CA604013C	cassa in pe 60x40 h 13 cm 24 litri	353
40-W111	tamburo tondo d. 30 cm	417	50CA604018F	cassa forata in pe 60x40 h 10 cm 18 litri	353
40-W112	tamburo tondo d. 40 cm	417	50CA604024F	cassa forata in pe 60x40 h 13 cm 24 litri	353
40-W113	tamburo tondo d. 50 cm	417	50CA6040COP	coperchio per cassa 60x40 cm	353
40-W124	piatto in plastica d.58 cm c/anello	417	50CA6344C	cassa milleusi 63x44 h34 65 litri	353
40-W125	giratorcia inclinabile	256	50CA6344F	cassa forata 63x44 h34 65 litri	353
40-W154	mattarello diam. 45 l. 350 mm	270	50CA65COP	coperchio per cassa da 65 litri	353
40-W208	disco sottotorta d. 34 cm	417	50CA7247C	cassa milleusi 72x47 h36 90 litri	353
40-W209	dischi sottotorta d. 36 cm	417	50CA90COP	coperchio per cassa milleusi 90 litri	353
40-W210	dischi sottotorta d. 38 cm	417	50CF03PP	caraffa pp graduata 2 litri bianca	238
40-WC015	polvere pearl bronzo 5 gr af	296	50CF04PP	caraffa pp graduata 3 litri bianca	238
40-WC017	polvere pearl oro lustre 5 gr af	296	50CF05PP	caraffa pp graduata 5 litri bianca	238
40-WC020	polvere pearl rame 5 gr af	296	50CI086040	contenitore isotermico 60x40	351
40-WC119	polvere pearl argento chiaro 5 gr af	296	50CI126040	contenitore isotermico 60x40	351
40-WC300	polvere lacca bianca 5 gr af	297	50CI166040	contenitore isotermico gastronorm	350
40-WC302	polvere lacca blu 5 gr af	297	50CI216040	contenitore isotermico 60x40	351
40-WC304	polvere lacca gialla 5 gr af	297			

50CI276040	contenitore isothermico 60x40	351	53TAF60804	teglia piana alluminio forato 15/10 60x80 4 bordi	233
50CI280GN	contenitore isothermico gastronorm	350	53TL60402	teglia lamiera alluminata sp. 0,8 60x40 h2 cm 2 bordi	233
50CI316040	contenitore isothermico 60x40	351	53TL60404	teglia lamiera alluminata sp. 0,8 60x40 h2 cm 4 bordi	233
50CI5050BC	base e coperchio 50x50 ideal for cake	347	53TL60802	teglia lamiera alluminata sp. 0,8 60x80 h2 cm 2 bordi	233
50CI5050ES	estensore 50x50 ideal for cake	347	53TL60804	teglia lamiera alluminata sp. 0,8 60x80 h2 cm 4 bordi	233
50CI540GN	contenitore isothermico gastronorm caricamento frontale	348	54CF04PP	caraffa pp graduata 3 litro bianca	238
50CI6040	contenitore isothermico 60x40 caricamento frontale	349	54SE19PP	sessola in pp tonda 19 cm	239
50CIA001	supporto salva guida contenitore gastronorm kit 12 pcs.	348	54SE24PP	sessola in pp tonda 24 cm	239
50CIA002	supporto salva guida contenitore 60x40 kit 9 pcs.	349	54SE29PP	sessola in pp tonda 29 cm	239
50CIA003	carrello plastica 610x410 mm	350	54SE34PP	sessola in pp tonda 34 cm	239
50CIA004	inserto hot & cold system - gn 1/1	350	54SE38PP	sessola in pp tonda 38 cm	239
50CIA005	piastra eutettica 0 / -21 °c gn	350	54SE42PP	sessola in pp tonda 42 cm	239
50CIA006	inserto hot&cold system per contenitori 60x40 cm	351	55CF05PP	caraffa pp graduata 5 litro bianca	238
50CIA007	piastra eutettica 60x40cm -21 °c	351	5H4X10	quadrato lato 10 cm h 4 cm	167
50CIA008	piastra eutettica 0 / -6 °c universal	350	5H4X12	quadrato lato 12 cm h 4 cm	167
50CO001	colino professionale completo	262	5H4X14	quadrato lato 14 cm h 4 cm	167
50CORICO	ricambio bocchetta d.5	262	5H4X16	quadrato lato 16 cm h 4 cm	167
50CORIC1	ricambio bocchetta d.4	262	5H4X18	quadrato lato 18 cm h 4 cm	167
50CORIC2	ricambio bocchetta d.2	262	5H4X20	quadrato lato 20 cm h 4 cm	167
50CORIC3	ricambio manico	262	5H4X22	quadrato lato 22 cm h 4 cm	167
50CORIC4	ricambio asta	262	5H4X24	quadrato lato 24 cm h 4 cm	167
50CORIC5	ricambio imbuto	262	5H4X26	quadrato lato 26 cm h 4 cm	167
50CORIC6	ricambio supporto	262	5H4X28	quadrato lato 28 cm h 4 cm	167
50CORIC7	ricambio mandrino	262	5H4X30	quadrato lato 30 cm h 4 cm	167
50FLOOC	flacone graduato rettangolare con copri tappo	236	5H5X10	quadrato lato 10 cm h 5 cm	167
50GIRA01	ghiera girapanettoni in acciaio inox 200x40	179	5H5X12	quadrato lato 12 cm h 5 cm	167
50GO300	spatola in gomma con manico in polip. 30 cm	265	5H5X14	quadrato lato 14 cm h 5 cm	167
50GO350	spatola in gomma con manico in polip. 35 cm	265	5H5X16	quadrato lato 16 cm h 5 cm	167
50GO400	spatola in gomma con manico in polip. 40 cm	265	5H5X18	quadrato lato 18 cm h 5 cm	167
50PF00	portafacone 4 sedi in plexiglass	236	5H5X20	quadrato lato 20 cm h 5 cm	167
50SA150B	spatola angolare 150 mm	264	5H5X22	quadrato lato 22 cm h 5 cm	167
50SA250B	spatola angolare 250 mm	264	5H5X24	quadrato lato 24 cm h 5 cm	167
50SE09PEB	secchio in pe con becco 9 litri	238	5H5X26	quadrato lato 26 cm h 5 cm	167
50SE12PEB	secchio in pe con becco 12 litri	238	5H5X28	quadrato lato 28 cm h 5 cm	167
50SE15PEB	secchio in pe con becco 15 litri	238	5H5X30	quadrato lato 30 cm h 5 cm	167
50SG250B	spatola in gomma 25 cm color bianco con anima in polic	264	60P00100	pirottino trasparente 70 gr.	331
50SG300B	spatola in gomma 30 cm color bianco con anima in polic	264	60P00100/12	pirottino trasparente 70 gr.	331
50SG350B	spatola in gomma 35 cm color bianco con anima in polic	264	60P00102	pirottino celeste 70 gr.	331
50SL300B	spatola liscia 30 cm color bianco	264	60P00102/12	pirottino celeste 70 gr.	331
50SL370B	spatola liscia 37 cm color bianco	264	60P00107	pirottino rosa 70 gr.	331
50SP300B	spatola in plastica 30 cm color bianco	265	60P00107/12	pirottino rosa 70 gr.	331
50SP350B	spatola in plastica 35 cm color bianco	265	60P00108	pirottino rosso 70 gr.	331
50SP400B	spatola in plastica 40 cm color bianco	265	60P00108/12	pirottino rosso 70 gr.	331
50T001	termometro digitale multi funzione	134	60P00109	pirottino verde 70 gr.	331
50VA001A	vaso porta sac a poche in plastica arancio	225	60P00109/12	pirottino verde 70 gr.	331
50VP00402	vassoio in plex con bordi 140x400 mm (per eclair)	182	60P00111	pirottino giallo 70 gr.	331
50VP0100	145 x 400 mm h. 20 mm vassoio bianco	243	60P00111/12	pirottino giallo 70 gr.	331
50VP0103	145 x 400 mm h. 20 mm vassoio arancio	243	60P00121	pirottino fucsia 70 gr.	331
50VP0108	145 x 400 mm h. 20 mm vassoio nero	243	60P00121/12	pirottino fucsia 70 gr.	331
50VP0111	145 x 400 mm h. 20 mm vassoio verde	243	60P00200	pirottino trasparente 120 gr.	331
50VP0112	145 x 400 mm h. 20 mm vassoio giallo	243	60P00200/12	pirottino trasparente 120 gr.	331
50VP0117	145 x 400 mm h. 20 mm vassoio lilla	243	60P00202	pirottino celeste 120 gr.	331
50VP0200	145 x 289 mm h. 20 mm vassoio bianco	243	60P00202/12	pirottino celeste 120 gr.	331
50VP0203	145 x 289 mm h. 20 mm vassoio arancio	243	60P00207	pirottino rosa 120 gr.	331
50VP0208	145 x 289 mm h. 20 mm vassoio nero	243	60P00207/12	pirottino rosa 120 gr.	331
50VP0211	145 x 289 mm h. 20 mm vassoio verde	243	60P00208	pirottino rosso 120 gr.	331
50VP0212	145 x 289 mm h. 20 mm vassoio giallo	243	60P00208/12	pirottino rosso 120 gr.	331
50VP0217	145 x 289 mm h. 20 mm vassoio lilla	243	60P00209	pirottino verde 120 gr.	331
50VP0300	204 x 258 mm h 20 mm vassoio bianco	243	60P00209/12	pirottino verde 120 gr.	331
50VP0303	204 x 258 mm h 20 mm vassoio arancio	243	60P00211	pirottino giallo 120 gr.	331
50VP0308	204 x 258 mm h 20 mm vassoio nero	243	60P00211/12	pirottino giallo 120 gr.	331
50VP0311	204 x 258 mm h 20 mm vassoio verde	243	60P00221	pirottino fucsia 120 gr.	331
50VP0312	204 x 258 mm h 20 mm vassoio giallo	243	60P00221/12	pirottino fucsia 120 gr.	331
50VP0317	204 x 258 mm h 20 mm vassoio lilla	243	61-0003	cofanetto + vassoio 4 sedi grandi	336
50VP0400	294 x 394 mm h. 30 mm vassoio bianco	243	61-0004	cofanetto + vassoio 6 sedi grandi	336
50VP0403	294 x 394 mm h. 30 mm vassoio arancio	243	7H4X10	cuore d.10 cm h 4 cm	168
50VP0408	294 x 394 mm h. 30 mm vassoio nero	243	7H4X12	cuore d.12 cm h 4 cm	168
50VP0411	294 x 394 mm h. 30 mm vassoio verde	243	7H4X14	cuore d.14 cm h 4 cm	168
50VP0412	294 x 394 mm h. 30 mm vassoio giallo	243	7H4X16	cuore d.16 cm h 4 cm	168
50VP0417	294 x 394 mm h. 30 mm vassoio lilla	243	7H4X18	cuore d.18 cm h 4 cm	168
50WA004B	valigetta 12 attrezzi + raschietto + marcatore	314	7H4X20	cuore d.20 cm h 4 cm	168
50WA005B	valigetta 12 attrezzi + raschietto + marcatore	314	7H4X22	cuore d.22 cm h 4 cm	168
50WA006B	coltello colore bianco	314	7H4X24	cuore d.24 cm h 4 cm	168
51CF6040	carta da forno fogli 60x40 cm	232	7H4X26	cuore d.26 cm h 4 cm	168
51EC2512	dima per eclaire teglia 59x39	182	7H4X28	cuore d.28 cm h 4 cm	168
51EC6018	dima per eclaire teglia 59x39	182	7H5X10	cuore d.10 cm h 5 cm	168
51MA0032	dima per macarons teglia 59x39	181	7H5X12	cuore d.12 cm h 5 cm	168
51VA200	vassoio con bordo 200x150 h12	352	7H5X14	cuore d.14 cm h 5 cm	168
51VA280	vassoio con bordo 280x190 h12	352	7H5X16	cuore d.16 cm h 5 cm	168
51VA350	vassoio con bordo 350x240 h12	352	7H5X18	cuore d.18 cm h 5 cm	168
51VA420	vassoio con bordo 420x300 h12	352	7H5X20	cuore d.20 cm h 5 cm	168
51VA500	vassoio con bordo 500x360 h12	352	7H5X22	cuore d.22 cm h 5 cm	168
52BO13PC	bol in pc d. 13 0,4 litri	239	7H5X24	cuore d.24 cm h 5 cm	168
52BO13PP	bol in pp d.13 0,4 litri	239	7H5X26	cuore d.26 cm h 5 cm	168
52BO17PC	bol in pc d.17 1 litro	239	7H5X28	cuore d.28 cm h 5 cm	168
52BO17PP	bol in pp d.17 1 litro	239	80-2003	portatorta in plastica 3 piani	409
52BO23PC	bol in pc d.23 2,5 litri	239	80-2004	portatorta in plastica 4 piani	409
52BO23PP	bol in pp d.23 2,5 litri	239	80-2005	portatorta in plastica 5 piani	409
52BO28PC	bol in pc d.28 4 litri	239	80-2006	portatorta in plastica 6 piani	409
52BO28PP	bol in pp d.28 4 litri	239	80-2007	portatorta in plastica 7 piani	409
52BO32PC	bol in pc d.32 8 litri	239	80-2008	portatorta in plastica 8 piani	409
52BO32PP	bol in pp d.32 8 litri	239	80-2009	portatorta in plastica 9 piani	409
52BO38PC	bol in pc d.38 10 litri	239	8H4X10	goccia d.10 cm h 4 cm	168
52BO38PP	bol in pp d.38 10 litri	239	8H4X12	goccia d.12 cm h 4 cm	168
52CF01PP	caraffa pp graduata 0,5 litri bianca	238	8H4X14	goccia d.14 cm h 4 cm	168
52CF02PP	caraffa pp graduata 1 litro bianca	238	8H4X16	goccia d.16 cm h 4 cm	168
53CF03PP	caraffa pp graduata 2 litro bianca	238	8H4X18	goccia d.18 cm h 4 cm	168
53G060	aghi gira panettoni 60cm	179	8H4X20	goccia d.20 cm h 4 cm	168
53TA60402	teglia in alluminio sp 1,5 60x40 h 2 cm 2 bordi	233	8H4X22	goccia d.22 cm h 4 cm	168
53TA60404	teglia in alluminio sp 1,5 60x40 h2 cm 4 bordi	233	8H4X24	goccia d.24 cm h 4 cm	168
53TA60802	teglia in alluminio sp 1,5 60x80 h2 cm 2 bordi	233	8H4X26	goccia d.26 cm h 4 cm	168
53TA60804	teglia in alluminio sp 1,5 60x80 h2 cm 4 bordi	233	8H4X28	goccia d.28 cm h 4 cm	168
53TAF60404	teglia piana alluminio forato 15/10 60x40 4 bordi	233	8H4X30	goccia d.30 cm h 4 cm	168

8H5X10	goccia d.10 cm h 5 cm	168	BF 317	bocchette stella 16 punte d.15 mm	226
8H5X12	goccia d.12 cm h 5 cm	168	BF 318	bocchette stella 17 punte d.16 mm	226
8H5X14	goccia d.14 cm h 5 cm	168	BF 319	bocchette stella 18 punte d.18 mm	226
8H5X16	goccia d.16 cm h 5 cm	168	BFRU25	frusta acciaio inox 25 cm 8 fili	248
8H5X18	goccia d.18 cm h 5 cm	168	BFRU30	frusta acciaio inox 30 cm 8 fili	248
8H5X20	goccia d.20 cm h 5 cm	168	BFRU35	frusta acciaio inox 35 cm 8 fili	248
8H5X22	goccia d.22 cm h 5 cm	168	BFRU40	frusta acciaio inox 40 cm 8 fili	248
8H5X24	goccia d.24 cm h 5 cm	168	BFRU45	frusta acciaio inox 45 cm 8 fili	248
8H5X26	goccia d.26 cm h 5 cm	168	BFRU50	frusta acciaio inox 50 cm 8 fili	248
8H5X28	goccia d.28 cm h 5 cm	168	BIM 232	bocchetta imbutino conf. 5 pz	228
8H5X30	goccia d.30 cm h 5 cm	168	BIM 340	bocchette imbutino conf. 5 pz	228
90-1000/90-14241	stampi cioccolato polietilene	66-87	BO1000N	flacone graduato 1000 cc	237
9H4X10	virgola d.10 cm h 4 cm	168	BO100N	flaconcino graduato 100 cc	237
9H4X12	virgola d.12 cm h 4 cm	168	BO250N	flaconcino graduato 250 cc	237
9H4X14	virgola d.14 cm h 4 cm	168	BO500N	flaconcino graduato 500 cc	237
9H4X16	virgola d.16 cm h 4 cm	168	BOS 24	bocchette da decoro	230
9H4X18	virgola d.18 cm h 4 cm	168	BOS 26	bocchette piccole	229
9H4X20	virgola d.20 cm h 4 cm	168	BOS 36 BIG	bocchette grandi miste	229
9H4X22	virgola d.22 cm h 4 cm	168	BOS 52	bocchette piccole conf. 52 pz	229
9H4X24	virgola d.24 cm h 4 cm	168	BOS 60	conf. 60 pz bocchette da decoro	230
9H4X26	virgola d.26 cm h 4 cm	168	BOSPL 1	bocchette plastica h 5 cm	231
9H4X28	virgola d.28 cm h 4 cm	168	BOSPL 2	bocchette plastica h 5 cm	231
9H5X10	virgola d.10 cm h 5 cm	168	BOSPL 3	bocchette plastica h 3 cm	231
9H5X12	virgola d.12 cm h 5 cm	168	BOSPL 4	bocchette plastica h 3 cm	231
9H5X14	virgola d.14 cm h 5 cm	168	BPL 6	bocchette plastica miste 6 pz	231
9H5X16	virgola d.16 cm h 5 cm	168	BR 330	bocchette foro fiore d. 5 mm conf. 5 pz	226
9H5X18	virgola d.18 cm h 5 cm	168	BR 331	bocchette foro fiore d. 6 mm conf. 5 pz	226
9H5X20	virgola d.20 cm h 5 cm	168	BR 332	bocchette foro fiore d. 8 mm conf. 5 pz	226
9H5X22	virgola d.22 cm h 5 cm	168	BRU	bruschino per bocchette	231
9H5X24	virgola d.24 cm h 5 cm	168	BS 0195	bocchetta inox conf. 5 pz	228
9H5X26	virgola d.26 cm h 5 cm	168	BS 0195K	bocchetta inox conf. 5 pz	228
9H5X28	virgola d.28 cm h 5 cm	168	BS 0D6K	bocchetta inox conf. 5 pz	228
AG05600	porta macarons in plex 27x33 h14 bianco	244	BS 0F6K	bocchetta inox conf. 5 pz	228
AG05601	porta macarons in plex 27x33 h14 trasp.	244	BS 10 S	bocchette metallo foro stella miste 10pz	229
AG05700	porta macarons in plex 46x33 h14 bianco	244	BS 10 T	bocchette metallo foro tondo miste	229
AG05701	porta macarons in plex 46x33 h14 trasp.	244	BS 102	bocchette foro stella d. 2 mm conf. 5 pz	226
AG05800	porta macarons in plex 31x32 h6 bianco	244	BS 103	bocchette foro stella d. 3 mm conf. 5 pz	226
AG05801	porta macarons in plex 31x32 h6 trasp.	244	BS 104	bocchette foro stella d. 4 mm conf. 5 pz	226
AG07701	porta macarons alzata	245	BS 105	bocchette foro stella d. 5 mm conf. 5 pz	226
AG07701P	porta macarons alzata piccola	245	BS 106	bocchette foro stella d. 6 mm conf. 5 pz	226
AG07801	porta macarons triangolare	244	BS 107	bocchette foro stella d. 7 mm conf. 5 pz	226
AG078901	porta macarons piramide	244	BS 108	bocchette foro stella d. 8 mm conf. 5 pz	226
AG08001	porta macarons 7 sedi	245	BS 109	bocchette foro stella d. 9 mm conf. 5 pz	226
AG08101	porta macarons verticale	245	BS 110	bocchette foro stella d.10 mm conf. 5 pz	226
AG08201	porta macarons fiore	245	BS 111	bocchette foro stella d.11 mm conf. 5 pz	226
ANELLO	anello separatore basi	394	BS 112	bocchette foro stella d.12 mm conf. 5 pz	226
ARO001	parafiatto trasparente	242	BS 113	bocchette foro stella d.13 mm conf. 5 pz	226
ARO0011	parafiatto trasparente	242	BS 114	bocchette foro stella d.14 mm conf. 5 pz	226
ARO2801	vetrina parafiatto trasparente	242	BS 115	bocchette foro stella d.15 mm conf. 5 pz	226
ARTISTIK 2	il grande manuale dei pezzi da esposiz.	312	BS 116	bocchette foro stella d.16 mm conf. 5 pz	226
ARTISTIK3	il grande manuale delle torte artistik	312	BS 117	bocchette foro stella d.17 mm conf. 5 pz	226
BA 411	bocchette fiore aperto d. 11 mm	226	BS 118	bocchette foro stella d.18 mm conf. 5 pz	226
BA 413	bocchette fiore aperto d. 13 mm	226	BST100	kit bastoncini per gelato colori misti	188
BA 415	bocchette fiore aperto d. 15 mm	226	BT 202	bocchetta foro tondo d.2 mm conf. 5 pz	226
BASKET 102	cestino per l'impasto 29x18 cm	269	BT 203	bocchette foro tondo d.3 mm conf. 5 pz	226
BASKET 103	cestino per l'impasto 22x14 cm	269	BT 204	bocchette foro tondo d.4 mm conf. 5 pz	226
BASKET 105	cestino per l'impasto 40x14 cm	269	BT 205	bocchette foro tondo d.5 mm conf. 5 pz	226
BASKET 106	cestino per l'impasto 35x13 cm	269	BT 206	bocchette foro tondo d.6 mm conf. 5 pz	226
BASKET 107	cestino per l'impasto 27x12 cm	269	BT 207	bocchette foro tondo d.7 mm conf. 5 pz	226
BASKET 108	cestino per l'impasto 24x14 cm	269	BT 208	bocchette foro tondo d.8 mm conf. 5 pz	226
BASKET 205	cestino per l'impasto d. 25 cm	269	BT 209	bocchette foro tondo d.9 mm conf. 5 pz	226
BASKET 206	cestino per l'impasto d. 21.5 cm	269	BT 210	bocchette foro tondo d.10 mm conf. 5 pz	226
BASKET 207	cestino per l'impasto d. 18 cm	269	BT 211	bocchette foro tondo d.11 mm conf. 5 pz	226
BASKET 208	cestino per l'impasto d. 13 cm	269	BT 212	bocchette foro tondo d.12 mm conf. 5 pz	226
BBP1	scatola bocchette in plastica 12 pz	230	BT 213	bocchette foro tondo d.13 mm conf. 5 pz	226
BBP2	scatola bocchette in plastica 12 pz	230	BT 214	bocchette foro tondo d.14 mm conf. 5 pz	226
BBP3	scatola bocchette in plastica 24 pz.	230	BT 215	bocchette foro tondo d.15 mm conf. 5 pz	226
BC 0855	bocchetta inox conf. 5 pz	228	BT 216	bocchette foro tondo d.16 mm conf. 5 pz	226
BC 320	bocchette stella foro chiuso d. 2 mm	226	BT 217	bocchette foro tondo d.17 mm conf. 5 pz	226
BC 321	bocchette stella punta chiusa d. 3 mm	226	BT 218	bocchette foro tondo d.18 mm conf. 5 pz	226
BC 322	bocchette stella punta chiusa d. 4 mm	226	BT 220	bocchette foro tondo d.20 mm conf. 5 pz	226
BC 323	bocchette stella punta chiusa d. 5 mm	226	BT 222	bocchette foro tondo d.22 mm conf. 5 pz	226
BC 324	bocchette stella punta chiusa d. 6 mm	226	BT 224	bocchette foro tondo d.24 mm conf. 5 pz	226
BC 325	bocchette stella punta chiusa d. 7 mm	226	BX 0108	bocchetta inox conf. 5 pz	228
BC 326	bocchette stella punta chiusa d. 8 mm	226	BX 0116	bocchetta inox conf. 5 pz	228
BC 327	bocchette stella punta chiusa d. 9 mm	226	BX 0119	bocchetta inox conf. 5 pz	228
BC 328	bocchette stella punta chiusa d.10 mm	226	BX 0120	bocchetta inox conf. 5 pz	228
BC 329	bocchette stella punta chiusa d. 11 mm	226	BX 0123	bocchetta inox conf. 5 pz	228
BC 330	bocchette stella punta chiusa d. 12 mm	226	BX 0134	bocchetta inox conf. 5 pz	228
BCM002	imballo per bicchierini cap. 2 pz	334	BX 0158	bocchetta inox conf. 5 pz	228
BCM004	imballo per bicchierini cap. 4 pz	334	BX 0190	bocchetta inox conf. 5 pz	228
BCM006	imballo per bicchierini cap. 6 pz	334	BX 0250	bocchetta inox conf. 5 pz	228
BCM012	imballo per bicchierini cap. 12 pz	334	BX 0252	bocchetta inox conf. 5 pz	228
BCM100	bauletto c/vassoio 4 sedi conf. 25pz	335	BX 0510	bocchetta inox conf. 5 pz	228
BCM101	bauletto c/vassoio 6 sedi	335	BX 1013	bocchetta acciaio inox d. 13 mm h 43 mm	227
BCM102	bauletto c/vassoio 8 sedi	335	BX 1105	bocchetta acciaio inox d. 5 mm h 52 mm	226
BCM103	bauletto c/vassoio 12 sedi	335	BX 1115	bocchetta acciaio inox d. 5 mm h 42 mm	226
BD 300	bocchetta delizia 16x2 mm conf. 5 pz	226	BX 1123	bocchetta acciaio inox d. 3 mm h 42 mm	226
BD 301	bocchette delizia 20x3 mm conf. 5 pz	226	BX 1132	bocchetta acciaio inox d. 2 mm h 42 mm	226
BD 302	bocchette delizia 28x4 mm conf. 5 pz	226	BX 1217	bocchetta acciaio inox 3x17 mm h 40 mm	227
BDM01.01	bicchiere conico in plastica	380	BX 1303	bocchetta acciaio inox 3x17 mm h 43 mm	227
BDM01.02	bicchiere conico in plastica	380	BX 1405	bocchetta acciaio inox 5x20 mm h 43 mm	227
BDM02	bicchiere triangolare trasparente	383	BX 1510	bocchetta acciaio inox 10x22 mm h 52 mm	227
BF 0867	bocchetta inox conf. 5 pz	228	BX 1605	bocchetta acciaio inox 8x5 mm h 52 mm	227
BF 0869	bocchetta inox conf. 5 pz	228	BX 1713	bocchetta acciaio inox d. 13 mm h 40 mm	227
BF 310	bocchette stella 9 punte d. 4 mm	226	BX 1820	bocchetta acciaio inox d. 20 mm h 42 mm	227
BF 311	bocchette stella 9 punte d. 6 mm	226	BX 1906	bocchetta acciaio inox 17x6 mm h 47 mm	227
BF 312	bocchette stella 10 punte d. 7 mm	226	BX 2013	bocchetta acciaio inox d. 13 mm h 42 mm	227
BF 313	bocchetta stella 12 punte d.9 mm	226	BX 2117	bocchetta acciaio inox d. 17 mm h 45 mm	227
BF 314	bocchette stella 14 punte d.10 mm	226	BX 2219	bocchetta acciaio inox d. 19 mm h 52 mm	227
BF 314/11	bocchette stella 14 punte d.11	226	BX 2312	bocchetta acciaio inox d. 12 mm h 41 mm	226
BF 315	bocchette stella 15 punte d.12 mm	226	BX 2314	bocchetta acciaio inox d. 14 mm h 39 mm	226
BF 316	bocchette stella 15 punte d. 13 mm	226	BX 2315	bocchetta acciaio inox d. 15 mm h 46 mm	226

BX 3005	bocchetta acciaio inox d. 5 mm h 50 mm	227	COD. 117	portatorta mod. la culla	396
BX 4014	bocchetta acciaio inox d. 14 mm h 50 mm	227	COD. 118	base diametro 85 cm con piatti	395
BX 5017	bocchetta acciaio inox d. 17 mm h 47 mm	227	COD. 118/F	base 85 cm per fontana	395
BX 6018	bocchetta acciaio inox d. 18 mm h 48 mm	227	COD. 121	portatorta mod. ponte	397
BX 7020	bocchetta acciaio inox d. 20 mm h 52 mm	227	COD. 122	portatorta mod. la conchiglia	397
BX 8019	bocchetta acciaio inox d. 19 mm h 52 mm	227	COD. 123	portatorta mod. margherita piccola	408
BX 9017	bocchetta acciaio inox 3x17 mm h 52 mm	226	COD. 124	portatorta mod. margherita grande	408
BX 9022	bocchetta acciaio inox 3x22 mm h 53 mm	226	COD. 126/A	portatorta mod. due cuori grandi	408
CANNELLO PRO	cannello professionale multiuso	247	COD. 126/B	portatorta mod. due cuori piccoli	408
CANNELLOBIG	cannello professionale multiuso	247	COD. 127	portatorta mod. torre eiffel	400
CANNELLOBL	cannello a gas	247	COD. 129	portatorta mod. cicogna	401
CANNOLO	cannoli 30x120 mm conf. 10 pz	234	COD. 130	portatorta mod. colonna quadrata	401
CAP 1	cappelli mod. economico h 21 cm cf.10 pz	249	COD. 131	portatorta mod. colonna rotonda	401
CAP 1B	cappelli mod. excellent h 21 cm cf.10 pz	249	COD. 132	portatorta mod. colonna cuore	401
CAP 2	cappelli non woven mod. le chef h 25 cm	249	COD. 135	portatorta mod. cigno piccolo	399
CAP 2B	cappelli mod. economico le chef h 25 cm	249	COD. 136	portatorta mod. cigno medio	399
CAP 3	cappello in carta mod. europa h 20 cm	249	COD. 137	portatorta mod. cigno grande	399
CAP 4	bustina neutra regolabile	249	COD. 138	portatorta mod. cigno completo	399
CAP 5	bustina colorata regolabile	249	COD. 150	portatorta mod. la scala	403
CAR 2	carrello plastica porta ceste 45x60 cm	352	COD. 152	portatorta mod. romantica	402
CARNEVAL 1	set 3 pz maschere grandi	62	COD. 153	portatorta mod. semiramide	402
CARNEVAL 2	set 4 pz maschere piccole	62	COD. 155	portatorta mod. inglese	405
CF 1	caraffa graduata 1 lt	238	COD. 156	portatorta mod. inglese a	405
CF 2	caraffa graduata 2 lt	238	COD. 157	portatorta mod. inglese b	405
CF 3	caraffa graduata 3 lt	238	COD. 158	portatorta mod. inglese c	405
CF 5	caraffa graduata 5 lt	238	COD. 159	portatorta mod. manhattan	402
CFTRA 1	caraffa graduata trasparente 0,5 lt	238	COD. 160	portatorta mod. flora	404
CFTRA 2	caraffa graduata trasparente 1 lt	238	COD. 161	portatorta mod. flora grande	404
CFTRA 3	caraffa graduata trasparente 2 lt	238	COD. 162	portatorta mod. flora media	404
CFTRA 4	caraffa graduata trasparente 3 lt	238	COD. 163	portatorta mod. flora piccola	404
CHASIL 1 - 18	tappettino per decorazioni di cioccolato	135	COD. 170	portatorta gazebo su base rotonda	398
CHIT15	telaio frontale per chitarra mini da 15 cm	216	COD. 180	portatorta mod. daisy	403
CHIT22	telaio per chitarra mini da 22,5 cm	216	COD. 183	portatorta mod. memphis	406
CHIT30	telaio per chitarra mini da 30 cm	216	COD. 184	portatorta mod. bignolata piccola	407
CHITBA24	base per chitmini completa di accessori	216	COD. 185	portatorta mod. bignolata grande	407
CHITBAD24	base in pst 240x240 mm per chitarra mini doppia	217	COD. 186	portatorta mod. velocipede	398
CHITCOMP	chitarra semplice completa di 3 telai	212	COD. 187	portatorta mod. carrozzina	396
CHITDOUBLE	chitarra doppia completa di 4 telai	213	COD. 188	portatorta mod. trifoglio	403
CHITMINI	mini chitarra per ganaches	216	COD. 189	portatorta mod. rio	406
CHITMINI15	mini chitarra per ganaches	216	COD. 190	portatorta mod. gradus	403
CHITMINI30	mini chitarra per ganaches	216	COD. 192	portatorta mod. milano	402
CHITMINID22	chitarra mini doppia con due telai da 22,5 cm	217	COD. 196	portatorta mod. fiore di loto	406
CHITMINID30	chitarra mini doppia con due telai da 30 cm	217	COD. 196/B	portatorta mod. fiore di loto grande	407
CHITP	piatto inox per chitarra mini	216	COD. 201	portatorta mod. inglese tondo	414
CHITRIC 1	telaio chitarra semplice 15 mm	212	COD. 202	portatorta mod. inglese ovale	414
CHITRIC 1/D	telaio per chitarra doppia 15 mm	213	COD. 203	portatorta mod. inglese rettangolare	414
CHITRIC 1/LD	telaio laterale per chitarra doppia 30mm	213	COD. 204	portatorta mod. inglese quadrata	414
CHITRIC 10	coppia tiranti corde chitarra con dadi	216	COD. 300	mod. light alzata col. arancio e bianco	362
CHITRIC 2	telaio chitarra semplice 22,5 mm	212	COD. 301	mod. light alzata col. giallo e bianco	362
CHITRIC 2/D	telaio chitarra doppia 22,5 mm	213	COD. 302	mod. light alzata col. arancio e bianco	362
CHITRIC 2/LD	telaio laterale chitarra doppia 20 mm	213	COD. 303	mod. light alzata col. rosso e bianco	363
CHITRIC 2/T	telaio per chitarra per tronchi 22,5 mm	219	COD. 304	mod. light alzata col. verde e bianco	363
CHITRIC 3	telaio chitarra semplice 30 mm	212	COD. 305	mod. light alzata col. satinato metallo	368
CHITRIC 3/D	telaio chitarra doppia 30 mm	213	COD. 307	mod. light alzata col. satinato metallo	368
CHITRIC 4	telaio chitarra semplice 45 mm	212	COD. 308	mod. light alzata col. arancio e bianco	363
CHITRIC 4/D	telaio chitarra doppia 45 mm	213	COD. 309	alzatina light 4 cubi	365
CHITRIC 4/T	telaio per chitarra per tronchi 45 mm	219	COD. 310	alzatina light 3 ripiani	368
CHITRIC 5	base plastica chitarra semplice 39x45 cm	212	COD. 311	alzatina light cuore rosso	391
CHITRIC 5/D	base plastica chitarra doppia	213	COD. 312	alzatina light 4 ripiani triangolari	370
CHITRIC 6/D	piatto inox cm 42,5x42,5	212	COD. 313	alzatina light 3 ripiani triangolari	369
CHITRIC 8	kit 2 chiavi fissaggio chitarra	210	COD. 314	alzatina light 4 ripiani bi-color	369
CHITRIC 9	filo inox armonico x chitarra 0,7 mm.	210	COD. 315	alzata 4 ripiani plexiglass trasp.	369
CHITRIC10	2 dadi + 2 viti	212	COD. 316	display catering plexiglass nero e satinato	362
CHITRONK	chitarra semplice per tronchi	219	COD. 317	display catering plexiglass fiore rosso	366
CHOCO101	forchetta cioccolato a 2 rebbi	136	COD. 318	display catering plexiglass nero e satinato	366
CHOCO102	forchetta cioccolato 3 rebbi	136	COD. 319	display catering plexiglass fiore aranci	366
CHOCO103	forchetta cioccolato 4 rebbi	136	COD. 320	display catering plexiglass trasparente	361
CHOCO104	forchetta cioccolato spirale	136	COD. 321	display catering plexiglass rosso	360
CHOCO105	forchetta cioccolato tondo mm 16	136	COD. 322	display catering plexiglass arancione	360
CHOCO106	forchetta cioccolato tondo 20 mm	136	COD. 323	display catering plexiglass margherita	366
CHOCO107	forchetta cioccolato tondo 18 mm	136	COD. 32416	alzata catering albero col. marrone	365
CHOCO108	forchetta cioccolato tondo 14 mm	136	COD. 32418	alzata catering albero col. rosa	365
CHOCO109	forchetta cioccolato triangolo	136	COD. 32508	alzata catering 4 ripiani col. nero	367
CHOCO110	forchetta cioccolato goccia	136	COD. 32518	alzata catering 4 ripiani col. rosa	367
CHOCOBIG	fontana per cioccolato grande	15	COD. 32602	alzata catering tonda 3 ripiani col. verde	364
CHOCOBIGRING	anello per fontana chocobig	15	COD. 32617	alzata catering tonda 3 ripiani col. lilla	364
CHOCOBIGRING06	anello per fontana chocobig satinato	15	COD. 32715	alzata catering scala col. blu	364
CHOCOFONT	fontanina per cioccolato	15	COD. 32717	alzata catering scala col. lilla	364
CHOCOFORK	set 10 pz forchette per cioccolato	136	COD. 32816	alzata catering 4 piatti col. marrone	363
CHOCORING	anello per fontanina chocofont	15	COD. 32901	alzata catering 3 scalini col. trasp/satinato	360
CHOCORING06	anello per fontanina chocofont satinato	15	COD. 33001	alzata catering cubi decorati col. trasp.	367
CI12X200	stampo cannolo cilind. 12x200 mm 6 pz	234	COD. 33101	alzata catering 4 piatti quadrati col. trasp.	365
CI16X200	stampo cannolo cilind. 16x200 mm 6 pz	234	COD. 33118	alzata catering 4 piatti quadrati col. rosa	365
CI22X140	stampo cannolo cilind. 22x140 mm 6 pz	234	COD. 400.01	mod. iron c/tre ciotole da incastro	374
CIOK 1	grignottina 60x40 cm h 5 cm	259	COD. 400.02	mod. iron c/tre ciotole da incastro	374
CLP01	stampo gelato ice tube	189	COD. 401.01	mod. iron c/tre piatti triangolari	374
CLPESPO15	espositore ice tube satinato 15 pz	189	COD. 401.02	mod. iron c/tre piatti triangolari	374
CLPESPO21	espositore ice tube satinato 21 pz	189	COD. 402.01	mod. iron c/tre piatti lisci bianchi	374
CLPESPOB	espositore ice tube bianco 28 pz	189	COD. 403.01	mod. iron c/tre ciotole bianche	372
CLPESPOBTRA	espositore trasparente 25 pz	189	COD. 403.02	mod. iron c/tre ciotole nere	372
CO30X120	stampo per cannolo conico 30x120 mm 6 pz	234	COD. 404.01	mod. iron c/quattro ciotole barchetta	372
CO35X140	stampo per cannolo conico 35x140 mm 6 pz	234	COD. 404.02	mod. iron c/quattro ciotole barchetta	372
CO40X160	stampo per cannolo conico 40x160 mm 6 pz	234	COD. 405.01	mod. iron c/due ciotole barchetta	372
COATING	staccante alimentare 400 ml	299	COD. 405.02	mod. iron c/due ciotole barchetta	372
COD. 101	portatorta mod. classica quadrata	394	COD. 406.01	mod. iron h. 7cm c/piatto triangolare	373
COD. 102	portatorta mod. classica quadrata	394	COD. 406.02	mod. iron h. 7cm c/piatto triangolare	373
COD. 103	portatorta mod. classica rotonda	394	COD. 407.01	mod. iron h. 14cm c/piatto triangolare	373
COD. 104	portatorta mod. classica rotonda	394	COD. 407.02	mod. iron h. 14cm c/piatto triangolare	373
COD. 111	portatorta mod. fontana	395	COD. 408.01	mod. iron h. 18cm c/piatto triangolare	373
COD. 112	portatorta mod. americana	395	COD. 408.02	mod. iron h. 18cm c/piatto triangolare	373
COD. 113/A	portatorta mod. chiocciola	400	COD. 410	alzatina iron 3 ripiani tondi	370
COD. 113/B	portatorta mod. piramide	400	COD. 411	alzatina iron 3 ripiani ovali	370
COD. 116	portatorta mod. il veliero	398	COD. 412	alzatina iron 3 ripiani rettangolari	370

COD. 500	alzatina romantic 3 ripiani quadrati	371	CUT4L7	kit 7 pz. tagliapasta liscio triangolo	278
COD. 501	alzatina romantic 3 ripiani tondi	371	CUT50LM1	tagliapasta farfalla c/manico	276
COD. 502	alzatina romantic 3 ripiani ovali	371	CUT50LM2	kit 2 pz. tagliapasta farfalla c/manico	277
COD. 503	alzatina romantic 3 ripiani rettangolari	371	CUT5L7	kit 7 pz. tagliapasta liscio quadrato	278
COD. 504	alzatina romantic 5 ripiani tondi	390	CUT60LM1	tagliapasta orsetto c/manico	276
COD. 507	alzatina romantic 2 ripiani tondi	393	CUT60LM2	kit 2 pz. tagliapasta orsetto c/manico	277
COD. 508	alzatina romantic 2 ripiani tondi	393	CUT6L7	kit 7 pz. tagliapasta liscio rombo	278
COD. 509	alzatina romantic 3 ripiani tondi	393	CUT70LM1	tagliapasta bunny c/manico	276
COD. 510	alzata wedding cake farfalle	391	CUT70LM2	kit 2 pz. tagliapasta bunny c/manico	277
COD. 511	alzata wedding cake decoro fantasia	391	CUT7F9	tagliapasta cuore festonato	281
COD. 603	display in plexiglass trasp. 5 piani	369	CUT7L12	tagliapasta cuore liscio	281
COD. 604	chocolates mini display	29	CUT7L7	kit 7 pz. tagliapasta liscio cuore	281
COD33201	display ricci con 3 piani tondi	355	CUT7L9	tagliapasta cuore liscio conf. 9 pz	281
COD33301	display ali con 4 piani tondi	355	CUT80LM3	kit 3 pz. tagliapasta mela c/manico	277
COD33401	display cerchi con 3 piani tondi	356	CUT8L7	kit 7 pz. tagliapasta liscio goccia	278
COD33501	display stone bianchi e trasparenti 6 piani	357	CUT9L7	kit 7 pz. tagliapasta liscio virgola	278
COD33608	alzatina spicchi con 3 piatti neri + base	355	CUTTER 1	coltellino per pane in plastica fisso	274
COD33701	alzatina tre gradini semicerchio trasparente	358	CUTTER 10	coltellino lama inox ondulata 8 cm	274
COD33806	display cigno 6 ripiani con led color trasparente	354	CUTTER 11 SET	set 2 coltellini doppia lama ondulati	274
COD33906	alzatina tre gradini rettangolari satinata	358	CUTTER 12	coltellino doppia lama ondulata	274
COD34001	alzata tre gradini ondulati trasparente	358	CUTTER 13	cutter baguette con manico plastica 2 pz	274
COD35101	alzata cascata tre livelli trasparente	357	CUTTER 14	cutter pane in plastica con copri	274
COD60501	display buffet 4 piatti quadrati	356	CUTTER 15	coltellino per pane in plastica	274
COLONNA	colonna per cod. 111 mod. fontana	394	CUTTER 4	coltellino plastica lama girevole	274
COLONNINA	colonna distanziatrice per alzata	394	CUTTER 5	coltellino plastica lama dritta	274
CON 1 / 19	mascherina coniglio	302	CUTTER 5/A	coltellino plastica lama dritta	274
CONDISPENSER	dispenser con 4 vaschette da 2 lt	237	CUTTER 50	tagliapasta per art. sf014	177
CORT4	kit decorazione corteccia l.80 cm h 4	169	CUTTER 6	coltellino lama inox l. 5 cm	274
CORT5	kit decorazione corteccia l.80 cm h 5 cm	169	CUTTER 7	coltellino lama inox liscia l. 9 cm	274
COVER 3	coperchio plastica trasparente	263	CUTTER 8	coltellino lama inox ondulata 9 cm	274
COVER 4	coperchio in plastica trasparente	263	CUTTER 80	tagliapasta per art. sf047	177
COVER 8	coperchio plastica trasparente 59x39 h8	263	CUTTER 9	coltellino lama inox liscia 7 cm	274
COVER3H4	coperchio in plastica trasp. H 4 cm	263	DECO 2	facile manuale intaglio frutta e verdura	312
CREAM 1	cornice speciale cm 60x40 h 5 cm	257	DECO 24W	valigetta professionale per l'intaglio	312
CRWESPOWMONOUSO	growner per espositore monouso catering	289	DECO10T	trousse profess. per realizzare piccole	312
CS3	lira per pan di Spagna 3 lame	260	DECOAIR 2	penna aerografa doppia azione	290
CSM040	chitarra taglio spinta 40x40 cm	211	DECOAIR 3	penna aerografa doppia azione	290
CSM04001	telaio chitarra 10 mm	211	DECOAIR 4	penna aerografa foro 0.2 mm	290
CSM04002	telaio chitarra 15 mm	211	DECOAIR 5	penna doppia azione c/bicchierini grandi	290
CSM04003	telaio chitarra 20 mm	211	DECOAIR 6	penna per chablonatura doppia azione	290
CSM04004	telaio chitarra 25 mm	211	DECOCP01	cake paint set penna, compressore	291
CSM04005	telaio chitarra 30 mm	211	DECOF01	filtro per penna aerografa	291
CSM04006	telaio chitarra 35 mm	211	DECOH01	supporto per penna aerografa 4 sedi	291
CSM04007	telaio chitarra 40 mm	211	DECOMP 7	compressore col. arancio 4 atmosfere	291
CSM04008	telaio chitarra 50 mm	211	DECOMP 8	compressore "semiprofessionale" 2,5 bar	291
CSM04009	telaio chitarra 60 mm	211	DECOR 30	stampo decora crostate d. 30 cm	254
CSM0402	piatto inox per chitarra a spinta 40cm	211	DECOV01	vaschetta per pulizia aerografo	291
CSM060	chitarra taglio a spinta 60x60 cm	210	DISCO20	disco sottotorta d. 20 cm	260
CSM06001	telaio chitarra 10 mm	210	DISCO22	disco sottotorta d. 22 cm	260
CSM06002	telaio chitarra 15 mm	210	DISCO24	disco sottotorta d. 24 cm	260
CSM06003	telaio chitarra 20 mm	210	DISCO26	disco sottotorta d. 26 cm	260
CSM06004	telaio chitarra 25 mm	210	DISCO28	disco sottotorta d. 28 cm	260
CSM06005	telaio chitarra 30 mm	210	DISCO30	disco sottotorta d. 30 cm	260
CSM06006	telaio chitarra 35 mm	210	DISCO32	disco sottotorta d. 32 cm	260
CSM06007	telaio chitarra 40 mm	210	DISCO34	disco sottotorta d. 34 cm	260
CSM06008	telaio chitarra 50 mm	210	DISTRIBUTORE	distributore sacchetti mod.	225
CSM06009	telaio chitarra 60 mm	210	DRIP	sgocciolatore inox per silicoflex	177
CSM0602	piatto inox per chitarra a spinta 60cm	210	ED 1 / 9	estrattore mignon vari modelli	163
CSMSPB40	spatola in plastica per chitarra a spinta	211	EEX 0001 / 1	estrattore teglia extra	164
CSMSPB60	spatola in plastica per chitarra a spinta	210	EL101	espositore orizzont. lollypop da vetrina	37
CUT10L9	tagliapasta stella liscio conf. 9 pz	278	EL201	espositore orizzontale trasp. per lollypop	37
CUT12L7	kit 7 pz. tagliap. liscio fiore 6 petali	278	EL203	espositore verticale arancione lollypop	37
CUT12LM1	tagliapasta fiore 6 petali c/manico	276	EL209	espositore verticale fucsia lollypop	37
CUT14L7	kit 7 pz. tagliap. liscio fiore 3 petali	278	EL309	espositore orizzontale fucsia lollypop	37
CUT15L7	kit 7 pz. tagliapasta liscio luna	279	EM 01 / 15	estrattore monopuso catering	159-161
CUT15LM1	tagliapasta luna c/manico	276	EO3	tris estrattori ottag. per teglia torta	165
CUT16L7	kit 7 pz. tagliapasta liscio pentagono	279	ER3	tris estrattori tondi per teglia torta	165
CUT17L7	kit 7 pz. tagliapasta liscio tulipano	279	ESPICE	espositore trasp. baby ice per vetrine	188
CUT17LM2	kit 2 pz. tagliapasta tulipano c/manico	277	ESPICE14	espositore satinato baby ice per vetrine	188
CUT18L7	kit 7 pz. tagliapasta liscio uovo	279	ESPICE21	espositore satinato baby ice per vetrine	188
CUT19L7	kit 7 pz. tagliapasta liscio cuore	279	ESPO	espositore per bocchette nr 24 ganci	131
CUT19LM3	kit 3 pz. tagliapasta cuore c/manico	277	ESPO B	portasacchetti e attrezzi in plastica	131
CUT1F12	box tagliapasta festonati inox 12 pz	281	ESPO ST	portasacchetti e attrezzi in acciaio	131
CUT1F9	tagliapasta rotondo festonato 9 pz	281	ESPO20GU001	espositore in plex per conetti	23
CUT1FM12	tagliapasta rotondo festonato d. 12 cm	276	ESPOSITORE	espositore martellato bianco	288
CUT1FM14	tagliapasta rotondo festonato d.14 cm	276	ESPOWG70GP	espositore in legno per green poche	222
CUT1L12	tagliapasta tondi lisci	280	ESPOWMONOUSO	espositore per monouso catering	289
CUT1L16	tagliapasta tondi lisci	280	ET001	espositore tavolette cioccolato	128
CUT1L7	kit 7 pz. tagliapasta liscio tondo	280	ET003	espositore tavolette cioccolato	128
CUT1L9	tagliapasta rotondo liscio conf. 9 pz	280	ET004	espositore tavolette cioccolato	129
CUT1LM12	tagliapasta rotondo liscio d.12 cm	276	ET004B	espositore tavolette cioccolato	128
CUT1LM14	tagliapasta rotondo liscio d.14 cm	276	ET006	espositore tavolette cioccolato	128
CUT20L7	kit 7 pz. tagliap. liscio fiore 8 petali	279	EUROCHOCK	raffreddante spray uso alimentare 400 ml	299
CUT21L7	kit 7 pz. tagliapasta liscio foglia	279	EXTRA A / C	teglie extra mod. tondo	164
CUT22L7	kit 7 pz. tagliapasta liscio rettangolo	279	FLACONE	flacone annaffiatore per bagne 1 lt	236
CUT23L7	kit 7 pz. tagliap. liscio 5 petali	279	FLAN1	flacone rotondo per bagne 1 lt	237
CUT23LM1	tagliapasta fiore 5 petali c/manico	276	FLEX 025 CM	sacchetto mod. flex 25 cm	221
CUT24L7	kit 7 pz. tagliapasta liscio cuore	279	FLEX 028 CM	sacchetto mod. flex 28 cm	221
CUT25L7	kit 7 pz. tagliapasta liscio cuore	279	FLEX 034 CM	sacchetto mod. flex 34 cm	221
CUT26L7	kit 7 pz. tagliapasta liscio cuore	279	FLEX 040 CM	sacchetto mod. flex 40 cm	221
CUT27L7	kit 7 pz. tagliapasta liscio cuore	280	FLEX 046 CM	sacchetto mod. flex 46 cm	221
CUT27LM1	tagliapasta cuore c/manico	276	FLEX 050 CM	sacchetto mod. flex 50 cm	221
CUT27LM3	kit 3 pz. tagliapasta cuore c/manico	277	FLEX 055 CM	sacchetto mod. flex 55 cm	221
CUT28L7	kit 7 pz. tagliapasta liscio barchetta	280	FLEX 060 CM	sacchetto mod. flex 60 cm	221
CUT29L7	kit 7 pz. tagliapasta liscio bocca	280	FLEX 065 CM	sacchetto mod. flex 65 cm	221
CUT2F12	tagliapasta inox ovale festonato	281	FLEX 070 CM	sacchetto mod. flex 70 cm	221
CUT2F9	tagliapasta ovale festonato conf. 9 pz	281	FLOWER 1	chiodi per fiori d. 20 mm - 24pz	231
CUT2L12	tagliapasta inox ovale liscio	280	FLOWER 3	chiodi per fiori d. 35 mm - 24pz	231
CUT2L7	kit 7 pz. tagliapasta liscio ovale	280	FLOWER 4	chiodi per fiori d. 33 mm - 24pz	231
CUT2L9	tagliapasta ovale liscio	280	FLOWER 5	chiodi per fiori d. 40 mm - 24pz	231
CUT30L7	kit 7 pz. tagliapasta liscio goccia	280	FLOWER 6	chiodi per fiori d. 36 mm - 24pz	231
CUT31L7	kit 7 pz. tagliapasta liscio stella	280	FLU01	flute in plastica trasparente	337
CUT3L7	kit 7 pz. tagliapasta liscio esagonale	278	FONTANINA	fontana ad acqua per alzate	394

FW001.00	forchettina trasp.	344
FW001.00/100	forchettina trasp.	344
FW001.01	forchettina bianca	344
FW001.01/100	forchettina bianca	344
FW001.02	forchettina nera	344
FW001.02/100	forchettina nera	344
FW0011000	forchettina trasp.	344
FW002.00	cucchiaino trasp.	344
FW002.00/100	cucchiaino trasp.	344
FW002.01	cucchiaino bianco	344
FW002.01/100	cucchiaino bianco	344
FW002.02	cucchiaino nero	344
FW002.02/100	cucchiaino nero	344
FW0021000	cucchiaino trasp.	344
FW003	spiedino corto trasp.	343
FW003/250	spiedino corto trasp.	343
FW0031000	spiedino corto trasp.	343
FW004	spiedino lungo trasp.	343
FW004/250	spiedino lungo trasp.	343
FW0041000	spiedino lungo trasp.	343
FW005.00	spiedino trasp.	345
FW005.00/50	spiedino trasp.	345
FW005.01	spiedino bianco	345
FW005.01/50	spiedino bianco	345
FW005.02	spiedino nero	345
FW005.02/50	spiedino nero	345
FW0052400	spiedino trasparente h 75 mm conf. 24pz	345
FW006.00	spiedino trasp.	345
FW006.00/50	spiedino trasp.	345
FW006.01	spiedino bianco	345
FW006.01/50	spiedino bianco	345
FW006.02	spiedino nero	345
FW006.02/50	spiedino nero	345
FW0062400	spiedino trasparente h 75 mm	345
GD 01 / 22	griglia 60x40 cm	311
GD2/4	griglia speciale taglio 2-4 cm	261
GD3/6	griglia speciale taglio 3-6 cm	261
GIRA	giratorota d. 32 cm h 10 cm	256
GIRA 2	giratorota d. 31 cm h 5.5 cm	256
GIRA 3	giratorota acciaio inox 41x31 cm h 9.5 cm	256
GL 1	manopola da forno 250° c	235
GL 2	manopola da forno polso lungo 250° c	235
GL 3	paio quanto da forno 3 dita 250° c	235
GL 6	guanti in lattice per alimenti	247
GL 7	guanti in lattice per alimenti	247
GL 8	guanti in lattice per alimenti	247
GL 9	guanti in lattice per alimenti	247
GL10	guanti natural grey 27x15 cm	235
GL11	guanti natural grey 34x15 cm	235
GL18PRE	presina da forno 18x25 cm	235
GL25PRE	presina da forno 25x35 cm	235
GPO22	griglia tiramisù 40x30 cm segna porz.	302
GRECA01	forma in gomma 30 cm spessore cm 1	134
GS01 / 22	griglia 30x20	311
GS02	griglia 30x20 fori grandi	311
GST01	kit completo push-up rotondo 100 pz	191
GST02	kit completo push-up cuore 100 pz	191
GST03	kit completo push-up fiore 100 pz	191
GST10	mini push up pops	195
GSTESPO15	espositore satinato split & go 15 pz	193
GSTESPO18	espositore trasparente split & go 18 pz	193
GSTESPO21	espositore satinato split & go 21 pz	193
GSTESPO24	alzatina per push up plex trasp 3 piani	192
GSTESPO36	espositore trasparente push up 36 pz	192
GSTESPO44	espositore trasparente push up pops 44 pz	192
GSTESPOB	espositore bianco split & go 28 pz	193
GSTESPOBM40	espositore mini push bianco 40 sedi	195
GSTESPOM21	espositore mini push satinato	195
GSTESPOM30	espositore mini push trasparente	195
GSTESPOM35	espositore mini push satinato	195
GTB01	griglia tagliabiscotti cuore 60x40 cm	282
GTB02	griglia tagliabiscotti halloween	282
GTB03	griglia tagliabiscotti natale 60x40 cm	282
GTB04	griglia tagliabiscotti pasqua 60x40 cm	282
GTB05	griglia tagliabiscotti fiori/foglie	282
GTB06	griglia tagliabiscotti animali domestici	282
GTB07	griglia tagliabiscotti animali selvatici	283
GTB08	griglia tagliabiscotti frutta 60x40 cm	283
GTB09	griglia tagliabiscotti animali marini	283
GTB10	griglia tagliabiscotti trasporti	283
GTB11	griglia tagliabiscotti carte da gioco	283
GTB12	griglia tagliabiscotti musica 60x40 cm	283
GTB13	griglia tagliabiscotti s.martino	286
GTB14	griglia tagliabiscotti 57x39 cm	284
GTB15	griglia tagliabiscotti 57x39 cm	284
GTB16	griglia tagliabiscotti 57x39 cm	284
GTB17	griglia tagliabiscotti 57x39 cm	284
GTB18	griglia tagliabiscotti 57x39 cm	284
GTB19	griglia tagliabiscotti 57x39 cm	284
GTB20	griglia tagliabiscotti 57x39 cm	285
GTB21	griglia tagliabiscotti 57x39 cm	285
GTB22	griglia tagliabiscotti 57x39 cm	285
GTB23	kit griglia tagliabiscotti 60x40	285
INOX 3	set 3 pz raschietti a pettine inox	251
JUNIOR 01	alzatina coniglietto d. 25 cm h 32 cm	411
JUNIOR 02	alzatina orsetto d. 25 cm h 32 cm	411
JUNIOR 03	alzatina clown d. 25 cm h 32 cm	411
JUNIOR 04	alzatina pinocchio d. 25 cm h 32 cm	411
JUNIOR 05	alzatina coppa d. 25 cm h 32 cm	411
JUNIOR 07	poly junior alzatina piedi	411
JUNIOR 08	poly junior alzatina tartaruga	411
JUNIOR 09	poly junior alzatina coccinella	411
JUNIOR10	poly junior alzatina polipo	411

KIT 1	piatto diam. 48 cm + 4 colonne	405
KIT 2	piatto diam. 68 cm + 6 colonne	405
KITMS1	serie mascherine stencil per cappuccino	303
KITMS2	serie mascherine stencil per cappuccino	303
KITMS3	mascherine cappuccino natale	303
KITMS4	mascherine cappuccino halloween	303
LAMP	lampada per zucchero	246
LAMPLEX	paratia antiventoso acciaio inox	246
LCA000	air brush bianco 190gr	295
LCA001	air brush arancio 190gr	295
LCA002	air brush blu 190gr	295
LCA003	air brush azzurro 190gr	295
LCA004	air brush giallo uovo 190gr	295
LCA005	air brush bruno 190gr	295
LCA006	air brush nero 190gr	295
LCA007N	air brush rosa 190gr	295
LCA008N	air brush rosso 190gr	295
LCA009	air brush verde 190gr	295
LCA010	air brush viola 190gr	295
LCA011	air brush giallo limone 190gr	295
LCA012	air brush verde pistacchio	295
LCA201	air brush pearl arancio 190gr	295
LCA203	air brush pearl azzurro 190gr	295
LCA205	air brush pearl bruno 190gr	295
LCA206	air brush pearl nero 190gr	295
LCA207N	air brush pearl rosa 190gr	295
LCA208N	air brush pearl rosso 190gr	295
LCA209	air brush pearl verde 190gr	295
LCA210	air brush pearl viola 190gr	295
LCA211	air brush pearl giallo limone 190gr	295
LCA212	air brush pearl pistacchio 190gr	295
LCA217	air brush pearl oro 190gr	295
LCA219	air brush pearl argento 190gr	295
LCA300	air brush ciok matt bianco 60 gr	294
LCA303	airbrush ciok mat azzurro 60 gr af	294
LCA304	air brush ciok matt giallo 60 gr	294
LCA307	air brush ciok matt rosa 60 gr	294
LCA308	air brush ciok matt rosso 60 gr	294
LCA309	air brush ciok matt verde 60 gr	294
LCA408	air brush ciok rosso perlato 100 gr	294
LCA417	air brush ciok oro perlato 100 gr	294
LCA419	air brush ciok argento perlato 100 gr	294
LCS100	liquid shiny 100 gr	294
LCB200	burro di cacao bianco 200 gr	298
LCB201	burro di cacao arancio 200 gr	298
LCB202	burro di cacao blu 200 gr	298
LCB204	Burro di cacao giallo 200 gr	298
LCB206	burro di cacao nero 200 gr	298
LCB208	burro di cacao rosso 200 gr	298
LCB209	burro di cacao verde 200 gr	298
LCB210	burro di cacao viola 200 gr	298
LCG001	gel color arancione 30 gr	298
LCG002	gel color blu 30 gr af	298
LCG004	gel color giallo30 gr a	298
LCG005	gel color marrone 30 gr a	298
LCG006	gel color nero 30 gr a	298
LCG007	gel color rosa 30 gr a	298
LCG008	gel color rosso 30 gr a	298
LCG009	gel color verde 30 gr a	298
LCG010	gel color viola 30 gr a	298
LCG022	gel color blue navy barattolo 30 gr	298
LCG025	gel color carne barattolo 30 gr	298
LCI000	color glass secchiello da 1 kg	298
LCI100	color glitter glass secchiello da 1 kg	298
LCP003	polvere perlata azzurro 25 gr	296
LCP008	polvere perlata rosso 25 gr	296
LCP009	polvere perlata verde 25 gr	296
LCP010	polvere perlata viola 25 gr	296
LCP015	polvere perlata bronzo 25gr	296
LCP017N	polvere perlata oro lustre 25 gr	296
LCP018	polvere perlata rubino 25 gr	296
LCP019N	polvere perlata argento lustre 25 gr	296
LCP020	polvere perlata rame 25 gr	296
LCP021	polvere perlata fucsia 25 gr	296
LCP117	polvere perlata oro 25 gr	296
LCP119	polvere perlata argento scuro 25 gr	296
LCP202	Polvere blu 25 gr	297
LCP204	polvere giallo 25 gr	297
LCP206	polvere nero 25 gr	297
LCP208	polvere rosso corallo 25 gr	297
LCP209	polvere verde 25 gr	297
LCP211	polvere arancione 25 gr	297
LCP218	polvere rosso fragola 25 gr	297
LCP300	polvere lacca bianco 25 gr	297
LCP302	polvere lacca blu 25 gr	297
LCP304	polvere lacca giallo 25 gr	297
LCP305	polvere lacca bruno 25 gr	297
LCP306	polvere lacca carbone 25 gr	297
LCP307	polvere lacca rosa 25 gr	297
LCP308	polvere lacca rosso corallo 25 gr	297
LCP308N	polvere lacca rosso 25 gr	297
LCP309	polvere lacca verde 25 gr	297
LCP311	polvere lacca arancione 25 gr	297
LCS001	spray arancio 100 ml	293
LCS003	spray azzurro 100 ml	293
LCS004	spray giallo 100 ml	293
LCS005	spray marrone 100 ml	293
LCS007	spray rosa 100 ml	293
LCS008	spray rosso 100 ml	293
LCS009	spray verde 100 ml	293
LCS200	shiny vernice spray 400 ml	299
LCS215	spray perlato bronzo 100 ml	293
LCS217N	spray perlato oro brillante 100 ml	293

LCS218N	spray perlato rubino 100 ml	293
LCS219N	spray perlato argento 100 ml	293
LCS220	spray perlato rame 100 ml	293
LCV000	spray velvet bianco 400 ml	292
LCV001	spray velvet arancio 400 ml	292
LCV003	spray velvet azzurro 400 ml	292
LCV004	spray velvet giallo 400 ml	292
LCV005N	spray velvet cioccolato al latte 400 ml	292
LCV008	spray velvet rosso 400 ml	292
LCV009N	spray velvetverde mela 400 ml	292
LCV015N	spray velvet cioccolato fondente 400 ml	292
LCV100	marzapane shiny spray 400 ml	299
LCV107	spray velvet fucsia 400 ml	292
LPR 1	lastra ruvida corteccia	137
LPR 2	lastra ruvida piramide	137
LPR 3	lastra ruvida rigato	137
LPR 4	lastra ruvida nido d'ape	137
MA1002-MA2007	stampo cioccolato policarbonato	17-21
MA1956	stampo gallina	45
MA1957	stampo pulcino	45
MA3000-MA3004	stampo cioccolato policarbonato	58
MA4000	kit 2 stampi cioc vintage abajour + telefono	25
MA4001	kit 2 stampi cioc vintage macchina fot. e valigia	25
MA4002	kit 2 stampi cioc vintage juke box + poltrona	25
MA4003	kit 2 stampi cioc vintage sveglia+bilancia	25
MAC000	angeli con candela h 80 mm 3 pz	55
MAC001S	angeli con candela h 125 mm 2 pz	55
MAC002S	st. cioccolato angioletto 3d	55
MAC020	angelo c/bambi h 95 mm 3 pz	55
MAC110	babbo natale c/sacco h 204 mm 1 pz	53
MAC120	babbo natale c/sacco h 110 mm 4 pz	53
MAC122S	babbo natale con sacco h 140 mm 4 pz	53
MAC123	babbo natale c/sacco h 190 mm 2 pz	53
MAC125	babbo natale c/sacco h 320 mm 1 pz	53
MAC130S	babbo natale c/cerbiatto h 122 mm 3 pz	53
MAC131	babbo natale c/bambi h 157 mm 2 pz	53
MAC140S	babbo natale c/cerbiatto h 180 mm 1 pz	53
MAC150	babbo natale c/bambino h 140 mm 1 pz	53
MAC151	babbo natale c/bambino h 220 mm 1 pz	53
MAC161	babbo natale c/doni h 110 mm 3 pz	53
MAC162	babbo natale c/doni h 140 mm 1 pz	53
MAC163	babbo natale c/doni h 220 mm 1 pz	53
MAC164	babbo natale c/doni h 310 mm 1 pz	53
MAC170S	st. cioccolato babbo natale con sacco 3d	52
MAC180	babbo natale c/sacco e orso	53
MAC190S	babbo natale c/sacco e regali h 140 mm	53
MAC200S	babbo natale c/motocicletta	53
MAC220	babbo natale grande h 475 mm 1 pz	55
MAC230	babbo natale piccolo h 95 mm 1 pz	54
MAC240S	st. cioccolato babbo natale con doni 3d	52
MAC260	babbo natale c/sacco h 92 mm 4 pz	54
MAC261	babbo natale h 245 mm 1 pz	54
MAC270	babbo natale motoslitte h 125 mm 1 pz	54
MAC271	babbo natale motoslitte h 200 mm 1 pz	54
MAC281S	st. cioccolato orso babbo natale 3d	52
MAC300	pinguino con sciarpa h 230 mm 1 pz	54
MAC310S	pupazzo di neve h 100 mm 2 pz	54
MAC311	pupazzo di neve h 165 mm 1 pz	54
MAC320S	pupazzo di neve h 114 mm 3 pz	52
MAC321S	pupazzo di neve h 155 mm 1 pz	52
MAC322S	st. cioccolato scarpa calcio 3d	57
MAC323S	st. cioccolato pallone calcio 3d	57
MAC324S	st. cioccolato zucca piccola halloween 3d	56
MAC325S	st. cioccolato zucca simpatica 3d	56
MAC326S	stampo cioccolato scarpa da donna	57
MAC327S	stampo scarpa bimbo converse	57
MAC328S	stampo scarponcino	57
MAC329S	stampo stivaletto uggy	57
MAC400	candela grande h 415 mm 1 pz	55
MAC401S	stampo babbo natale grande	52
MAC402S	stampo pupazzo neve grande	52
MAC403S	stampo albero natale grande	52
MAC404S	stampo candela grande	52
MAC405S	stampo gatto grande	56
MAC406S	stampo zucca grande	56
MAC410S	st. cioccolato presepe 3d	55
MAC420	stivale h 130 mm 1 pz	54
MAC421S	st. cioccolato scarpone 3d	54
MAC440	slitta h 150 mm 1 pz	54
MAC441	slitta h 205 mm 1 pz	54
MAC500	san nicola h 110 mm 3 pz	55
MAC501	san nicola h 140 mm 2 pz	55
MAC502	san nicola h 170 mm 2 pz	55
MAC503	san nicola h 240 mm 1 pz	55
MAC504	san nicola h 320 mm 1 pz	55
MAC510	san nicola a cavallo h 110 mm 3 pz	55
MAC511	san nicola a cavallo h 140 mm 2 pz	55
MAC513	san nicola a cavallo h 235 mm 1 pz	55
MAC521	san nicola c/bambini h 180 mm 1 pz	55
MAC522	san nicola c/bambino h 225 mm 1 pz	55
MAC523	san nicola c/bambino h 255 mm 1 pz	55
MAC600	coniglio in piedi h 200 mm 1 pz	48
MAC601	coniglio in piedi h 200 mm 1 pz	48
MAC602S	stampo cioccolato pulcinotto su cestino big	47
MAC603S	stampo cioccolato agnello con campana big	47
MAC604S	stampo cioccolato coniglio con salopette big	47
MAC610S	coniglietti nel cestino h 180 mm 1 pz	48
MAC611S	stampo cioccolato paperotto con fiocco 3d	46
MAC612S	stampo cioccolato gallinella stupita 3d	47
MAC613S	stampo cioccolato coniglietto su cestino 3d	47
MAC614S	stampo cioccolato coniglietto su cono 3d	47
MAC620S	coniglietto baby con pannolone	48
MAC630S	coniglio "i love you" h 235 mm 1 pz	48

MAC640	coniglio accucciato h 185 mm 1 pz	48
MAC650	coniglio che abbraccia gallina	48
MAC660	coniglio che spinge cesto h 110 mm 1 pz	48
MAC661S	coniglio che spinge cesto h 145 mm 1 pz	48
MAC662	coniglio che spinge cesto h 190 mm 1 pz	48
MAC670S	coniglio che spinge pulcino	49
MAC683	coniglio con bocca aperta h 120 mm 4 pz	49
MAC686	coniglio con bocca aperta h 275 mm 1 pz	49
MAC687	coniglio con bocca aperta h 360 mm 1 pz	49
MAC690	coniglio con braccio alzato	49
MAC691	coniglio braccio alzato h 320 mm 1 pz	49
MAC710	coniglio con cuore h 220 mm 1 pz	49
MAC720S	coniglio e pulcino c/guscio h 170 mm	49
MAC721	coniglio e pulcino c/guscio h 220 mm	49
MAC722	coniglio e pulcino c/guscio h 360 mm	49
MAC730	coniglio gigante c/cesto h 480 mm 1 pz	51
MAC740	coniglio papero e paperello	49
MAC750	coniglio sdraiato h 110 mm 3 pz	49
MAC760S	coniglio spinge uovo gigante	49
MAC770	coniglio su ovetto h 110 mm 3 pz	49
MAC800S	gallina simpatica h 160 mm 2 pz	50
MAC801S	gallina simpatica h 205 mm 1 pz	50
MAC802	gallina simpatica h 68 mm 3 pz	50
MAC810	gallina con fiorellini h 60 mm 3 pz	50
MAC820	gallinella nel cesto h 55 mm 4 pz	50
MAC821	gallinella nel cesto h 90 mm 4 pz	50
MAC822S	gallinella nel cesto h 110 mm 1 pz	50
MAC823S	gallinella nel cesto h 160 mm 1 pz	50
MAC824	gallinella nel cesto h 200 mm 1 pz	50
MAC832	gallo h 180 mm 1 pz	50
MAC840	gallo h 170 mm 1 pz	50
MAC841	gallo h 265 mm 1 pz	50
MAC850S	pulcina con cappellino h 125 mm 2 pz	50
MAC860S	pulcino con cappellino h 125 mm 2 pz	50
MAC870S	pulcino esce dal guscio h 110 mm 3 pz	50
MAC880S	pulcino neonato h 145 mm 1 pz	50
MAC900	guscio porta uova h 115 mm 1 pz	51
MAC901	guscio porta uova h 175 mm 1 pz	51
MAC910	cesto h 40 mm 1 pz	51
MAC913	cesto h 55 mm 1 pz	51
MAC920S	papero pasquale 3d	51
MAC950S	campana h 110 mm 1 pz	51
MAC951	campana h 115 mm 1 pz	51
MAC952S	campana h.150 mm 3d	51
MAC953	campana h 150 mm 1 pz	51
MAC954	campana h 190 mm 1 pz	51
MACC001	kit 2 pz stampo cioccolato cornice	65
MACC002	kit 2 pz stampo cioccolato cornice	65
MACL01	kit 13 lastre in plastica per cioccolato	137
MACS001	kit 2 pz stampo cioccolato semisfera	64
MACS002	kit 6 pz stampo cioccolato semisfera	64
MACS003	kit 4 pz stampo cioccolato semisfera	64
MARCUT 1	coltello per marzapane	314
MARSET 6	set marzapane 6pz	314
MASK 1-MASK204	mascherina decorativa	300-302
MASK H1 - H8	mascherina halloween	302
MASK M1 - M26	mascherina geometrica	302
MASK R1 - R43	mascherina varie	302
MC000305	vaschetta in alluminio anodizzato cap. 1,8 lt	12
MC09G	scioglitore cioccolato 1,8 lt col. grigio	12
MC09L	scioglitore cioccolato 1,8 lt col. lilla	12
MC09R	scioglitore cioccolato 1,8 lt col.rosso	12
MC09V	scioglitore cioccolato 1,8 lt col.verde	12
MC100	meltinchoc analogico 3 vasche da 1,5 lt	8
MC101	meltinchoc analogico 1 vasca da 3,6 lt	9
MC102	meltinchoc analogico 1 vasca da 6 lt	9
MC103	meltinchoc analogico 1 vasca da 9 lt	9
MC104	meltinchoc analogico 1 vasca da 13,7 lt	9
MC105	meltinchoc analogico 1 vasca da 1,5 lt	8
MC106	meltinchoc analogico 4 vasche da 1,5 lt	9
MC107	meltinchoc analogico 3 vasche da 0,8 lt	8
MC108	meltinchoc pro 2 vasche da 1,5 lt	8
MCAR	caramellizzatore d. 11,5 cm	247
MCD01	scioglitore digitale per cioccolato 3,5	13
MCD02	scioglitore digitale per cioccolato 6 lt	13
MCD03	scioglitore digitale per cioccolato 9 lt	13
MCD04	scioglitore digitale per cioccolato 13,7	13
MD 2	sostegno per penna aerografa	291
MEL 250	spatola gomma 25 cm	265
MEL 350	spatola gomma 35 cm	265
MEL 450	spatola gomma 45 cm	265
METAL 3	alzata in alluminio 3 piani	409
METAL 4	alzata in alluminio 4 piani	409
METAL 5	alzata in alluminio 5 piani	409
METAL 6	alzata in alluminio 6 piani	409
METAL 7	alzata in alluminio 7 piani	409
METAL 8	alzata in alluminio 8 piani	409
METAL 9	alzata in alluminio 9 piani	409
MEX 250	spatola polyglass 25 cm	266
MEX 300	spatola exoglass 30 cm	266
MEX 400	spatola exoglass 40 cm	266
MEX 500	spatola exoglass 50 cm	266
MFRU 25	frusta con manico 25 cm	248
MFRU 30	frusta con manico 30 cm	248
MFRU 35	frusta con manico 35 cm	248
MFRU 40	frusta con manico 40 cm	248
MFRU 45	frusta con manico 45 cm	248
MFRU 50	frusta con manico 50 cm	248
MIGNON A / B / C	teglie mignon vari modelli	163
MIP	pompette per multi ice	389
MIRO1	multi ice revolution mod. cigno	386
MIRO2	multi ice revolution mod. ancora	386
MIRO3	multi ice revolution mod. delfino	386

MIR04	multi ice revolution mod. conchiglia	386	PC001	pizza cutter 95x250 mm	273
MIR05	multi ice revolution mod. chiave di sol	386	PC002	pizza cutter 95x305 mm	273
MIR07	multi ice revolution mod. sposi	387	PC003	pizza cutter 95x350 mm	273
MIR08	multi ice revolution mod. pesce	386	PC004	pizza cutter 95x400 mm	273
MIR10	multi ice revolution mod. sirena	387	PC100	pizza cutter manico plastica d. 10 cm	273
MIR11	multi ice revolution mod. cavalluccio	387	PC120	pizza cutter manico plastica d. 12 cm	273
MIR12	multi ice revolution mod. poseidone	388	PC55	pizza cutter manico plastica d. 5,5 cm	273
MIR13	multi ice revolution mod. ares	388	PC65	pizza cutter manico plastica d. 6,5 cm	273
MIR16	multi ice revolution mod. apollo	388	PD 1/2	pettine per due colori 70 cm	308
MIR17	multi ice revolution mod. artemide	388	PD 3/4	pettine per due colori 70 cm	308
MIR18	multi ice revolution mod. demetra	388	PD 5/6	pettine per due colori 70 cm	308
MIS01	supporto per pompetta mir01 cigno	389	PD 7/8	pettine per due colori 70 cm	308
MIS02	supporto per pompetta mir02 ancora	389	PD 9/10	pettine per due colori 70 cm	308
MIS03	supporto per pompetta mir03 delfino	389	PD11/12	pettine per tre colori 70 cm	309
MIS05	supporto per pompetta mir05	389	PD13/14	pettine per charlotte 70 cm	308
MIS08	supporto per pompetta mir08 pesce	389	PDM 1/2	pettine per due colori 34 cm	308
MIS11	supporto per pompetta mir11 cavalluccio	389	PDM 13/14	pettine per charlotte 34 cm	308
MIVA01	vassoio trasp. rettangolare 52x76 cm	379	PDM 3/4	pettine per due colori 34 cm	308
MIVA02	vassoio trasp. quadrato 57x57 cm h 8 cm	379	PDM 5/6	pettine per due colori 34 cm	308
MONOP. A / B / C	teglie monoporzioni vari modelli	159-161	PDM 7/8	pettine per due colori 34 cm	308
MRTE	reggi termometro	246	PDM 9/10	pettine per due colori 34 cm	308
MS 1 / MS28	Mascherina spolvero	303	PDS1/2	pettine due colori 17 cm	308
MSC001	scatola cioc. trasp. 5 alveoli	132	PDS13/14	pettine due colori 17 cm	308
MSC002	scatola cioc. trasp. 9 alveoli	132	PDS3/4	pettine due colori 17 cm	308
MSC003	scatola cioc. trasp.12 alveoli	132	PDS5/6	pettine due colori 17 cm	308
MSC004	scatola cioc. trasp.20 alveoli	132	PDS7/8	pettine due colori 17 cm	308
MSC101	scatola cioc. satinata 5 alveoli	132	PDS9/10	pettine due colori 17 cm	308
MSC102	scatola cioc. satinata 9 alveoli	132	PEM20	pennello 20 mm setola naturale	252
MSC103	scatola cioc. satinata 12 alveoli	132	PEM30	pennello 30 mm setola naturale	252
MSC104	scatola cioc. satinata 20 alveoli	132	PEM40	pennello 40 mm setola naturale	252
MSC201	scatola cioc. bordo satinato 6 alveoli	132	PEM50	pennello 50 mm setola naturale	252
MSC202	scatola cioc. bordo satinato 12 alveoli	132	PEM60	pennello 60 mm setola naturale	252
MSC203	scatola cioc. bordo satinato 18 alveoli	132	PEM70	pennello 70 mm setola naturale	252
MSC204	scatola cioc. bordo satinato 24 alveoli	132	PEMS20	pennello 20 mm setola sintetica	252
MSC300	set 3 cubi satinati diverse misure	132	PEMS30	pennello 30 mm setola sintetica	252
MSC400	set 3 cilindri satinati diverse misure	132	PEMS40	pennello 40 mm setola sintetica	252
MSC501	scatola cioc. trasp. serie binari	132	PEMS50	pennello 50 mm setola sintetica	252
MSC502	scatola cioc. trasp. serie binari	132	PEMS60	pennello 60 mm setola sintetica	252
MSCS00225	scatolette in plastica trasp.	132	PEMS70	pennello 70 mm setola sintetica	252
MSCS20125	scatole in plastica trasp.	132	PINZA	pinza da banco	249
MSP 250	spatola gomma a cucchiaino	266	PINZAX1	pinza inox grande	249
MSP 350	spatola gomma cucchiaino	266	PINZAX2	pinza inox media	249
MT101.01	mini vassoio cocktail quad. bianco 20 pz	376	PINZAX3	pinza inox media	249
MT101.02	mini vassoio cocktail quad. nero 20 pz	376	PINZAX4	pinza inox piccola	249
MT103.01	mini vassoio cocktail triang. bianco 20 p	376	PIRAMTP 02	teglia cm 17x40 piramide	165
MT103.02	mini vassoio cocktail triang. nero 20 pz	376	PIRAMTP 03	teglia cm 26x40 piramide	165
MT501	vassoio componibile modello 1	376	PIRAMTP 07	teglia cm 60x40 piramide	165
MT502	vassoio componibile modello 2	376	PM 5AZ	mascherina azalea 5 pz	305
MT504	vassoio componibile modello 4	376	PM 5DA	mascherina dalia 5 pz	305
MT505	vassoio componibile modello 5	376	PM 5ET	mascherina stella 5 pz	305
MT506	vassoio componibile modello 6	376	PM 5FO	mascherina foglia 5 pz	305
MT600	mod. mirror vassoio specchio ottagonale	378	PM 5MA	mascherina margherita 5 pz	305
MT601	mod. mirror vassoio specchio ovale	378	PM 5PA	mascherina papavero 5 pz	305
MT602	mod. mirror vassoio specchio quadrato	378	PM 5PR	mascherina primula 5 pz	305
MT603	mod. mirror vassoio specchio rettangolare	378	PMFORK	stencil forchetta 12 pz 30 cm	304
MT604	mod. mirror vassoio specchio tondo	378	PMKNIFE	stencil coltello 14 pz 30x20 cm	304
MT700	vassoio plastica nero ottagonale	378	PMO07.00	coppetta trasparente cap. 120ml	330
MT701	vassoio plastica nero ovale	378	PMO07.00/25	coppetta trasparente cap. 120ml	330
MT702	vassoio plastica nero quadrato	378	PMO07.01	coppetta bianca cap. 120ml	330
MT703	vassoio plastica nero rettangolare	378	PMO07.01/25	coppetta bianca cap. 120ml	330
MT704	vassoio plastica nero tondo	378	PMO07.02	coppetta nera cap. 120ml	330
MT705	vassoio plastica nero virgola	378	PMO07.02/25	coppetta nera cap. 120ml	330
MT800	mod. bw vassoio bianco/nero ottagonale	379	PMO07/C	coperchio per cond. pmo07	330
MT801	mod. bw vassoio bianco/nero ovale	379	PMO071800	coppetta trasparente cap. 120ml	330
MT802	mod. bw vassoio bianco/nero quadrato	379	PMO08.00	bicchierino trasparente cap. 70 ml	330
MT803	mod. bw vassoio bianco/nero rettangolare	379	PMO08.00/25	bicchierino trasparente cap. 70 ml	330
MT804	mod. bw vassoio bianco/nero tondo	379	PMO08.01	bicchierino bianco cap. 70 ml	330
MTE	caramellometro con gabbia	246	PMO08.01/25	bicchierino bianco cap. 70 ml	330
NSA 25X150 MM	nastro pretagliato h 25 mm	151	PMO08.02	bicchierino nero cap. 70 ml	330
NSA 30X240 MM	nastro pretagliato 30x240 mm	151	PMO08.02/25	bicchierino nero cap. 70 ml	330
NSA 40X240 MM	nastro pretagliato h 40 mm	151	PMO08.05	bicchierino marrone cap. 70 ml	330
NSA CM 60X40	nastro pretagliato h 60 cm	151	PMO08.09	bicchierino verde cap. 70 ml	330
NSA H 25	nastro acetato neutro h 25 mm	151	PMO08.10	bicchierino lilla cap. 70 ml	330
NSA H 30	nastro acetato neutro h 30 mm	151	PMO08.21	bicchierino fucsia cap. 70 ml	330
NSA H 35	nastro acetato neutro h 35 mm	151	PMO081800	bicchierino trasparente cap. 70 ml	330
NSA H 40	nastro acetato neutro h 40 mm	151	PMO09.00	piattino trasparente cap. 20ml	339
NSA H 45	nastro acetato neutro h 45 mm	151	PMO09.00/25	piattino trasparente cap. 20ml	339
NSA H 50	nastro acetato neutro h 50 mm	151	PMO09.01	piattino bianco cap. 20ml	339
NSA H 55	nastro acetato neutro h 55 mm	151	PMO09.01/25	piattino bianco cap. 20ml	339
NSA H 60	nastro acetato neutro h 60 mm	151	PMO09.02	piattino nero cap. 20ml	339
NSA27X20	conf. 50 fogli f.to 267x200 spessore 80 my	151	PMO09.02/25	piattino nero cap. 20ml	339
NSA36X16	conf. 50 fogli f.to 360x163 spessore 80 my	151	PMO09.05	piattino marrone cap. 20ml	339
NSACM30X30	foglio acetato trasp. 30x30 cm cf. 50 pz	151	PMO09.09	piattino verde cap. 20ml	339
P400.01	ciotola plastica da incastro colore	375	PMO09.10	piattino lilla cap. 20ml	339
P400.02	ciotola plastica da incastro colore nero	375	PMO09.21	piattino fucsia cap. 20ml	339
P401.01	piatto triangolare colore bianco	375	PMO092000	piattino trasparente cap. 20ml	339
P401.02	piatto triangolare colore nero	375	PMO1	piattino monoporzione quadrato .	337
P402	piatto liscio colore bianco	375	PMO10.00	piattino trasparente cap. 30 ml	339
P403.01	ciotola triangolare colore bianco	375	PMO10.00/25	piattino trasparente cap. 30 ml	339
P403.02	ciotola triangolare colore nero	375	PMO10.01	piattino bianco cap. 30 ml	339
P404.01	ciotola barchetta colore bianco	375	PMO10.01/25	piattino bianco cap. 30 ml	339
P404.02	ciotola barchetta colore nero	375	PMO10.02	piattino nero cap. 30 ml	339
PALL 1	pallinatore per baci di dama d.15 mm	258	PMO10.02/25	piattino nero cap. 30 ml	339
PALL 2	pallinatore per baci di dama d.19 mm	258	PMO10.05	piattino marrone cap. 30 ml	339
PALL 3	pallinatore per baci di dama d.24 mm	258	PMO10.09	piattino verde cap. 30 ml	339
PBO01.00	porta bicchiere cono singolo trasparente	380	PMO10.10	piattino lilla cap. 30 ml	339
PBO01.01	porta bicchiere cono singolo bianco	380	PMO10.21	piattino fucsia cap. 30 ml	339
PBO01.02	porta bicchiere cono singolo nero	380	PMO101000	piattino trasparente cap. 30 ml conf. 10 pz	339
PBO01P11	porta bicchiere metallo cono 11 posti	380	PMO11.00	coppetta trasparente cap. 50ml	340
PBO01P2	porta bicchiere metallo cono 2 posti	380	PMO11.00/25	coppetta trasparente cap. 50ml	340
PBO07P2	porta coppetta metallo 2 posti	381	PMO11.01	coppetta bianca cap. 50ml	340
PBO07P4	porta coppetta metallo 4 posti	381	PMO11.01/25	coppetta bianca cap. 50ml	340
PBO07P9	porta coppetta metallo 9 posti	381	PMO11.02	coppetta nera cap. 50ml	340

PMO11.02/25	coppetta nera cap. 50ml	340
PMO11.05	coppetta marrone cap. 50ml	340
PMO11.09	coppetta verde cap. 50ml	340
PMO11.10	coppetta lilla cap. 50ml	340
PMO11.21	coppetta fucsia cap. 50ml	340
PMO111500	coppetta trasparente cap. 50ml conf. 15 pz	340
PMO12.00	spoon trasparente cap. 11ml	340
PMO12.00/25	spoon trasparente cap. 11ml	340
PMO12.01	spoon bianco cap. 11ml	340
PMO12.01/25	spoon bianco cap. 11ml	340
PMO12.02	spoon nero cap. 11ml	340
PMO12.02/25	spoon nero cap. 11ml	340
PMO12.05	spoon marrone cap. 11ml	340
PMO12.09	spoon verde cap. 11ml	340
PMO12.10	spoon lilla cap. 11ml	340
PMO12.21	spoon fucsia cap. 11ml	340
PMO122000	spoon trasparente cap. 11ml	340
PMO13.00	piattino trasparente cap. 15 ml	342
PMO13.00/25	piattino trasparente cap. 15 ml	342
PMO13.01	piattino bianco cap. 15 ml	342
PMO13.01/25	piattino bianco cap. 15 ml	342
PMO13.02	piattino nero cap. 15 ml	342
PMO13.02/25	piattino nero cap. 15 ml	342
PMO135000	piattino trasparente cap. 15 ml	342
PMO14.00	piattino trasparente cap. 20ml	342
PMO14.00/25	piattino trasparente cap. 20ml	342
PMO14.01	piattino bianco cap. 20ml	342
PMO14.01/25	piattino bianco cap. 20ml	342
PMO14.02	piattino nero cap. 20ml	342
PMO14.02/25	piattino nero cap. 20ml	342
PMO142000	piattino trasparente cap. 20ml	342
PMO15.00	piattino trio trasp. cap. 30ml	343
PMO15.00/25	piattino trio trasp. cap. 30ml	343
PMO15.01	piattino trio bianco cap. 30ml	343
PMO15.01/25	piattino trio bianco cap. 30ml	343
PMO15.02	piattino trio nero cap. 30ml	343
PMO15.02/25	piattino trio nero cap. 30ml	343
PMO152500	piattino trio trasp. cap. 30ml	343
PMO2	piattino monoporzione tondo .	337
PMO4	piattino monoporzione ovale .	337
PMO5	piattino monoporzione triangolo .	337
PMO6	piattino monoporzione goccia .	337
PMOB001	calice cap. 510 ml conf. 6 pz	382
PMOB002	calice cap. 475 ml conf. 6 pz	382
PMOB003	bicchieri happy hours cap. 510 ml conf. 6 pz	382
PMOCE001	coppetta wave trasp. cap. 50 ml	322
PMOCE0011800	coppetta wave trasp. cap. 50 ml	322
PMOCE002	coppetta wave trasp. cap. 120 ml	322
PMOCE0021200	coppetta wave trasp. cap. 120 ml	322
PMOCO001	coppetta trasparente cap. 70 ml	332
PMOCO001/C	coperchio per pmoco001	332
PMOCO0013000	coppetta trasparente cap. 70 ml conf. 30 pz	332
PMOCO002	coppetta trasparente cap. 120 ml	332
PMOCO002/C	coperchio per pmoco002	332
PMOCO0022500	coppetta trasparente cap. 120 ml	332
PMOCO003	coppetta trasparente cap. 150 ml	332
PMOCO003/C	coperchio per pmoco003	332
PMOCO0032000	coppetta trasparente cap. 150 ml	332
PMOCO004	coppetta trasparente cap. 175 ml	333
PMOCO0042500	coppetta trasparente cap. 175 ml	333
PMOCO005	coppetta trasparente cap. 125 ml	333
PMOCO0052000	coppetta trasparente cap. 125 ml	333
PMOCO006	coppetta trasparente cap. 150 ml	333
PMOCO0062000	coppetta trasparente cap. 150 ml	333
PMOCO007	coppetta trasparente cap. 150 ml	333
PMOCO0072000	coppetta trasparente cap. 150 ml	333
PMOCO008	coppetta greek trasp. cap. 50 ml	324
PMOCO0081800	coppetta greek trasp. cap. 50 ml	324
PMOCO009	coppetta greek trasp. cap. 120 ml	324
PMOCO0093000	coppetta greek trasp. cap. 120 ml conf. 30 pz	324
PMOCO010	coppetta greek trasp. cap. 190 ml	324
PMOCO0102000	coppetta greek trasp. cap. 190 ml	324
PMOCO011	coppetta vela rasp. cap. 85 ml	318
PMOCO0112000	coppetta vela rasp. cap. 85 ml	318
PMOCO012	coppetta vela trasp. cap. 140 ml	318
PMOCO0121800	coppetta vela trasp. cap. 140 ml	318
PMOCO013	coppetta waffle trasp. cap. 70 ml	320
PMOCO0132000	coppetta waffle trasp. cap. 70 ml	320
PMOCO014	coppetta soft ice trasp. cap. 105 ml	321
PMOCO0143000	coppetta soft ice trasp. cap. 105 ml conf. 30 pz	321
PMOCU001	bicchierino cubo trasp. cap. 50 ml	328
PMOCU001.05	bicchierino cubo marrone cap. 50 ml	328
PMOCU001.09	bicchierino cubo verde cap. 50 ml	328
PMOCU001.10	bicchierino cubo lilla cap. 50 ml	328
PMOCU001.21	bicchierino cubo fucsia cap. 50 ml	328
PMOCU001/24	bicchierino cubo trasp. cap. 50 ml	328
PMOCU001/C	coperchio per pmocu001	328
PMOCU0012800	bicchierino cubo trasp. cap. 50 ml	328
PMOCU002	bicchierino cubo trasp. cap. 100 ml	328
PMOCU002/24	bicchierino cubo trasp. cap. 100 ml	328
PMOCU002/C	coperchio per pmocu002	328
PMOCU0021200	bicchierino cubo trasp. cap. 100 ml	328
PMOCU003	bicchierino cubo trasp. cap. 150 ml	328
PMOCU003/24	bicchierino cubo trasp. cap. 150 ml	328
PMOCU003/C	coperchio per pmocu003	328
PMOCU0031000	bicchierino cubo trasp. cap. 150 ml	328
PMOJA001	coppetta japan trasp. cap. 47 ml	316
PMOJA0011600	coppetta japan trasp. cap. 47 ml	316
PMOJA002	coppetta japan trasp. cap. 87 ml	316
PMOJA0021500	coppetta japan trasp. cap. 87 ml	316
PMOTO001	bicchierino tondo trasp. cap. 50 ml	326
PMOTO001.05	bicchierino tondo marrone cap. 50 ml	326
PMOTO001.09	bicchierino tondo verde cap. 50 ml	326

PMOTO001.10	bicchierino tondo lilla cap. 50 ml	326
PMOTO001.21	bicchierino tondo fucsia cap. 50 ml	326
PMOTO001/24	bicchierino tondo trasp. cap. 50 ml	326
PMOTO001/C	coperchio per pmoto001	326
PMOTO0012000	bicchierino tondo trasp. cap. 50 ml	326
PMOTO002	bicchierino tondo trasp. cap. 80 ml	326
PMOTO002/24	bicchierino tondo trasp. cap. 80 ml	326
PMOTO002/C	coperchio per pmoto002	326
PMOTO0021500	bicchierino tondo trasp. cap. 80 ml	326
PMOTO003	bicchierino tondo trasp. cap. 100 ml	326
PMOTO003/24	bicchierino tondo trasp. cap. 100 ml	326
PMOTO003/C	coperchio per pmoto003	326
PMOTO0031000	bicchierino tondo trasp. cap. 100 ml	326
PMOTO004	bicchierino tondo trasp. cap. 160 ml	326
PMOTO004/24	bicchierino tondo trasp. cap. 160 ml	326
PMOTO004/C	coperchio per pmoto004	326
PMOTO0041200	bicchierino tondo trasp. cap. 160 ml	326
PMOVA001	vasetto terracotta 120 gr	331
PMOVA001.00	coppetta trasparente cap. 120 ml	331
PMOVA002	vasetto terracotta 120 gr	331
PMOVA002.00	coppetta trasparente cap. 120 ml	331
PMOVA003	vasetto terracotta 120 gr	331
PMOVA003.00	coppetta trasparente cap. 120 ml	331
PMSP00N	stencil cucchiaino 12 pz 30 cm	304
POLY 1	espositore cicogna su tetto	411
POLY 6	espositore coniglietto	411
POLY 7	espositore orsetto	411
POLY10	espositore castello due torri	410
POLY11	espositore castello	410
POLY12	espositore palladio con venere	410
POLY14	espositore castello da fiaba	410
POLY17	pinocchio misure 45x51 cm h 65	411
POLY18	alzata clown	411
POLY19	alzata castel novo	411
POMP	pompette per zucchero	246
PORTFLACONE	porta flacone	236
PORTSET	portaordini settimanale	261
PPT 12	porzionatore 12	256
PPT 12/16	Segnaporzioni 12	256
PPT 12/18	Segnaporzioni 12	256
PPT 14/16	Segnaporzioni 14	256
PPT 14/18	segnaporzioni 14	256
PPT 8/12	Segnaporzioni 8-12	256
PPT10X	porzionatore inox 10	256
PPT12X	porzionatore inox 12	256
PPT14X	porzionatore inox 14	256
PPT16X	porzionatore inox 16	256
PPT18X	porzionatore inox 18	256
PPT8X	porzionatore inox 8	256
PR001	piano riscaldante elettrico	134
PR30	piastra raffreddamento d. 30 cm	136
PR30X30	piastra raffreddamento 30x30 cm	136
PR40	piastra raffreddamento d. 40 cm	136
PR40X60	piastra raffred. 40x60 cm c/piedini	136
PR50X50	piastra raffreddamento 50x50 cm	136
PRA 9	set 9 pz tagliap.acciaio per p	281
QG 10	quadro inox 360x360 h 10 mm	134
QG 15	quadro inox 360x360 h 15 mm	134
QG 3	quadro inox 360x360 h 3 mm	134
QG 5	quadro inox 360x360 h 5mm	134
RAS 1	raschia tagliapasta inox 13x10 cm	251
RAS 2	raschia tagliapasta inox 17,5x10 cm	251
RAS 3	raschia tagliapasta inox/steel	251
RAS 4	raschia tagliapasta inox/steel	251
RAS 5	raschia inox 25 cm manico plast. rosso	251
RAS 6	raschia inox 30 cm manico plast. rosso	251
RAS 7	raschia inox 12 cm manico plast. nero	251
RAS 8	raschia inox 20 cm manico plast. nero	251
RC110	raschietto manico rotondo 12x11 cm	136
RC115	raschietto manico rotondo 12x11,5 cm	136
RD105	raschietto manico rotondo 10,5x10,5 cm	251
RD125	raschietto manico rotondo 12,5x10,5 cm	251
RD150	raschietto manico rotondo 15x10,5 cm	251
RD175	raschietto manico rotondo 17,5x10,5 cm	251
RDC180X200	rotolo doppio croissant	272
RELIEF 1	tappeto in rilievo greca grande	306
RELIEF 10	tappeto in silicone fiori/reli	306
RELIEF 11	tappeto in silicone greca quad	306
RELIEF 12	tappeto in silicone maiolica	306
RELIEF 2	tappeto in rilievo tondi	306
RELIEF 3	tappeto in rilievo strisce	306
RELIEF 4	tappeto in rilievo greca piccola	306
RELIEF 5	tappeto in rilievo fregio h 3	306
RELIEF 6	tappeto in rilievo musica h 3	306
RELIEF 7	tappeto in rilievo scacchi h 3	306
RELIEF 8	tappeto in rilievo frutta h 3	306
RELIEF 9	tappeto in rilievo cuori	306
RETH4	rettangolo fisso 58x38 cm h 4 cm 15/10	167
RETH5	rettangolo fisso 58x38 cm h 5 cm 15/10	167
RETSPECIAL 1	rettangolo mobile h 4 cm	167
RETSPECIAL 2	rettangolo mobile h 5 cm	167
RFP 12	rotolo forapasta 12 cm	271
RFP 6	rotolo forapasta 6 cm	271
RFP12INOX	rotolo fora pasta 12 cm	271
RIGA64	righe 12 cm con 7 divisioni da 8 cm	261
RIGAKIT	due righe per teglie 60x40 cm	261
RKS 10	mezza sfera d. 7,5 cm h 5 cm	151
RKS 20	mezzasfera d. 7,5 cm h 5 cm 20 pz	151
RL 1	rotolo fisso 50 cm d. 7 cm	270
RL 2	rotolo fisso 50 cm d. 9 cm	270
RL 3	rotolo fisso 60 cm d. 7 cm	270
RL 4	rotolo fisso 60 cm d. 9 cm	270
RLS 30	rotolo girevole 30 cm d. 9 cm	270

RLS 35	rullo girevole 35 cm d. 9 cm	270
RLS 40	rullo girevole 40 cmd. 9 cm	270
RLS 45	rullo girevole 45 cm d. 9 cm	270
RLS 50	rullo girevole 50 cm d. 9 cm	270
RLS 60	rullo girevole 60 cm d. 9 cm	270
RLS50PE	rullo girevole polietilene 50 cm	270
RLS60PE	rullo girevole polietilene 60 cm	270
RLS70PE	rullo girevole polietilene 70 cm	270
RLT 5	rullo tagliapasta 195 mm taglio 5 mm	270
RLT 10	rullo tagliapasta 195 mm taglio 10 mm	270
RLT 15	rullo tagliapasta 195 mm taglio 15 mm	270
RO 1	mascherina ro 1	302
RO 10	mascherina ro 10	302
RO 12	mascherina ro 12	302
RO 14	mascherina ro 14	302
RO 15	mascherina ro 15	302
RO 4	mascherina ro 4	302
RO 6	mascherina ro 6	302
ROLL H 30	rotolo sacchetti 100 pz h 30 cm	223
ROLL H 40	rotolo sacchetti 100 pz h 40 cm	223
ROLL H 55	rotolo sacchetti 100 pz h 55 cm	223
ROLL H 65	rotolo sacchetti 100 pz h 65 cm	223
ROLLER	distributore per sacchetti in rotolo	225
ROTAPINOX 5 O	tagliapasta est. inox 5 elementi	273
ROTAPINOX 5 P	tagliapasta est. inox 5 elementi lisci	273
ROTAPINOX 7 O	tagliapasta est. inox 7 elementi	273
ROTAPINOX 7 P	tagliapasta est. inox 7 elementi lisci	273
ROTINOX 5 P/O	tagliapasta est. inox 5 elementi	273
ROTINOX 7 P/O	tagliapasta est. inox 7 elemen	273
RPL 12	rullo per losanghe 12 cm	271
RPL 6	rullo per losanghe 6 cm	271
RPL12INOX	rullo per losanghe 12 cm	271
RPS 6	rullo per strudel 6 cm	271
RSC110X150	rullo singolo croissant 110x150 mm	272
RSC180X140	rullo singolo croissant 180x140 mm	272
RSC180X200	rullo singolo croissant 180x200 mm	272
RSC97X210	rullo singolo croissant 97x210 mm	272
RTA 1	raschietto rta1 rigido	250
RTA 2	raschietto rta2 morbido	250
RTC180X200	rullo triplo croissant 180x200 mm	272
RTD 1	raschietto rtd1 rigido	250
RTF 1	raschietto rtf1 rigido	250
RTF 2	raschietto rtf2 morbido	250
RTKIT	kit raschietti in plastica 4 pz misti	250
RTL 1	raschietto rtl1 rigido	250
RTL 2	raschietto rtl2 morbido	250
RTO 1	raschietto ovale	250
RTO 2	raschietto ovale	250
RTP 1	raschietto rtp 1 rigido	250
RTP 2	raschietto rtp 2 morbido	250
RTRA 1	raschietto trasparente per decorazioni	198
RTRA 2	raschietto trasparente per decorazioni	198
RTRA 3	raschietto trasparente per decorazioni	198
RTRA 4	raschietto trasparente per decorazioni	198
RTRA 5	raschietto trasparente per decorazioni	198
RTRA1-5	kit 5 pz raschietti decoro	198
RTS 1	raschietto tipo semicerchio	250
RTT 1	raschietto tipo trapezio	250
RTV 1	raschietto rtv1 stampato a 2 impronte	250
RTV 2	raschietto rtv2 stampato a 2 impronte	250
SAC 100	sacchetto monouso 17x30 cm conf.100 pz	224
SAC 25	sacchetto monouso 30x50 cm	224
SAC 50	sacchetto monouso 30x50 cm	224
SAC45X100	conf 100 sac a poche tagliati triangolo misura 45 circa	224
SAC58X100	conf 100 sac a poche tagliati triangolo misura 58 circa	224
SBKIT01	kit baby ice 8 mod. x 10 pz	188
SC196GR	stampo cottura inox cod. 196	407
SC196PI	stampo cottura inox cod. 196	406
SCA 10	mattarello per scanalare 195 mm	270
SCA 15	mattarello per scanalare 195 mm	270
SCC01	stampo calamita cioccolato cucchiaino	43
SCI01	stampo cottura inox per base cod.111/112	395
SCI02	stampo cottura inox cod.111 d.48 cm	395
SCI03	stampo cottura inox cod.122	397
SCI04	stampo cottura inox cod.116 set 4pz	398
SCI07	stampo cottura inox base cod.118/f	395
SCI09	stampo cottura inox base cod.155 d.68 cm	405
SCI10	stampo cottura inox cod.155 d.48 cm	405
SCM 30	spatola con manico 30 cm	265
SCM 35	spatola con manico cm 35	265
SCM 40	spatola con manico cm 40	265
SCSP01	stencil cucchiaini grandi 130x30 mm h 2 mm	305
SCSP03	stencil cucchiaini piccoli 75x35 mm h 2 mm	305
SCSP04	stencil goccia 65x40 mm h 2 mm	305
SEG 001	segnaprezzo ventaglio 25 pz.	275
SEG 002	segnaprezzo pizzo 25 pz	275
SEG 003	segnaprezzo cuore 30 pz	275
SEG 004	segnaprezzo ovalino 30 pz	275
SEG 005	segnaprezzo quadrato piccolo 50 pz.	275
SEG 006	segnaprezzo quadrato medio 25 pz.	275
SEG 008	segnaprezzo margherita 25 pz.	275
SEG 015	segnaprezzo flash 50 pz.	275
SEG 021	segnaprezzo fiori mod. quadrato 25 pz.	275
SEG 022	segnaprezzo con mano	275
SEG 023	segnaprezzo fiori mod. rombo conf. 15 pz	275
SEG 024	segnaprezzo margherita .	275
SEG 025	segnaprezzo nuvola .	275
SEG 026	segnaprezzo fiore mod. tondo	275
SEG 027	segnaprezzo angelo conf. 15 pz	275
SES 1500	sessola/flour scoop 1520 ml	239
SES 100	sessola/flour scoop 100 ml	239
SES 250	sessola/flour scoop 250 ml	239
SES 500	sessola/flour scoop 512 ml	239

SES 800	sessola/flour scoop 857 ml	239
SET DISK	serie otto dischi sottotorta	260
SETAC 16	setaccio inox	254
SETAC 19	setaccio inox	254
SETAC 21	setaccio inox	254
SETAC 24	setaccio inox	254
SETAC 26	setaccio inox	254
SETAC 28	setaccio inox	254
SETAC 30	setaccio inox	254
SETACIOK	spargi cacao mini setaccio h 9 cm	303
SF 3	set semisfere 3z	151
SF001 - SF061	multiforma in silicone	175-177
SFT 118/Y / 730/Y	tortiera in silicone	174-175
SG 01	st. gelatine 45x18x15 n.24 fette arancio	180
SG 02	st.gelatine 40x26x15 n.24 pera	180
SG 03	st.gelatine 34x30x18 n.24 cuore	180
SG 04	st.gelatine d.27xh.13.5 n.24 mezzasfera	180
SG 05	st.gelatine d.30xh11 n.24 bon bon	180
SG 06	st.gelatine d.30xh.24 n.24 mora	180
SG 07	st.gelatine 33x23x18 n.24 ananas	180
SG 08	st.gelatine 36x30x20 n.24 fragola	180
SG 09	st.gelatine 35x25x20 n.24 pesca	180
SGM001	spatola gelato arancione	201
SGM002	spatola gelato blu	201
SGM003	spatola gelato bianca	201
SGM004	spatola gelato gialla	201
SGM007	spatola gelato rosa	201
SGM008	spatola gelato rossa	201
SGM009	spatola gelato verde	201
SGM100	spatola gelato con manico in legno	201
SILICOPAT1/B	silicopat 39,5x59,5 cm bianco	232
SILICOPAT1/R	silicopat standard 59,5x39,5 cm rosso	232
SILICOPAT2/B	silicopat 31x51 cm bianco	232
SILICOPAT2/R	silicopat colore rosso 51x31 cm	232
SILICOPAT3/B	silicopat 62x42 cm bianco	232
SILICOPAT4/B	silicopat big 79x59 cm bianco	232
SILICOPAT5/R	silicopat 27x42 cm rosso	232
SILICOPAT6/R	silicopat 36x43 cm rosso	232
SILICOPAT7/R	silicopat 30x40 cm rosso	232
SKB 10	mezza cono d. 6,5 h6	151
SKB 20	mezzo cono d.6,5 cm h 6 cm pz 20	151
SM 1000	stampo cioccolato mod. uovo	71
SM 2000	stampo cioccolato mod. uovo	71
SM 2300	uovo doppio liscio	71
SM 2500	stampo cioccolato mod. uovo	71
SM 3000	stampo cioccolato mod. uovo	71
SM 3500	stampo cioccolato mod. uovo	71
SM 4000	stampi cioccolato mod. uovo	71
SMA110	stampo san martino monoporzione	286
SMA180	stampo san martino piccolo	286
SMA260	stampo san martino medio	286
SMA320	stampo san martino grande	286
SPA16	spatola inox 16 cm manico plast.	267
SPA21	spatola inox 21 cm manico plast.	267
SPA26	spatola inox 26 cm manico plast.	267
SPA31	spatola inox 31 cm manico plast.	267
SPA36	spatola inox 36 cm manico plast.	267
SPANG 16	spatola angolare inox cm 16	267
SPANG 21	spatola angolare inox cm 21	267
SPANG 26	spatola angolare inox cm 26	267
SPANG 29	spatola angolare	266
SPANG 31	spatola angolare inox cm 31	267
SPANG 39	spatola angolare	266
SPB	spatola/knife per biscuit	255
SPB SPECIAL	racla regolabile inox	255
SPB40	spatola plastica mini	218
SPBMINI	spatola plastica per mini chitarra	255
SPEEDY 1	stampo mignon marzapane tondo	315
SPEEDY 3	stampo mignon marzapane goccia	315
SPEEDY 4	stampo mignon marzapane cuore	315
SPPEDY 2	stampo mignon marzapane ovale	315
SPR034	sac a poche superflex 34 cm	220
SPR034/C	sac a poche superflex 34 cm c/cavallotto	220
SPR045	sac a poche superflex 45 cm	220
SPR045/C	sac a poche superflex 45 cm c/cavallotto	220
SPR050	sac a poche superflex 50 cm	220
SPR050/C	sac a poche superflex 50 cm c/cavallotto	220
SPZ INOX	spazzola/brush 14,5x5,5 cm	253
SPZ PL1	spazzola 24x7,5 cm	253
SPZ PL2	spazzola 21x6,5 cm	253
SPZ PL3	spazzola 40x4 cm	253
SPZ SE	spazzolone legno 40x4 cm	253
SS001-SS38	kit 2 stampi semifreddi grande/piccolo	153-155
SSM024/3	conf. 3 pz stampo semifreddo monop.	156
SSM025/3	stampo semifreddo monop. conf. 3 pz	156
SSM026/3	conf. 3 pz stampo semifreddo monop.	156
SSM027/3	conf. 3 pz stampo semifreddo monop.	156
SSM028/3	conf. 3 pz. stampo semifreddo monop.	156
SSM029/3	conf. 3 pz stampo semifreddo monop.	157
SSM030/3	conf. 3 pz. stampo semifreddo monop.	157
SSM031/3	conf. 3 pz stampo semifreddo monop.	157
SSM032/3	conf. 3 pz stampo semifreddo monop.	157
SSM033/3	conf. 3 pz stampo semifreddo monop.	157
SSM034/3	conf. 3 pz stampo semifreddo monop.	157
SSM035/3	conf. 3 pz. stampo semifreddo monop.	157
SSM036/3	conf. 3 pz. stampo semifreddo monop.	157
SSM037/3	conf. 3 pz. stampo semifreddo monop.	157
SSM038/3	conf. 3 pz stampo semifreddo monop.	157
ST 1	stampo per tronco triangolo	150
ST 2	stampo per tronco semicerchio	150
ST 3	stampo per tronco fantasia	150
ST 4	stampo per tronco semicerchio	150
ST 7	stampo tronchetto piccolo+st.flessibile	150

ST 8	st. tronchetto grande +st. flessibile	150	TFP 20	teglia con foro 20 cm	254
ST 9	stampo tronchetto piccolo +	150	TFP 22	teglia con foro 22 cm	254
ST N1	stampo per tronco triangolo 48x6,5 n7	150	TFP 24	teglia con foro 24 cm	254
ST N2	stampo per tronco semicerchio 48x6,5 h7	150	TFP 26	teglia con foro 26 cm	254
ST N3	stampo per tronco fantasia 48x6,5 h7	150	TFP 8	teglia con foro 8 cm	254
STD 025 CM	sacchetto standard 25 cm	221	TFRU 25	frusta con manico 25 cm	248
STD 028 CM	sacchetto standard 28 cm	221	TFRU 30	frusta con manico 30 cm	248
STD 034 CM	sacchetto standard 34 cm	221	TFRU 35	frusta con manico 35 cm	248
STD 040 CM	sacchetto standard 40 cm	221	TFRU 40	frusta con manico 40 cm	248
STD 046 CM	sacchetto standard 46 cm	221	TFRU 45	frusta con manico 45 cm	248
STD 050 CM	sacchetto standard 50 cm	221	TFRU 50	frusta con manico 50 cm	248
STD 055 CM	sacchetto standard 55 cm	221	TL 02	telajo per biscuit 60x40 cm h 2 mm	255
STD 060 CM	sacchetto standard 60 cm	221	TL 03	telajo per biscuit 60x40 cm h 3 mm	255
STD 065 CM	sacchetto standard 65 cm	221	TL 04	telajo per biscuit 60x40 cm h 4 mm	255
STD 070 CM	sacchetto standard 70 cm	221	TL 05	telajo per biscuit 60x40 cm h 5 mm	255
STD 075 CM	sacchetto standard 75 cm	221	TL 15	telajo inox per charlotte	255
STLG100	stecchi in legno per gelato	185	TLM03	telajo mini h 3 mm per tmini	218
STPK	stampo kaiser a rotazione manuale	268	TLM05	telajo mini h 5 mm per tmini	218
STPTA 1	stampo pane tartaruga quadrato	269	TLMINI	kit base+4telai per ganaches	218
STPTA 10	stampo per pane pierino 1	268	TLS03	telajo per cremini sp. 3 mm	218
STPTA 11	stampo per pane pierino 2	268	TLS05	telajo per cremini sp. 5 mm	218
STPTA 12	stampo per pane pierino 3	268	TLSPECIAL	telajo per cremini - kit cremino	218
STPTA 13	stampo per pane pierino 4	268	TPEX 1	tagliapasta extra d.80 h 40 inox	164
STPTA 14	stampo per pane pierino 5	268	TPG 01 - 15	tagliapasta mono tondo d.60 h45 mm	159-161
STPTA 2	stampo pane tartaruga esagonale	269	TPGSET	set 9 tagliapasta diam. 65 mm	287
STPTA 3	stampo pane sole/bread mould	269	TPGSET/2	set 7 tagliapasta d. 65 mm in plastica	287
STPTA 4	stampo pane pannocchia/bread m	269	TPM 1 - 9	tagliapasta mignon	163
STPTA 5	stampo pane margherita/bread m	269	TPMSET	set 9 tagliapasta diam. 40 mm	287
STPTA 6	stampo per pane kaiser	268	TPP 60X40	tavola in plastica cm 60x40 h 8 mm	413
STPTA 7	stampo per pane kaiser c/foro	268	TPSET4	set topi/set mice	151
STPTA 8	stampo per pane girella	268	TS1	paletta da dolce d. 28 cm	267
STPTA 9	stampo per pane pierino	268	VASSOIOAMI	vassoio plastica 20x40 mignon	263
STPZ	stampo in plastica zucca	268	VASSOIOAMO	vassoio plastica 17x40 monoporzione	263
SUGAR 1	manuale per principianti	312	VASSOIOBMI	vassoio plastica 30x40 mignon	263
SUP001	porta bicchierini	336	VASSOIOBMO	vassoio plastica 26x40 monoporzione	263
SUP003	porta bicchierini	336	VASSOIOCM1	vassoio plastica 59x39 mignon h 1,5	263
SUP004	porta bicchierini	336	VASSOIOCMO	vassoio plastica 60x40 monoporzione	263
SUT25X17	stampo cioccolato 1/2 guscio trasparente	59	VB00102	porta brioches trasp.	240
SUT28X18	stampo cioccolato 1/2 guscio trasparente	59	VB00103	vetrina porta brioches trasp.	240
SUT34X25	stampo cioccolato 1/2 guscio trasparente	59	VB00104	vetrina porta brioches trasp.	240
SUT40X27	stampo cioccolato 1/2 guscio trasparente	59	VB00105	vetrina porta brioches riscaldante	241
SUT45X32	stampo cioccolato 1/2 guscio trasparente	59	VB00106	vetrina porta brioches riscaldante	241
SUT54X36	stampo cioccolato 1/2 guscio trasparente	59	VB00107	vetrina brioches base acciaio neutra 1 piano	241
SUT64X43	stampo cioccolato 1/2 guscio trasparente	59	VB00108	vetr. brioches base acciaio riscaldante 1 piano	241
SUT75X50	stampo cioccolato 1/2 guscio trasparente	59	VB00109	vetrina brioches base acciaio neutra 2 piani	241
T6 O4	teglia torta mod.ottagonale h 4 cm	165	VB00110	vetr. brioches base acciaio riscaldante 2 piani	241
T6 O5	teglia torta mod.ottagonale	165	VB00200	porta brioches laterali bianchi	240
T6 R4	teglia torta mod.rotondo h 4 cm	165	VB00201	porta brioches laterali trasparenti	240
T6 R5	teglia torta mod.rotondo	165	VB00202	porta brioches laterali verdi	240
TAG 4	tagliere 40x30 cm	260	VB00203	porta brioches laterali arancioni	240
TAG 5	tagliere 50x30 cm	260	VB00206	porta brioches laterali satinati	240
TAV 50X50 C/P	tavola 50x50 cm 4 piedini	413	VB00208	porta brioches laterali neri	240
TAV 50X50 PIA	tavola 50x50 cm piana	413	VB00306	vetrina manhattan 3 ripiani	241
TAV 50X60 C/P	tavola 50x60 cm 5 piedini	413	VB00308	vetrina manhattan 3 ripiani	240
TAV 50X60 PIA	tavola 50x60 cm piana	413	VB00408	vetrina manhattan 2 ripiani	241
TAV 59X39	teglia piana 59x39 cm h 8	413	VC30X40	vassoio+coperchio 30x40 cm h 6 cm	263
TAV 60X40 C/P	tavola 60x40 cm 4 piedini	413	VC60X40	vassoio+coperchio cm 60x40 h 6 cm	263
TAV 60X60 C/P	tavola 60x60 cm 5 piedini	413	VC60X404	vassoio+coperchio cm 60x40 h 4,2 cm	263
TAV 60X60 PIA	tavola 60x60 cm piana	413	VC60X408	vassoio+coperchio cm 60x40 h 8,2 cm	263
TAV 60X70 C/P	tavola 60x70 cm 9 piedini	413	VP00101	vetrina porta praline	28
TAV 60X70 PIA	tavola 60x70 cm piana	413	VP00206	base monosat. c/bordi per vetrina	29
TAV 60X80 C/P	tavola 60x80 cm 12 piedini	413	VP00301	ripiano per vetrina trasp.	29
TAV 60X80 PIA	tavola 60x80 cm piana	413	VP00401	base trasp. c/bordi per vetrina	28
TAV 70X70 C/P	tavola 70x70 cm 9 piedini	413	VP00500	base bianca c/bordi per vetrina	29
TAV 70X70 PIA	tavola 70x70 cm piana	413	VP00501	ripiano per vetrina trasp.	28
TAV 70X80 C/P	tavola 70x80 cm 12 piedini	413	VP00601	ripiano trasp. per vetrina	29
TAV 70X80 PIA	tavola 70x80 cm piana	413	VP00700	base bianca c/bordi per vetrina	28
TAV 80X100C/P	tavola 80x100 cm 20 piedini	413	VP00801	ripiano trasp. per vetrina	28
TAV 80X100PIA	tavola 80x100 cm piana	413	VP00906	base monosat. c/bordi per vetrina	29
TAV 80X80 C/P	tavola 80x80 cm 12 piedini	413	VP01001	ripiano trasp. per vetrina	29
TAV 80X80 PIA	tavola 80x80 cm piana	413	VP01106	base monosat. c/bordi per vetrina	29
TAV 80X90 C/P	tavola 80x90 cm 20 piedini	413	VP01201	ripiano trasp. per vetrina	29
TAV 80X90 PIA	tavola 80x90 cm piana	413	VS00101	vassoio in plexiglass 47x34h5 cm	242
TAV 90X90 C/P	tavola 90x90 cm 16 piedini	413	VS00201	vassoio in plexiglass 30x42 h 6,5 cm	242
TAV 90X90 PIA	tavola 90x90 cm piana	413			
TAV D. 40 C/P	tavola d. 40 cm 4 piedini	413			
TAV D. 40 PIA	tavola d. 40 cm piana	413			
TAV D. 50 C/P	tavola d. 50 cm 5 piedini	413			
TAV D. 50 PIA	tavola d. 50 cm piana	413			
TAV D. 60 C/P	tavola d. 60 cm 5 piedini	413			
TAV D. 60 PIA	tavola d. 60 cm piana	413			
TAV D. 70 C/P	tavola d. 70 cm 9 piedini	413			
TAV D. 70 PIA	tavola d. 70 cm piana	413			
TAV D. 80 C/P	tavola d. 80 cm 9 piedini	413			
TAV D. 80 PIA	tavola d. 80 cm piana	413			
TAV D. 90 C/P	tavola d. 90 cm 9 piedini	413			
TAV D. 90 PIA	tavola d. 90 cm piana	413			
TAV D.100 C/P	tavola d. 100 cm 13 piedini	413			
TAV D.100 PIA	tavola d. 100 cm piana	413			
TAV D.120 C/P	tavola d. 120 cm 13 piedini	413			
TAV D.120 PIA	tavola d. 120 cm piana	413			
TC001/5	kit nr. 5 tavolette in plastica mod. 001	65			
TC002/5	kit nr. 5 tavolette in plastica mod. 002	65			
TC003/5	kit nr. 5 tavolette in plastica mod. 003	65			
TEFLONPAT	mod. standard 60x40 cm	232			
TEMAXI	teglia polistirolo 60x40 cm	165			
TFL 10	tampone finto legno 10 cm	309			
TFL 15	tampone finto legno 15 cm	309			
TFP 10	teglia con foro 10 cm	254			
TFP 12	teglia con foro 12 cm	254			
TFP 14	teglia con foro 14 cm	254			
TFP 16	teglia con foro 16 cm	254			
TFP 18	teglia con foro 18 cm	254			

