



Instruction Manual

36, 48, & 60 oz. Cornados

Model Series 2149, 2258, and 2297 (100, 110, and 101, 111)



48 oz. Unit Shown



GOLD MEDAL® PRODUCTS CO.

10700 Medallion Drive, Cincinnati, Ohio 45241-4807 USA



Table of Contents

.....	1
SAFETY PRECAUTIONS	3
INSTALLATION INSTRUCTIONS	5
Inspection of Shipment	5
Manual	5
Model Description	5
Items Included with this Unit	5
Setup	6
Electrical Requirements	8
Before You Plug In Machine	9
OPERATING INSTRUCTIONS	10
Controls and Their Functions	10
Program the E-Z Set Timer	13
Popping Corn Instructions	14
Care and Cleaning	16
Troubleshooting	19
MAINTENANCE INSTRUCTIONS	21
Removing Agitator Assembly and Shaft Maintenance	22
Replacing the Packing Cord on Kettle Hub	23
Kettle and Drive Shaft Alignment	24
Electronic Temperature Control	25
Operation	25
Control Description	25
Programming the Electronic Control	26
Error Conditions for the Electronic Control	27
Kettle Circuit Breaker	28
ORDERING SPARE PARTS	29
Unit Exterior – Front View – Filter	30
Unit Exterior – Rear View - Oil Line	31
Unit Exterior – Kettle Mount – Parts Breakdown	32
Kettle Assembly (36, 48, and 60 oz.) – Parts Breakdown	34
36 oz. Kettle Bottom – Element View	36
48 oz. Kettle Bottom – Element View	37
60 oz. Kettle Bottom – Element View	38
Pedestal Interior – Motor and Shaft	39
Pedestal Interior – Electrical – Parts Breakdown	40
Control Box/Control Panel – Parts Breakdown	42
Safety Labels	43
Accessories	44
Wiring Diagram	45
WARRANTY	46



SAFETY PRECAUTIONS

	⚠ DANGER
	<p>Machine must be properly grounded to prevent electrical shock to personnel. Failure to do so could result in serious injury, or death. DO NOT immerse any part of this equipment in water. DO NOT use excessive water when cleaning. Keep cord and plug off the ground and away from moisture. Always unplug the equipment before cleaning or servicing. Make sure all machine switches are in the OFF position before plugging the equipment into the receptacle.</p> <p>008_051514</p>

	⚠ DANGER
	<p>Improper installation, adjustment, alteration, service, or maintenance can cause property damage, injury, or death. Any alterations to this equipment will void the warranty and may cause a dangerous condition. This appliance is not intended to be operated by means of an external timer or separate remote-control system. NEVER make alterations to this equipment. Read the Installation, Operating, and Maintenance Instructions thoroughly before installing, servicing, or operating this equipment.</p> <p>014_020416</p>

	⚠ WARNING
	<p>To avoid burns, DO NOT touch the kettle or any heated surface. DO NOT place or leave objects in contact with heated surfaces.</p> <p>013_092414</p>



	⚠ WARNING
	<p>ALWAYS wear safety glasses when servicing this equipment.</p> <p>010_010914</p>

	⚠ WARNING
	<p>No user serviceable parts inside. Refer servicing to qualified service personnel.</p> <p>011_051514</p>

	⚠ WARNING
	<p>Read and understand operator's manual and all other safety instructions before using this equipment. To order copies of the operator's manual go to gmpopcorn.com or write to Gold Medal Products Co., 10700 Medallion Drive, Cincinnati, OH 45241 USA 1-(800)-543-0862</p> <p>022_060215</p>



SAFETY PRECAUTIONS (continued)

	 WARNING
	DO NOT allow direct contact of this equipment by the public when used in food service locations. Only personnel trained and experienced in the equipment operation may operate this equipment. Carefully read all instructions before operation. 012_010914

	 WARNING
	This machine is NOT to be operated by minors. 007_010914

Note: Improvements are always being made to Gold Medal's equipment. This information may not be the latest available for your purposes. It is critical that you call Gold Medal's Technical Service Department at 1-800-543-0862 for any questions about your machine operations, replacement parts, or any service questions. (Gold Medal Products Co. does not assume any liability for injury due to careless handling and/or reckless operation of this equipment.) General images may be used in manual for reference only.



INSTALLATION INSTRUCTIONS

Inspection of Shipment

After unpacking, check thoroughly for any damage which may have occurred in transit. Claims should be filed immediately with the transportation company. The warranty does not cover damage that occurs in transit, or damage caused by abuse, or consequential damage due to the operation of this machine, since it is beyond our control (reference warranty in back of manual).

Manual

Read and understand the operator's manual and all other safety instructions before using this equipment. To order copies of the operator's manual go to gmpopcorn.com or write to Gold Medal Products Co., 10700 Medallion Drive, Cincinnati, OH 45241 USA 1-(800)-543-0862.







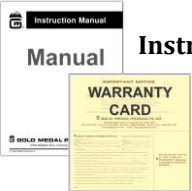

Model Description

This manual covers 2149 (36 oz.), 2258 (48 oz.), and 2297 (60 oz.) Series, tall pedestal, Cornado units (motor is located in pedestal). See below for series specific RH, LH, and Pass Thru Handle descriptions.

Model Series

- 100:** Right Hand Dump
- 110:** Left Hand Dump
- 101:** Right Hand Dump, Pass Thru Handle
- 111:** Left Hand Dump, Pass Thru Handle

Items Included with this Unit

 <p>Instruction Manual Manual Registration Warranty Card</p>	 <p>Corn Cup Unit specific: 36 oz. (PN 67905-36), 48 oz. (PN 17757-48), 60 oz. (PN 17757-60)</p>	 <p>Flavacol Container (PN 41752)</p>
 <p>2 TBS. Flavacol Measure 36 oz. Units (PN 47681)</p>	 <p>1/4 Cup Flavacol Measure 48 and 60 oz. Units (PN 47169)</p>	 <p>RH Jet Scoop (PN 2072)</p>
 <p>NEMA L14-30 Receptacle (PN 82208)</p>	 <p>NEMA 14-50 Receptacle (PN 82920)</p>	



Setup

The Cornado Popper has been inspected and tested at the factory. Installation of the popper should be performed by qualified service personnel. Read and perform all Setup steps prior to operating the unit.

1. Remove all packaging and tape.
2. Install unit on a level surface; the popper must have an 8" minimum clearance required between the popper kettle and any combustibile surface. See counter mounting requirements and hole locations below.

Mounting Instructions

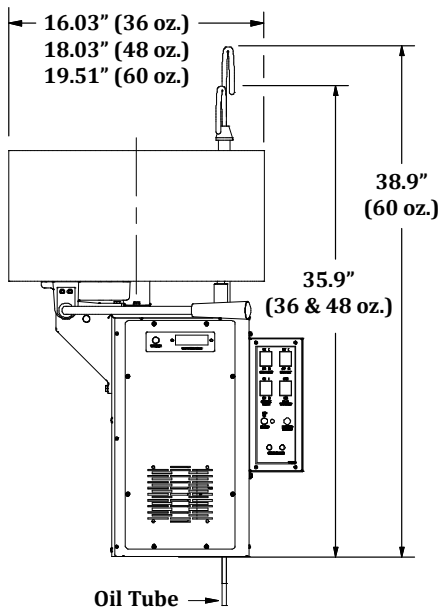

8" minimum clearance required between kettle and any combustibile surface.

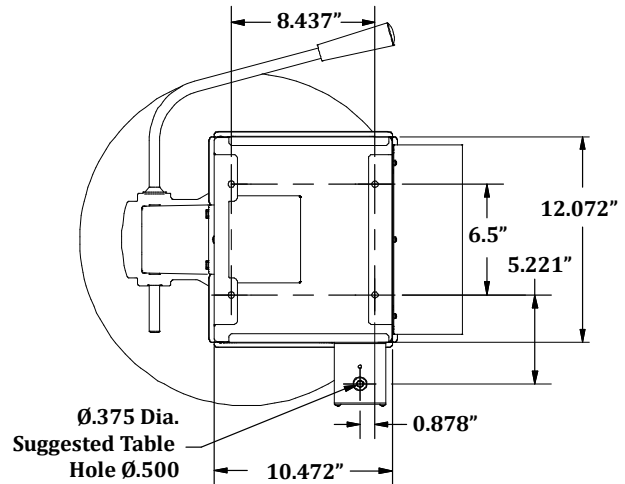

Hole Locations

Remove front panel to access mounting holes on bottom of pedestal interior.

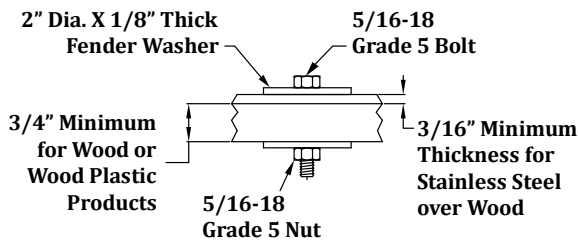

Counter Mounting Requirements

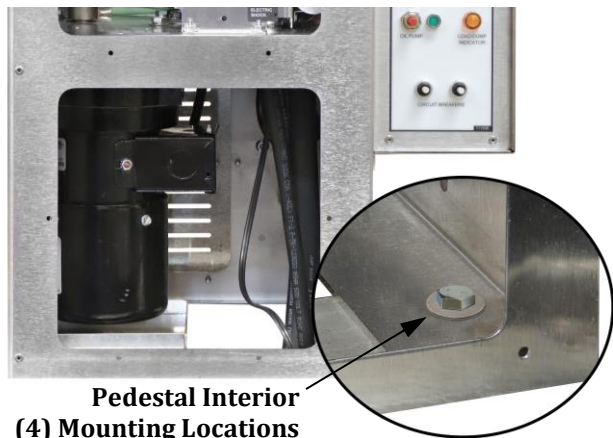

Pedestal Interior (4) Mounting Locations

Secure Pedestal to table or counter.



3. The main power cord extends out the bottom of the cabinet base. A secondary, smaller power cord, is provided for powering the oil dispense unit.

Before plugging in machine, have a certified electrician follow all requirements listed in the Electrical Requirements section of this manual.

4. The small power cord (6 pin Jones Plug) is the oil pump harness which connects the popper to the oil dispense unit. To connect/calibrate the oil dispense system to the popper; refer to the Instruction Manual included with the oil dispense unit (reference the Program the EZ-Set Timer section to set the oil dispense timer(s).
5. After setup, the unit should be cleaned. The kettle has a food grade protective coating applied to the cooking surfaces, this coating must be removed prior to operating the unit (see Care and Cleaning section of this manual).



Electrical Requirements

The following power supply must be provided:

36 oz. Cornado - 2149 Series:



120/208 V~ or 120/240 V~, 5500 W, 60 Hz (watts for 2114 Series Bucket Pump included)

Unit designed to operate on single phase, 30 AMP, 4 wire supply, 120/208 or 120/240 V~ (2 Hot, 1 Neutral, 1 Ground). All electrical components in this machine are 120 V (motors, heat elements, lights, etc.) and therefore require “Hot to Neutral” connection (**NOT** “Hot to Hot”). A 30 AMP wall receptacle (NEMA L14-30) is supplied with the machine. The receptacle will accept the attachment plug on the machine and must be used; reference the Receptacle Wiring Diagram for NEMA L14-30 for receptacle installation instructions.

48 and 60 oz. Cornados - 2258 and 2297 Series:

120/208 V~ or 120/240 V~, 6350 W, 60 Hz (watts for 2114 Series Bucket Pump included)

Unit designed to operate on single phase, 50 AMP, 4 wire supply, 120/208 or 120/240 V~ (2 Hot, 1 Neutral, 1 Ground). All electrical components in this machine are 120 V (motors, heat elements, lights, etc.) and therefore require “Hot to Neutral” connection (**NOT** “Hot to Hot”). A 50 AMP wall receptacle (NEMA 14-50) is supplied with the machine. The receptacle will accept the attachment plug on the machine and must be used; reference the Receptacle Wiring Diagram for NEMA 14-50 for receptacle installation instructions.

	 DANGER
	<p>Machine must be properly grounded to prevent electrical shock to personnel. Failure to do so could result in serious injury, or death. DO NOT immerse any part of this equipment in water. DO NOT use excessive water when cleaning. Keep cord and plug off the ground and away from moisture. Always unplug the equipment before cleaning or servicing. Make sure all machine switches are in the OFF position before plugging the equipment into the receptacle.</p> <p>008_051514</p>

A certified electrician must furnish sufficient power for proper machine operation and install any supplied receptacle. We recommend this equipment be on a dedicated and protected circuit. Failure to wire properly will void the warranty and may result in damage to the machine. It is Gold Medal Products Co.’s recommendation that this machine be plugged directly into a wall outlet. The use of extension cords is not recommended due to safety concerns, and may cause sacrificed and/or reduced performance. Make sure cord is located to prevent a trip hazard or unit upset.

Receptacle Wiring Diagram for NEMA L14-30 (36 oz. Units)

A certified electrician must follow the IMPORTANT instructions below for installation of the NEMA L14-30 Receptacle (Gold Medal Item No. 82208) provided with the unit.

If the receptacle is wired incorrectly, the heat elements/kettle and other electrical components could be at 208 or 240 V potential instead of the needed 120 V, resulting in excessive temperatures in the heat elements (i.e.: kettle) and possible fire, and/or damage to electrical components.

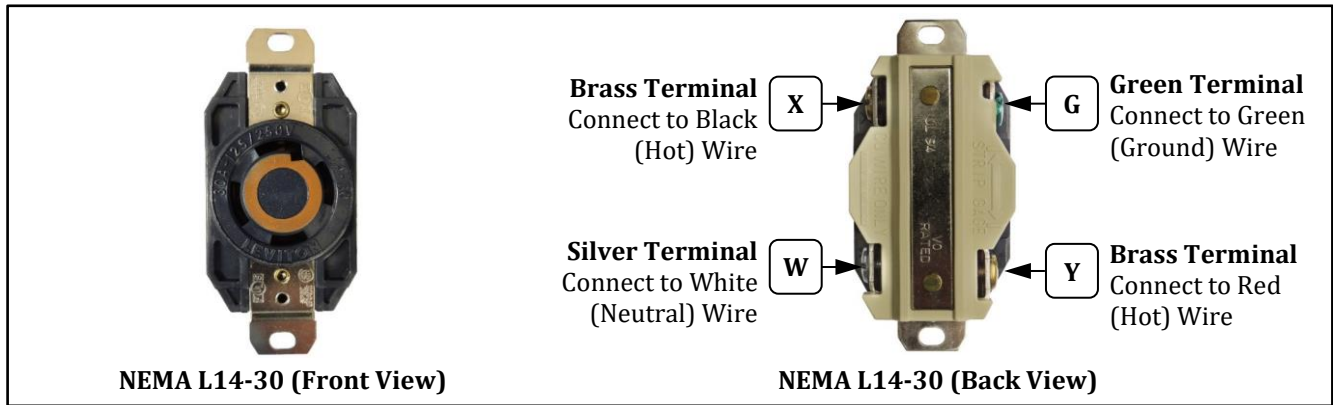

Receptacle Wiring Diagram for NEMA 14-50 (48 and 60 oz. Units)

A certified electrician must follow the IMPORTANT instructions below for installation of the NEMA 14-50 Receptacle (Gold Medal Item No. 82920) provided with the unit.

If the receptacle is wired incorrectly, the heat elements/kettle and other electrical components could be at 208 or 240 V potential instead of the needed 120 V, resulting in excessive temperatures in the heat elements (i.e.: kettle) and possible fire, and/or damage to electrical components.

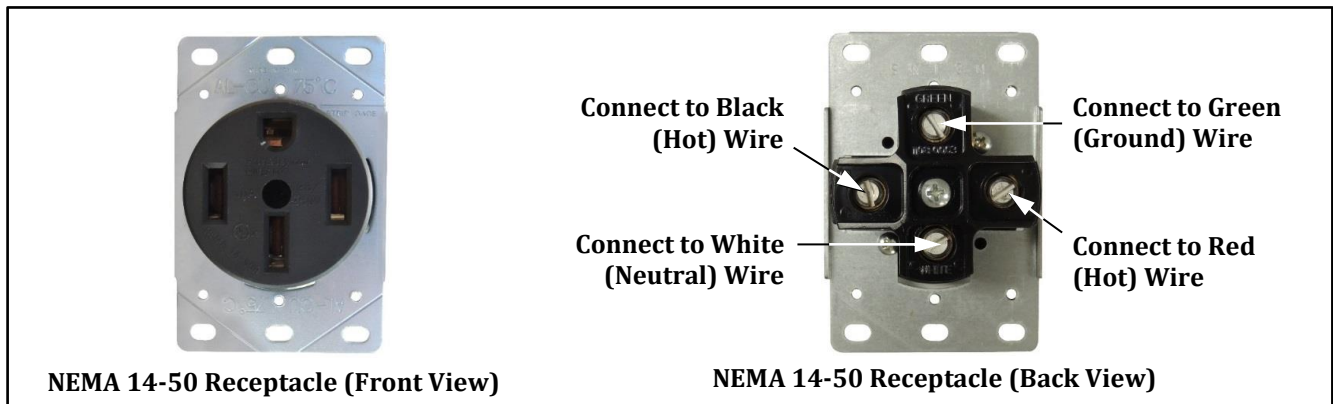

Before You Plug In Machine

1. Make sure all machine switches are OFF before plugging equipment into receptacle.
2. Make sure wall outlet can accept the grounded plugs (where applicable) on the power supply cord.
3. The wall outlet must have the proper polarity. If in doubt, have a competent electrician inspect the outlet and correct if necessary.
4. **DO NOT** use a grounded to un-grounded receptacle adapter (where applicable).
5. Install unit in a level position.

	CAUTION
	If the supply cord is damaged, it must be replaced by Gold Medal Products Co., its service agent or similarly qualified persons in order to avoid a hazard. <small>039_080614</small>



OPERATING INSTRUCTIONS

Controls and Their Functions

This section describes the unit controls (reference image at end of section, for control locations).

KETTLE HEAT SWITCH (Kettle Circuit Breaker)

Two position, ON/OFF lighted rocker switch - supplies power to the heating elements in the popping kettle by sending power to the “Big Eye” Electronic Temperature Control System.

IMPORTANT NOTE: The Kettle Heat Switch is inactive if the Kettle Circuit Breaker is tripped. If unit is plugged in, but green Heat Switch light does not come on when activated, then the Kettle Circuit Breaker may be tripped. Reference the Kettle Does Not Heat section in the Troubleshooting section of this manual.

KETTLE MOTOR SWITCH

Two position, ON/OFF lighted rocker switch - supplies power to the kettle agitator motor. The Kettle Motor Switch **MUST** be ON at all times when there is popcorn (popped or un-popped) in the kettle.

HIGH/LOW KETTLE TEMPERATURE SWITCH

Two position rocker switch – adjusts kettle temperature for Salt (HIGH) or Sweet (LOW) popping mode.

LOAD/DUMP INDICATOR LIGHT & AUDIBLE SIGNAL

During normal popper operation, the yellow Load/Dump light and audible sound (if engaged), are used to signal Load/Dump. If the yellow indicator light is ON, and the buzzer is sounding, **one** of the following actions should be taken:

- Load the corn and oil **or**
- Dump the popped corn from the kettle **or**
- Turn the Kettle Heat Switch OFF if you are finished popping corn.

During calibration of the oil dispense unit, the indicator light (Oil Light or Load/Dump Light) is used to indicate when the oil dispense unit is in program mode.

Auto Shut Off / Error Codes – The Load/Dump light is used to indicate Auto Shut Off (if enabled) and Control Board Error Codes (qualified service personnel reference the Electronic Temperature Control section of the Parts Manual for a full description of the Auto Shut Off feature and for the Control Board Error Code descriptions).



OIL SYSTEM MASTER SWITCH

Two position, ON/OFF lighted rocker switch - supplies power to the oil pump (either the Bag-in-a-Box or Bucket Pump model). Reference the Instruction Manual for the oil dispense unit.

Bag-in-a-Box Model: Oil System Master Switch ON, provides power to the oil dispense unit, activates the warmer/blower, and the heated line kit (if equipped).

Note: Coconut oil will congeal at temperatures below approximately 76°F (24°C). For machines used daily, leave the Oil System Master Switch on at all times and keep the cabinet doors closed to prevent the oil from becoming solid. If the machine has not been used for several days, turn the Oil System Master Switch ON the night before it is expected to be used.

Bucket Pump Model: Oil System Master Switch ON, activates the 30 watt heating element on the bucket pump to keep the coconut oil liquid.

RED OIL DISPENSE PUSH BUTTON (PB) SWITCH & GREEN OIL LIGHT

Red Push Button Switch - dispenses a predetermined amount of oil into the kettle when pressed. The Oil System Master Switch must be ON for the Oil Dispense PB Switch to activate. The Oil Light on the popper will light continuously when oil pump is dispensing. Reference the Instruction Manual for the oil dispense unit.

During calibration of the oil dispense unit, the indicator light (Oil Light or Load/Dump Light) is used to indicate when the oil dispense unit is in program mode.

CIRCUIT BREAKERS

Two mini Circuit Breakers are located on the control panel, to protect the popper unit from overload condition. If unit is plugged in, but the kettle motor or oil system does not come on when activated, then the circuit breaker(s) may be tripped. (Reference the Troubleshooting section of this manual).

TEMPERATURE/CYCLE COUNT (Digital Display and RED Push Button Switch)

The Digital Display shows the popping temperature of the kettle and number of popcorn cycles completed by the unit. Set the Digital Display to show the cycle count. The temperature portion is for troubleshooting purposes for qualified service personnel reference (temperature has degree (°) symbol after the number). To alternate between popping temperature and cycle counts, press the RED Temp/Count Push Button Switch.

To reset the popcorn cycle count, **press and hold** the RED Temp/Count Push Button Switch for 5 seconds, the display count will start to blink to warn the user the count is about to be reset to zero. Continue to hold the push button 3 more seconds and the count will reset to zero.

Note: Display is selectable to show either °F or °C Temperatures (unit is preset at installation, replacement display must be set by qualified service personnel only).

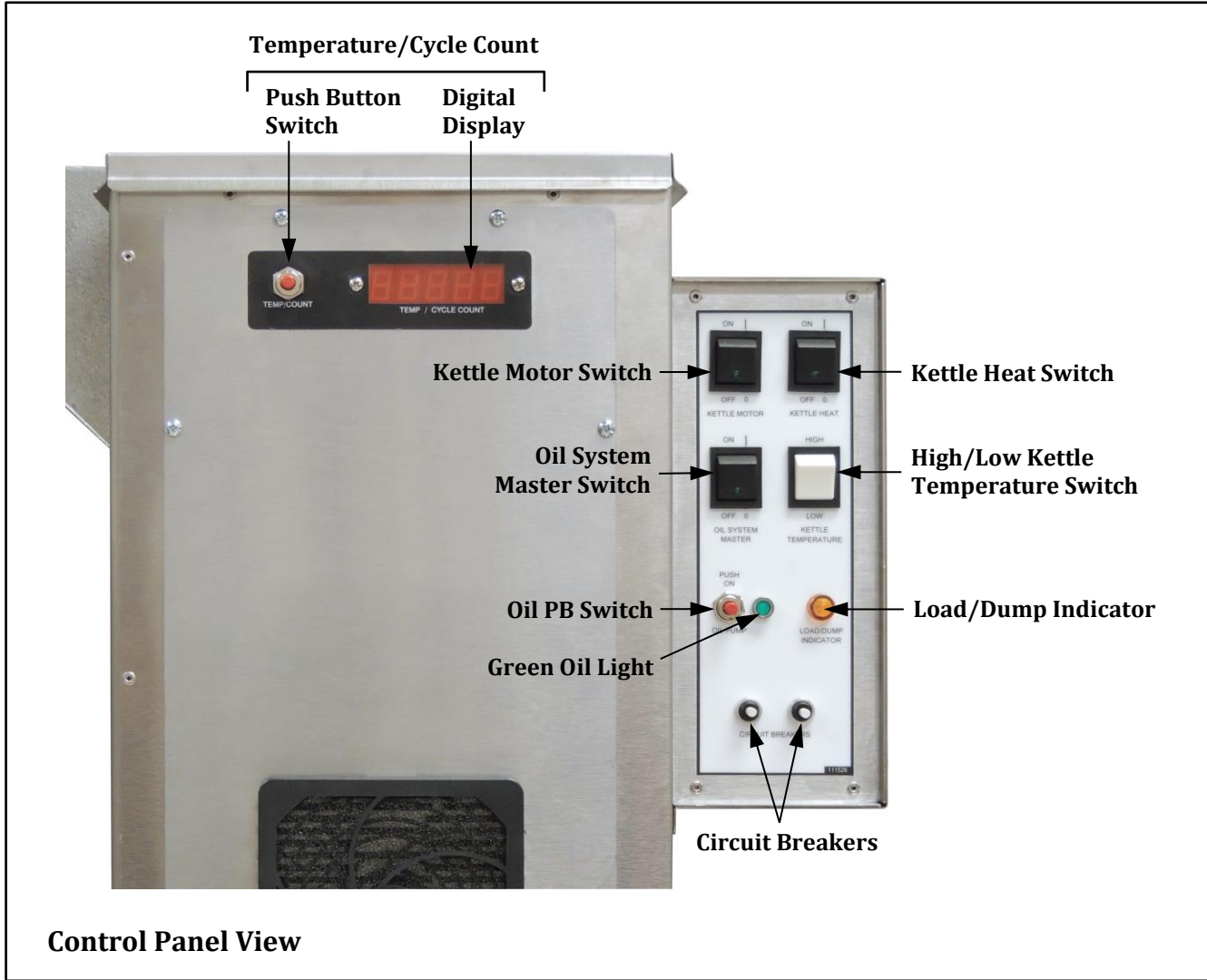



Program the E-Z Set Timer

The oil dispense volume is set using the programmable timer on the electronic control board of the popper, or by using the internal timer of the oil dispense unit (reference the Oil Dispense Unit manual). The number of timer settings available for the popper can be determined as follows:

If using a NO TIMER oil unit: 2 timer settings are available on the control board of the popper.

If using a DUAL TIMER oil unit: 2 internal timer settings are available on the oil dispense unit.

Follow the steps below to program the timer to dispense the oil amount needed to pop a batch of popcorn. It is recommended to set the oil volume to approx. 30% of the raw popcorn charge used.

To program, use the Oil Dispense Switch and the Oil System Master Switch located on the control panel of the popper.

Note: Take volume measurements from oil delivery tube located in popper above the kettle. Allow kettle to cool completely prior to taking volume measurements.

Priming the Unit:

1. Turn Oil System Master Switch ON.
2. Hold a cup under the oil delivery tube in popper, **PUSH and RELEASE** the Oil Dispense Switch to START dispensing oil.
3. As soon as oil flows steady, turn Oil System Master Switch OFF; unit is now primed. Wait 30 seconds to allow oil to settle/drain before programming.

Programming the Unit:

4. Hold down Oil Dispense Switch and turn Oil System Master Switch ON, **continue to hold Oil Switch for 5 seconds** until the indicator light (OIL Light or LOAD/DUMP Light) on popper starts to blink ON-OFF, then release switch; unit now in program mode.
5. Hold a measuring cup under the oil delivery tube in popper; **PUSH and RELEASE** the Oil Dispense Switch to START oil flow.
6. When correct amount of oil has been dispensed, **PUSH and RELEASE** Oil Dispense Switch again to STOP oil flow. The Oil Switch may be pushed ON/OFF as many times as needed to finalize ("top off") the oil amount.
7. Turn Oil System Master Switch OFF, then back ON to **SAVE the setting**. Unit will now dispense the "programmed" amount of oil when the Oil Dispense Switch is pushed. The Oil Light on the popper will light continuously when oil pump is dispensing.
8. Wait 30 seconds to allow oil to settle/drain, then re-check the oil quantity.

Dual Timer Note: Units with two oil timer settings available must be set for Flexi-Pop, if available on the unit (Flexi-Pop option not available on Cornado units). Otherwise, the two settings must be used for Salt/Sweet (High/Low) option. Select one corn amount and program the first timer; then select the other corn amount and program the second timer. (Pumps with a single timer will only remember the last setting programmed.)

Manual Mode (Oil only dispenses when the Oil Dispense Switch is held IN):

OPTIONAL - Use to manually dispense oil, or for cleaning. Follow Step 4 then skip to Step 6.

To use a timer setting after using Manual Mode, the unit MUST be reprogrammed.



Popping Corn Instructions

This section describes popping instructions for Salted Popcorn and Sweet Popcorn (if equipped with Salt-Sweet or High-Low temperature option).

Remember (for all popping modes): When the Load/Dump Light comes ON, and Audible Signal (if enabled) is sounding, **one** of the following actions should be taken:

- Load the corn and oil **or**
- Dump the popped corn from the kettle **or**
- Turn OFF the Kettle Heat if you are finished popping corn.

The popper is equipped with a corn, salt, and oil measure. We recommend flavored and colored coconut oil. Popcorn popped in coconut oil stays fresh longer and does not leave black deposits in the kettle like other oils. Use only top quality, fresh popcorn from reputable suppliers.

Popping Salted (Standard) Popcorn

Raw Popcorn Charge:	Use corn measure provided (ex: for 36 oz. Kettle, use 36 oz. corn)
Recommended Oil Volume:	Oil volume is approx. 30% of corn amount (ex: for 36 oz. corn, use 10.8 oz. oil)
Flavacol (Salt) Amount:	Use small Flavacol scoop provided

Note: When using coconut oil, be sure the oil is liquid. As a check, dispense oil into a measuring cup first, then use that oil for the first popping cycle.

1. Turn all switches ON; set popping temperature option (if equipped) to Salt (High) mode.
2. Kettle is ready to pop (about 5-8 minutes), when the yellow Load/Dump Light and Audible Signal (beeper, if enabled) turn ON.
3. Lift kettle lid and pour in pre-measured popcorn and Flavacol; close lid.
4. Press the “Red” Oil Dispense PB Switch to add oil (if equipped), or add oil manually before closing lid (light and beeper will turn OFF in approx. 20 seconds).
5. When the light and beeper come on again, gently dump the kettle.

Note: The signal “To Dump” was factory set based on Gold Medal popcorn and oil. If, after 3 consecutive batches, the signal occurs before or after popping has stopped, then the signal timing can be adjusted by a qualified service person (reference Electronic Temperature Control section).

Popping Tip: On final batch, turn Kettle Heat Switch OFF just as lids are forced open by the popping corn (kettle has plenty of heat to finish popping). This helps eliminate smoke/odor from any oil residue remaining in kettle. With the Heat Switch OFF, **the light and beeper will not activate for the last batch.**

6. When finished popping, turn KETTLE HEAT and KETTLE MOTOR switches OFF.
NEVER LEAVE THE HEAT ON WHEN YOU ARE NOT POPPING CORN!

Units with an auto kettle heat shut off feature will automatically shut kettle heat OFF after 15 min. of idle time (no popcorn popped). To restart heating, cycle the Heat Switch OFF-ON.



Popping Sweet Popcorn

Gold Medal recommends white coconut oil for popping Glaze Pop (colored oil can change the popcorn color). Glaze Pop cooks directly in the kettle. **DO NOT** use popcorn seasoning salt when popping Glaze Pop.

Raw Popcorn Charge:	Use corn measure provided (ex: for 36 oz. Kettle, use 36 oz. corn)
Recommended Oil Volume:	Oil volume is approx. 30% of corn amount (ex: for 36 oz. corn, use 10.8 oz. oil)
Glaze Pop/Sugar Amount:	Use amount equal to 1/2 the quantity of corn (ex: for 36 oz. corn, use 18 oz. Glaze Pop)

Note: When using coconut oil, be sure the oil is liquid. As a check, dispense oil into a measuring cup first, then use that oil for the first popping cycle.

1. Turn all switches ON; set popping temperature option (if equipped) to Sweet (Low) mode.
2. Kettle is ready to pop (about 5-8 minutes), when the yellow Load/Dump Light and Audible Signal (beeper, if enabled) turn ON.
3. Lift kettle lid and pour in pre-measured popcorn and Flavacol; close lid.
4. Press the “Red” Oil Dispense PB Switch to add oil (if equipped), or add oil manually before closing lid (light and beeper will turn OFF in approx. 20 seconds).
5. Add pre-measured amount of Glaze Pop or Sugar (when using sugar, we recommend using Compound “S” to help keep kettle clean); close lid.
6. When the light and beeper come on again, gently dump the kettle.

Note: The signal “To Dump” was factory set based on Gold Medal popcorn and oil. If, after 3 consecutive batches, the signal occurs before or after popping has stopped, then the signal timing can be adjusted by a qualified service person (reference Electronic Temperature Control section).

Popping Tip: On final batch, turn Kettle Heat Switch OFF just as lids are forced open by the popping corn (kettle has plenty of heat to finish popping). This helps eliminate smoke/odor from any oil residue remaining in kettle. With the Heat Switch OFF, **the light and beeper will not activate for the last batch.**

7. When finished popping, turn KETTLE HEAT and KETTLE MOTOR switches OFF. **NEVER LEAVE THE HEAT ON WHEN YOU ARE NOT POPPING CORN!**

Units with an auto kettle heat shut off feature will automatically shut kettle heat OFF after 15 min. of idle time (no popcorn popped). To restart heating, cycle the Heat Switch OFF-ON.

8. Clean kettle when finished popping Glaze Pop or sugar corn, and prior to switching to salted popcorn.



Care and Cleaning

	⚠ DANGER
	<p>Machine must be properly grounded to prevent electrical shock to personnel. DO NOT immerse in water. DO NOT clean appliance with a water jet. Always unplug the equipment before cleaning or servicing.</p> <p style="text-align: right;">025_111616</p>

	⚠ WARNING
	<p>To avoid serious burns, DO NOT touch the kettle while it is hot!</p> <p style="text-align: right;">028_082715</p>

Good sanitation practice demands that all food preparation equipment be cleaned regularly (only use non-toxic, food grade cleaners). A clean looking, well-kept machine is one of the best ways of advertising your product.

Note: It is extremely important to follow all cleaning procedures, otherwise parts damage and equipment failure will result. The warranty does not cover parts that are damaged due to improper cleaning.

Daily Kettle Cleaning Instructions

CAUTION: A hot kettle will cause burns if you touch it with your hand. Allow kettle to cool at least 1 hour before attempting to clean. **DO NOT** use ice or water to cool down a hot kettle! Severe kettle damage will result!

1. When cool, wipe **outside** of kettle with a clean, soft cloth. **DO NOT** use oven cleaners or abrasive materials as they will damage the kettle.
2. Every night, mix Gold Medal's Heat'n Kleen solution (Item No. 2095), 2 tablespoons per gallon of water. It is not necessary to use the entire gallon at once; only use enough to fill the kettle 1/2 inch deep.
3. Turn kettle heat ON. When water starts to boil, turn kettle heat OFF.
4. Allow to cool at least 1 hour, then dump solution into a bucket and wipe inside of kettle with a clean cloth. Make sure all solution goes into the bucket; do not spill any in the interior of machine.

For an extra dirty kettle, the process may be repeated; or, after turning kettle heat OFF, allow solution to sit in kettle overnight. The next morning, dump solution into a bucket and wipe inside of kettle with a clean cloth.

5. With unit OFF and unplugged, wipe kettle lead cord with a clean SLIGHTLY damp cloth. **DO NOT get moisture into the kettle lead-in cord, severe damage will result.**

To Remove/Install Kettle Lid (if needed)

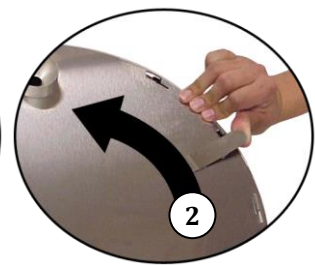
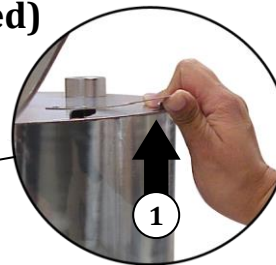

To Remove Kettle Lid:

Lift TAB slightly, rotate lid assembly to disengage raised hooks; then lift lid off.
(Reverse steps to install lid.)

Daily Unit Cleaning Instructions

1. Turn machine OFF, unplug unit and allow it to cool before attempting to clean.
2. Clean all pans/accessories in order to sanitize them before each use.
3. Take a clean, SLIGHTLY damp cloth and wipe excess grease from unit.
4. Wipe stainless steel parts with a clean cloth and cleaner designed for stainless steel, such as Gold Medal Watchdog Stainless Cleaner (Item No. 2088).

DO NOT use oven cleaners or abrasive materials as they will damage parts of machine.

Sanitizing the Tubing and Pump

Reference the Oil Dispense Unit manual for oil system cleaning instructions.



Weekly Agitator and Hub Seal Assembly Cleaning Instructions

Important: For proper machine performance, keep agitator and hub assembly clean.

Follow the steps below weekly to ensure proper machine performance.

Steps to Clean Agitator and Hub Assembly

Step 1: Turn unit OFF, and allow it to cool completely before attempting to remove agitator shaft.

On the bottom side of the kettle, hold the Agitator Shaft firmly with Channel Lock pliers.

NOTE: The shaft has a left handed thread.

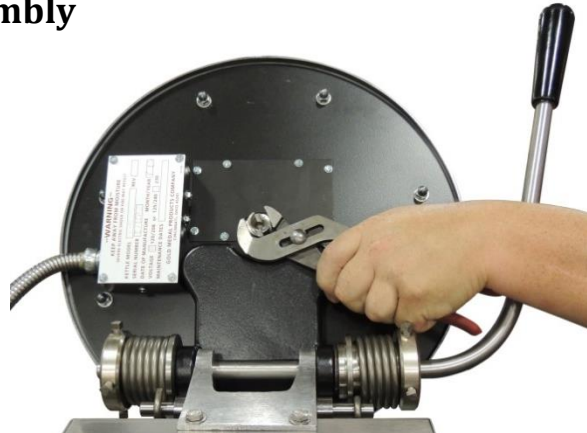

Step 2: To loosen the Agitator Assembly, tap the agitator's welded bar with a rubber mallet in a CLOCKWISE direction, and unscrew to remove.

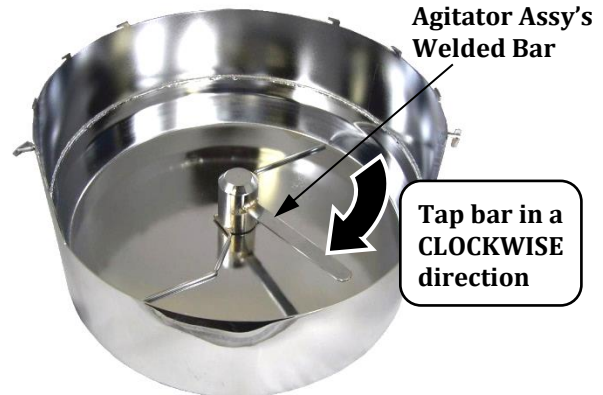

Step 3: Leave the Packing Cage and Packing Cord intact. ONLY wipe hub assembly surfaces to remove product residue, and clean the inside of the agitator hub to remove any nicks and carbon build-up.

If packing cage is removed, then the packing cord should be replaced (see Replacing the Packing Cord on Kettle Hub in the Maintenance section of this manual.)

Kettle Bushing
Packing Cage
Packing Cord
Kettle Hub

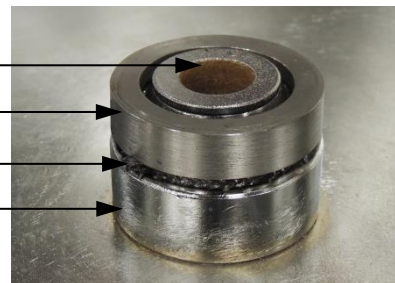

Step 4: Reinstall agitator assembly.



Troubleshooting



Issue	Possible Cause	Solution
Power to the Unit	<p>A. Power to the Unit</p> <p>B. Mini Circuit Breaker(s) on popper tripped</p>	<p>A. Make sure the unit's lead-in cord is plugged in.</p> <p>B. Mini Circuit Breaker(s) supplies power to all unit features. The Mini Circuit Breaker(s), will be located on the control panel of the popper. If breaker(s) is reset, then trips again, the unit must be inspected/repared before going any further.</p>
Kettle Does Not Heat	<p>A. Kettle Circuit Breaker</p> <p>B. Kettle Heat Switch</p> <p>C. Temperature Control Board</p>	<p>A. If unit is plugged in, and the Kettle Heat Switch is ON, but the small green indicator switch light is off, then the Kettle Circuit Breaker may be tripped.</p> <p>Have a qualified service person check if the breaker has tripped (breaker is located behind the front cover plate). The Kettle Circuit Breaker may trip during transit; if reset then trips again, the unit must be inspected/ repaired before going any further (reference the Kettle Circuit Breaker in the Maintenance section).</p> <p>B. Have a qualified service person check the voltage to and from the Kettle Heat switch; and if the switch is defective replace it.</p> <p>C. A defective thermocouple lead will cause the kettle not to heat. Check for control error conditions and have a qualified service person check for good connections from the kettle to the control. (Reference the Error Conditions of the Electronic Temperature Control in the Maintenance section.)</p>
Oil Pump Does Not Deliver Oil to Kettle	<p>A. Mini Circuit Breaker(s) on popper tripped</p> <p>B. Oil Dispense Unit</p>	<p>A. Check the Mini Circuit Breaker(s); if reset, then trips again, the unit must be inspected/ repaired by qualified service personnel.</p> <p>C. Check for air leaks into the oil line; be sure the filter in the line is not loose.</p> <p>For additional possible causes/solutions, reference the Troubleshooting section of the Oil Dispense Unit Manual.</p>







Issue	Possible Cause	Solution
<p>Long Popping Cycles (Longer than 4 minutes for Salt Popcorn)</p>	<p>A. Heating Element</p> <p>B. Low Voltage</p> <p>C. Inadequate Supply Lines</p> <p>D. Inferior Corn</p>	<p>A. One of the heating elements in the kettle may be burned out. This would result in the kettle never reaching the proper operating temperature. Check with a qualified service person for inspection/repair.</p> <p>B. If the machine is operated on low voltage, this could cause the kettle not to reach the proper operating temperature. Check with a qualified electrician.</p> <p>C. Inadequately sized electrical supply lines, in addition to being a fire hazard, would also prevent the kettle from reaching the proper operating temperature. Check with a qualified electrician.</p> <p>D. Inferior quality corn would result in longer popping cycles. Use only top quality hybrid popcorn from reputable suppliers. Even then, if you let your corn pick up moisture or dry out, your popping cycles will be slow.</p>
<p>Kettle Agitator Shaft not Rotating</p>	<p>A. Kettle Motor Switch</p> <p>B. Mini Circuit Breaker on popper tripped</p>	<p>A. If the kettle agitator shaft is not rotating, DO NOT pop corn. Check to make sure the Kettle Motor Switch is ON. If the switch is ON, and the shaft is not rotating, the switch or motor may be faulty, contact qualified service personnel for inspection/repair.</p> <p>B. Check the Mini Circuit Breaker(s); if reset, then trips again, the unit must be inspected/ repaired by qualified service personnel.</p>
<p>Kettle Shaft “binds” when dumped.</p>	<p>A. Shaft Misalignment</p>	<p>A. The upper and lower shafts must align with one another, and the two shafts must not “bind” when the kettle is dumped. Have qualified service personnel adjust alignment (reference the Kettle Drive Shaft Alignment section of this manual).</p>





MAINTENANCE INSTRUCTIONS

	 DANGER
	<p>Machine must be properly grounded to prevent electrical shock to personnel. Failure to do so could result in serious injury, or death. DO NOT immerse any part of this equipment in water. DO NOT use excessive water when cleaning. Keep cord and plug off the ground and away from moisture. Always unplug the equipment before cleaning or servicing. Make sure all machine switches are in the OFF position before plugging the equipment into the receptacle.</p> <p>008_051514</p>

	 DANGER
	<p>Improper installation, adjustment, alteration, service, or maintenance can cause property damage, injury, or death. Any alterations to this equipment will void the warranty and may cause a dangerous condition. This appliance is not intended to be operated by means of an external timer or separate remote-control system. NEVER make alterations to this equipment. Read the Installation, Operating, and Maintenance Instructions thoroughly before installing, servicing, or operating this equipment.</p> <p>014_020416</p>

	 WARNING
	<p>No user serviceable parts inside. Refer servicing to qualified service personnel.</p> <p>011_051514</p>

	 CAUTION
	<p>THE FOLLOWING SECTIONS OF THIS MANUAL ARE INTENDED ONLY FOR QUALIFIED SERVICE PERSONNEL WHO ARE FAMILIAR WITH ELECTRICAL EQUIPMENT. THESE ARE NOT INTENDED FOR THE OPERATOR.</p> <p>027_010914</p>



Removing Agitator Assembly and Shaft Maintenance

The kettle's agitator shaft should be removed every 3 months and lubricated with Never Seez® (Item No. 68751). See below for steps to remove and lubricate the agitator shaft.

Steps to Remove the Agitator Assembly and Lubricate Shaft

Step 1: Turn unit OFF, and allow it to cool completely before attempting to remove agitator shaft.

On the bottom side of the kettle, hold the Agitator Shaft firmly with Channel Lock pliers.

NOTE: The shaft has a left handed thread.

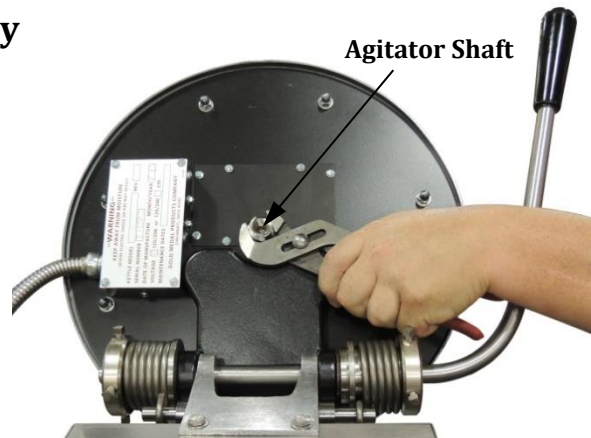

Step 2: To loosen the Agitator Assembly, tap the agitator's welded bar with a rubber mallet in a CLOCKWISE direction, and unscrew to remove.

Leave the Packing Cage/ Packing Cord on the kettle hub intact. If packing cage is removed, then the packing cord should be replaced (see next page, Replacing the Packing Cord on Kettle Hub.)

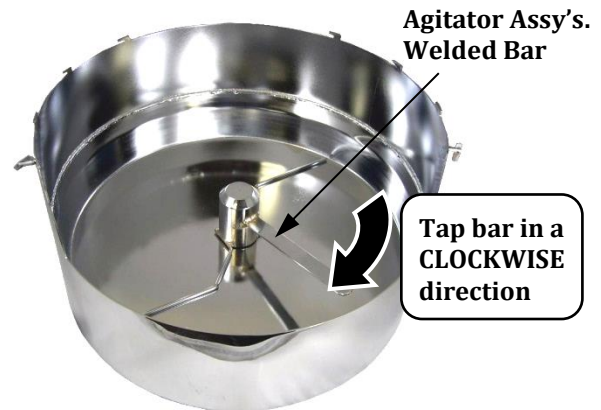

Step 3: Remove the agitator shaft and lubricate with Never Seez® (Item No. 68751). Apply a small amount on the slope and side of pin on the matching shaft.

Step 4: Reinstall agitator assembly for use.

Apply Never Seez®
to Agitator Shaft

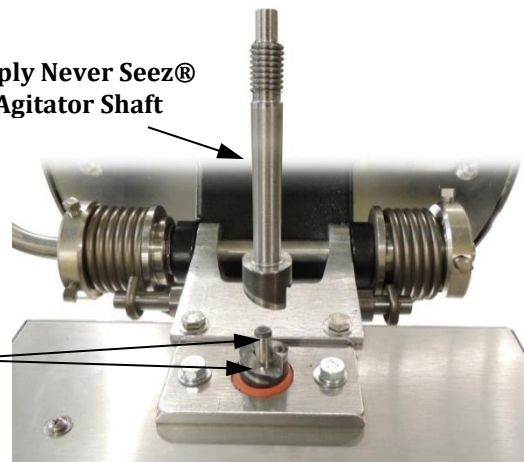

Apply a small amount of Never Seez®
on slope and pin of the matching shaft.



Replacing the Packing Cord on Kettle Hub

The kettle hub assembly (Packing Cage and Packing Cord) is designed for long use if not disturbed. When the unit is properly maintained, the packing cord should not need to be changed. If it is removed, or if the kettle bushings are replaced, then the packing cord should be replaced. Follow the steps below to replace the packing cord.

Steps to Replace Packing Cord

Step 1: Remove agitator assembly (see Removing Agitator Assembly section), then remove the packing cage and the old packing cord.

For older models which have an oil seal, remove the oil seal from inside the agitator hub and replace with the Cornado Packing Kit (Item No. 69305) as described here.

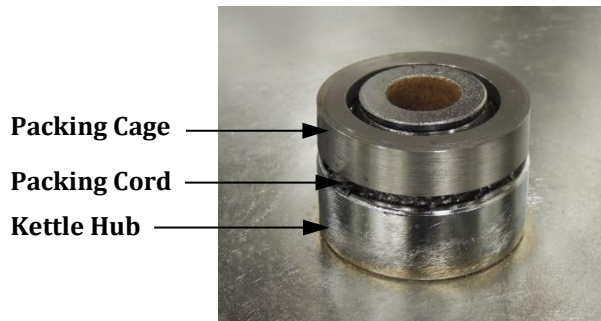

Step 2: Clean the surfaces of the kettle hub with a Scotch Brite pad or fine sandpaper.

Kettle Hub
(Packing Cord will ride on this surface)



Step 3: Wind the new packing cord on the hub. Start at the bottom, and wind up in a CLOCKWISE direction.



Step 4: Push packing cage down onto the packing cord and rotate CLOCKWISE.

Step 5: Before reinstalling agitator assembly, clean the inside of the agitator hub to remove all nicks and carbon build-up.



Kettle and Drive Shaft Alignment

Steps to Adjust the Kettle Drive Shaft

Step 1: To adjust the lower agitator shaft, loosen the two hex bolts for the adjusting plate. It may be necessary to use a socket/wrench on the hex nuts (located inside the pedestal).

Lower Agitator Shaft

Adjusting Plate

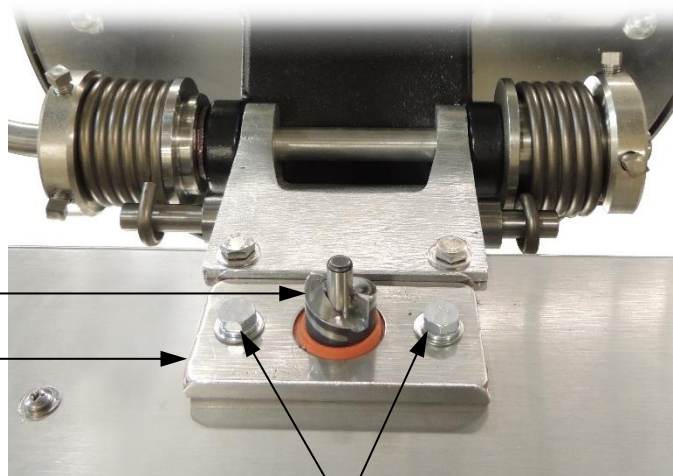

Loosen (2) Hex Bolts

Step 2: Adjust the plate back and forth, and side-to-side, until the lower shaft lines up with the upper shaft in the kettle.

It is important to have the two shafts align with one another, and that the two shafts do not “bind” when the kettle is dumped.

Step 3: Once properly aligned, re-tighten the two hex bolts on the adjusting plate.

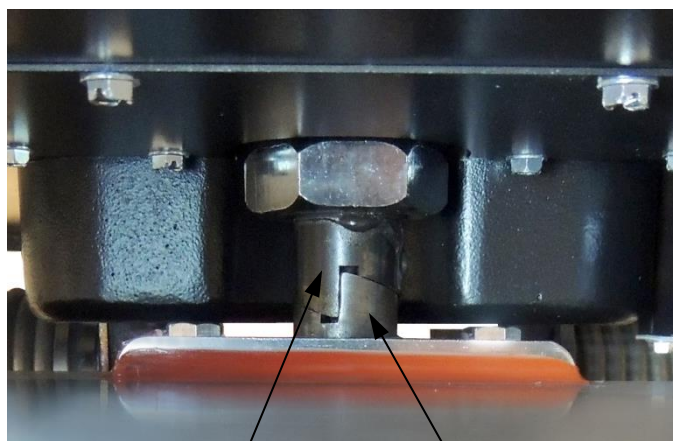

Upper Agitator Shaft
(attached to kettle)

Lower Agitator Shaft
(attached to motor)

Electronic Temperature Control

Operation

The temperature control is factory set to stop the power to the kettle when the thermocouple reaches set point. This is also the ideal point to dump the popped corn out of the kettle. On the first start-up, this is the ideal time to load the corn and oil. Therefore, if the Kettle Heat Switch is turned ON and the buzzer is sounding, **one** of the following actions should be taken:

- Load the corn and oil **or**
- Dump the popped corn from the kettle **or**
- Turn OFF the Kettle Heat Switch if you are finished popping corn.

Control Description

This unit has an electronic kettle heat control with 2 thermocouples (TC), one for set point control and one for fixed high limit. There are no mechanical thermostats in this kettle.

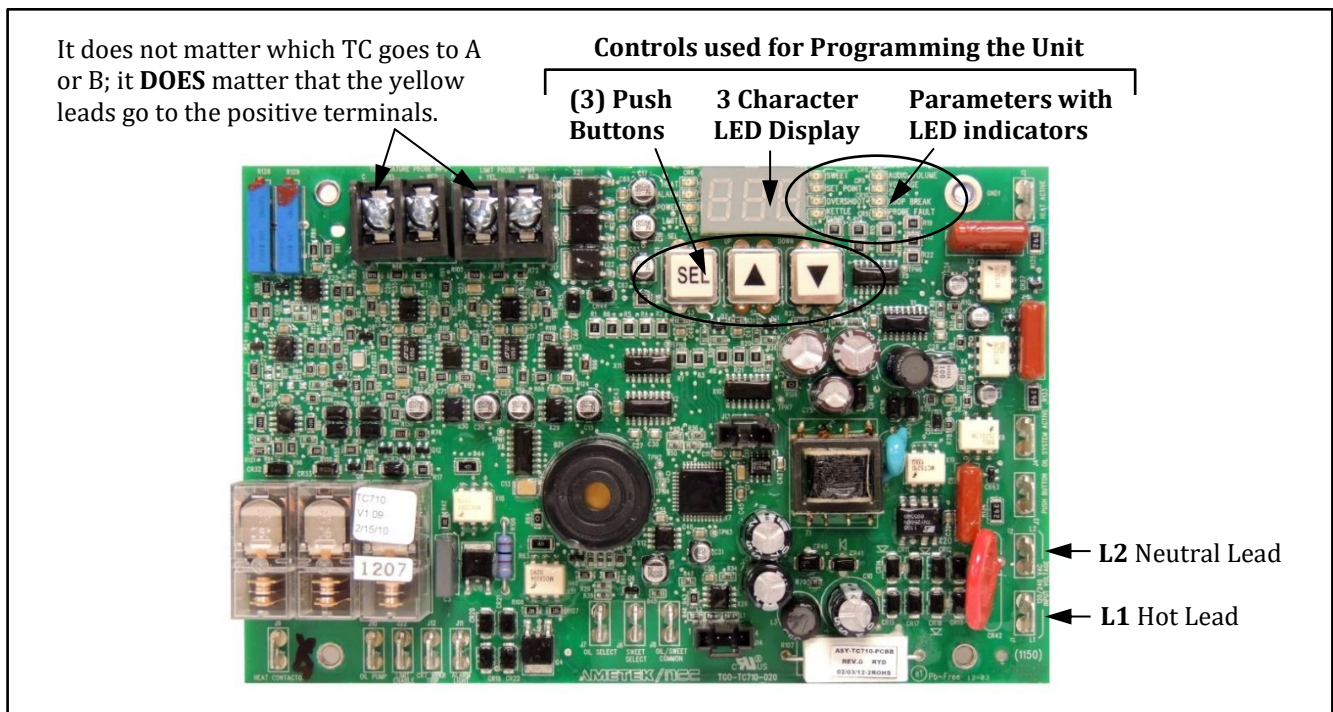

There are (7) factory parameters on the control (see descriptions below). If needed, adjustments may be made to Kettle Dump, Audio Volume, and Auto Shut Off (see Programming the Electronic Control on next page). **The remaining settings are factory set for the unit, DO NOT adjust.**

1. **Set Point Temperature** – This is factory set, **DO NOT adjust.**
2. **Overshoot** – This circuit is tuned for the kettle at the factory, **DO NOT adjust.**
3. **Kettle Dump** – The Kettle Dump Offset is factory set at 37°F (valid range is 0 to 50). This notes the dump point temperature is 37°F less than the set point temperature. For the signal to dump to sound sooner, increase the degree value; to sound later, decrease the degree value.



4. **Audio Volume** - The audible signal to dump is preset at the factory to level 8, valid range is 0 (off) to 10 (full volume).
5. **Voltage Slope** – This is factory set to zero (0), **DO NOT adjust**.
6. **Loop Break** – This is factory set to zero (0), **DO NOT adjust**.
7. **Auto Shut Off** – The default factory setting is OFF. To change this setting, scroll through the parameters until Loop Break is active, then press the “DOWN” arrow again to view the Auto Shut Off parameter (the 3 Character LED Display will read “Aof” if the Auto shut Off is disabled, and it will display “Aon” if it is enabled).

When this feature is enabled, the Auto Shut Off will automatically turn the kettle heat off after 15 minutes of idle time (no popcorn popped). This feature saves electrical power and extends the life of the kettle heating element and thermocouples, since it will not cycle off-on when the kettle heat switch is left on.

1. When the kettle heat switch is turned ON, and the thermocouple reaches set point, the Auto Shut Off 15 minute timer starts; the 15 minute timer resets each time a batch of popcorn is popped.
2. The Dump Light on the control panel will blink OFF-ON once per second (if Audio Volume is on the unit will also beep) to indicate the kettle has been automatically turned OFF.
3. To restart the kettle heating, cycle the kettle heat switch OFF-ON.

Programming the Electronic Control

The settings for the Kettle Dump, Audio Volume, and Auto Shut Off parameters may be adjusted if needed. Follow the steps on next page to select the parameter to be adjusted, to put it into programming mode, and adjust the setting.

Note: Units with Salt/Sweet capability must be in the appropriate mode to adjust settings for that mode. When in the Sweet mode, the Sweet parameter light (see image below) will be ON steady. If the Sweet light is NOT on, the unit is in the Salt mode.

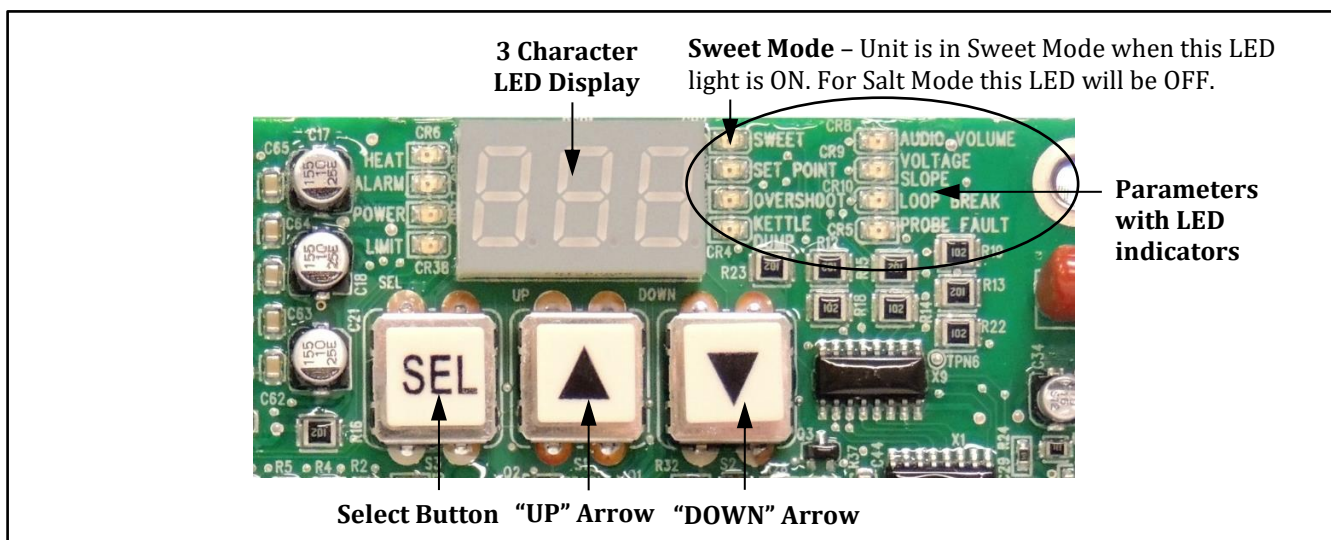



Steps to Program a Parameter:

1. Use the “UP” and “DOWN” arrow buttons to select the parameter to be programmed. The LED light next to the selected parameter will turn ON to indicate it is active, and the 3 Character LED Display will show the current setting for that parameter.
2. **Press and hold** the “SEL” (select button) for 3 seconds to enter the programming mode. The active LED starts to blink ON/OFF indicating it is in the programming mode.
Note: If no button is pushed within 10 seconds, the control will automatically exit the program mode and the old values will remain unchanged.
3. Adjust the value displayed using the “UP” or “DOWN” arrow buttons.
4. Once the desired value is reached, press “SEL” to save the setting and exit the programming mode. The active LED will stop flashing.
5. Repeat the steps above to change additional settings, if needed.

Error Conditions for the Electronic Control

There are six error conditions which can be detected by the control. If an error condition is detected, the control will disable the heat output, and the Dump Light will flash the number of times to indicate the error code (if Audio Volume is on, the control will also beep to indicate the error code). The LED Display will indicate the error code by alternating the message “err” and the error code (1-6). This sequence will repeat until the error condition is corrected, and the Heat Switch is cycled OFF then back ON.

For example: If an Open Probe (code 2) is detected, the Dump Light will flash 2 times (and if enabled, the sound will beep 2 times) then pause with no light (or sound) for period of 3 seconds. The LED Display will show the code 2 error by alternating the message “err” and 2.

The following list describes each error code condition:

- **Reversed Probe (code 1)** – Error code 1 indicates the thermocouple probe has been connected in reverse. (The yellow leads must be to the positive terminals.)
- **Open Probe (code 2)** – Error code 2 indicates the thermocouple probe is disconnected.
- **Loop Break (code 3)** – The Loop Break is factory set to zero, and should NOT be adjusted, so this code is not applicable to this unit.
- **Kettle heating when no heating commanded (code 4)** – If the control and limit relays stick on, the kettle will heat even with the heat switch off. For this condition the control will show error code 4.
- **Wrong voltage to heat elements (code 5)** – The voltage slope parameter is factory set to zero, and should NOT be adjusted, so this code is not applicable to this unit.
- **Maximum kettle temperature exceeded (640°F) (code 6)** – Error code 6 indicates the kettle heat has exceeded the maximum temperature of 640°F. This error condition will exist until the sensed temperature is less than 550°F, which is below the high limit set point.



Kettle Circuit Breaker

This machine is equipped with a Kettle Circuit Breaker. The circuit breaker may trip during shipment of the unit due to vibrations encountered in transit. If the breaker is tripped the kettle will not heat. The circuit breaker must be reset by qualified service personnel only.

IMPORTANT NOTE: Various issues may prevent the kettle from heating. Prior to checking the Kettle Circuit Breaker, reference the Troubleshooting section of the Instruction Manual to check for other possible issues.

Checking the Kettle Circuit Breaker

To check if the Kettle Circuit Breaker has tripped, turn the Kettle Heat Switch ON. The small green indicator light on the Kettle Heat Switch should turn ON. If the green indicator light is OFF, when the Kettle Heat Switch is in the ON position, **the circuit breaker is tripped**.

- **For hanging kettle machines** – On Standard Poppers, the Kettle Circuit Breaker is located under the dome. An additional cover must be removed to reset the circuit breaker. On PopClean Poppers, the side dome panel must be removed to access the circuit breaker located on the vertical controls panel in the dome interior (reference images below).
- **For pedestal mounted kettle machines** - the front cover plate must be removed to access the Kettle Circuit Breaker (reference image below).

The circuit breaker should only be reset after a qualified service person has checked the complete kettle circuit for faults. The limit and heating contactors/relays should be checked to ensure that the contacts are not welded together. The kettle receptacle and plug (if equipped) should be checked for loose contacts or shorted wiring. The popcorn kettle bottom must be examined to ensure there is no loose hardware or other items causing a short circuit. All wiring in the kettle circuit should be checked for fraying wires, short circuits, and loose connections.

<p>Standard Poppers Kettle Circuit Breaker is located under dome, then remove breaker cover to access CB.</p>	<p>PopClean Poppers Kettle Circuit Breaker is located on Vertical Controls Panel in dome interior; then remove breaker cover to access CB.</p>	<p>Kettle Circuit Breaker is located behind front cover plate; then remove breaker cover to access the CB.</p>
<p>Hanging Kettle Poppers</p>		<p>Cornado Poppers (Pedestal Style)</p>



ORDERING SPARE PARTS

1. Identify the needed part by checking it against the photos, illustrations, and/or parts list. (General images may be used in manual for reference only.)
2. Use only approved replacement parts when servicing this unit.
3. When ordering, please include part number, part name, and quantity needed.
4. Please include your model number, serial number, and date of manufacture (located on the machine nameplate/data plate) with your order.
5. Address all parts orders to:

Parts Department
Gold Medal Products Co.
10700 Medallion Drive
Cincinnati, Ohio 45241-4807

Or, place orders by phone or online:

Phone: (800) 543-0862
(513) 769-7676
Fax: (800) 542-1496
(513) 769-8500
E-mail: info@gmpopcorn.com
Web Page: gmpopcorn.com

Unit Exterior – Front View – Filter

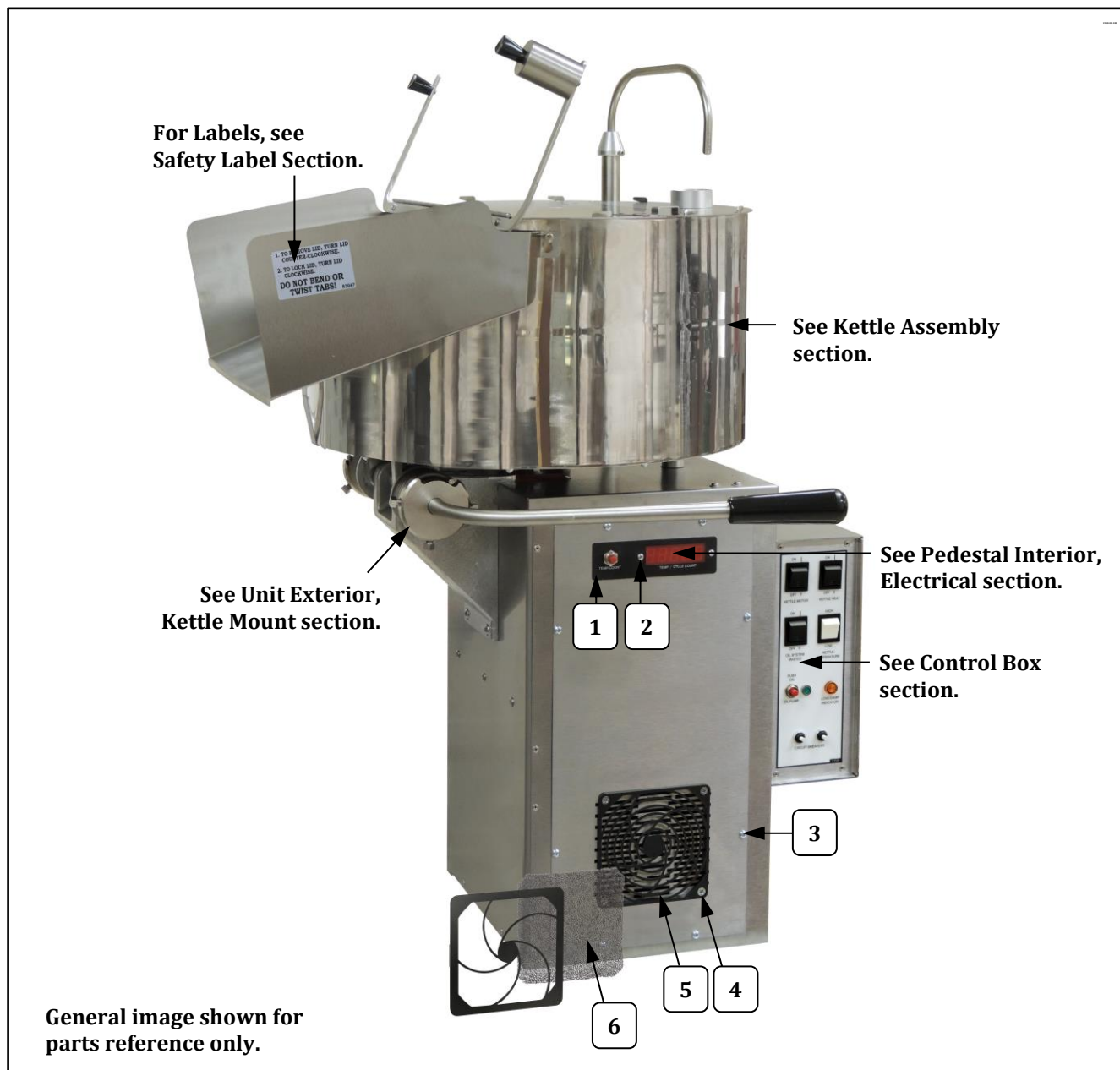

Item	Part Description	Part Number
		All Models
1	TEMP/CYCLE COUNT LABEL	111529
2	6-32 X 3/8 PHIL PAN M/S	39000
3	GLIDE SCREW #8-32X3/8 PAN HD PH	74141
4	8-32 X 3/4 PHIL FLAT M/S	47125
5	FILTER AND GUARD ASSY (includes Guard, Filter, and Cover)	63707
6	FILTERS(BAG OF 5)	69917

Unit Exterior – Rear View - Oil Line

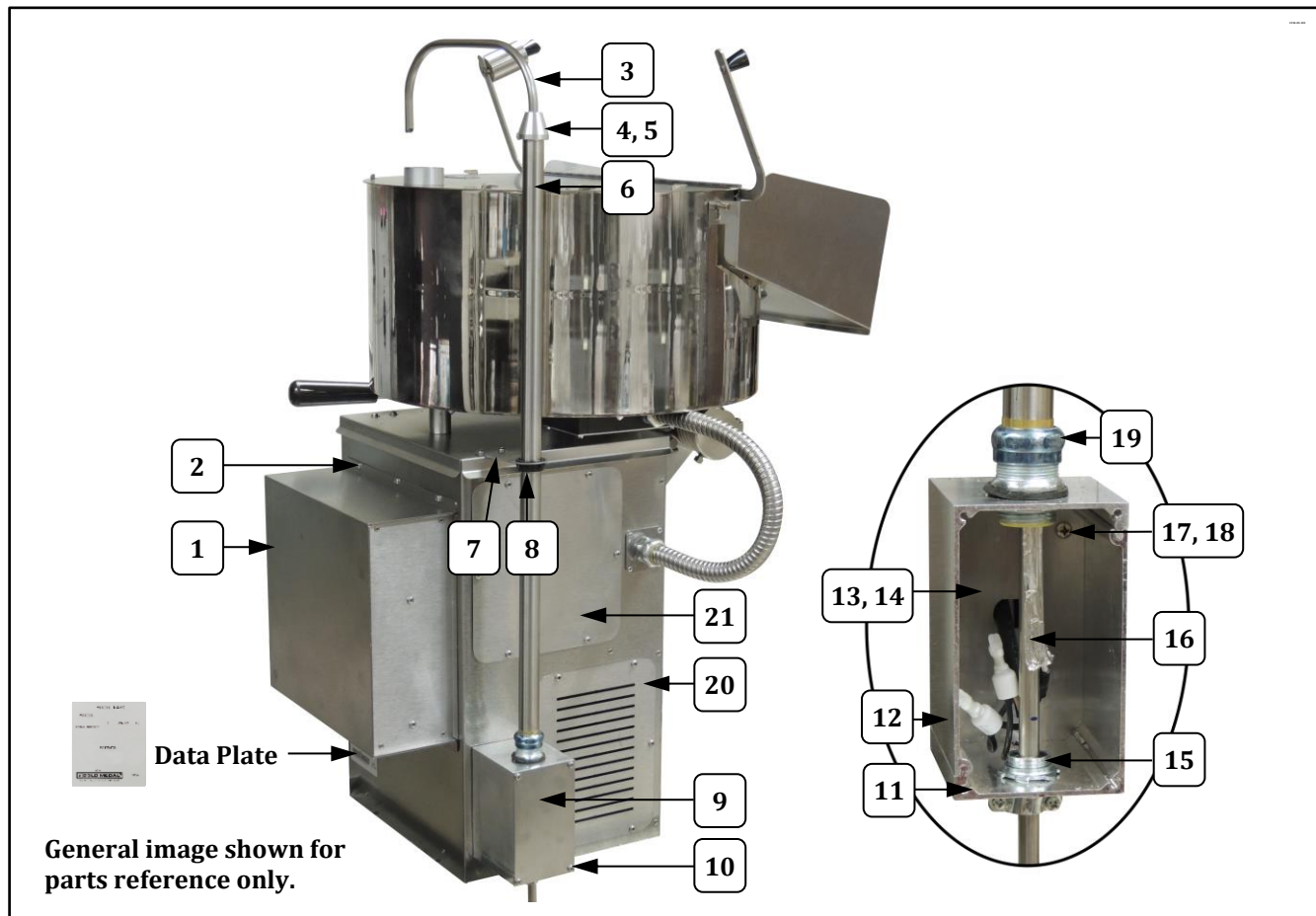

Item	Part Description	Part Number	
		36 and 48 oz.	60 oz.
1	CONTROL BOX COVER	111528	111528
2	SCREW #8-32X3/8 PAN HD PH	74141	74141
3	OIL DELIVERY TUBE	111517	111518
4	SPOUT SET COLLAR	17891	17891
5	8-32 X 1/4 PHIL PAN M/S	87314	87314
6	26 IN SS TUBE	17900	17900
7	HEATED OIL LINE BRACKET	111537	111537
8	BUSHING, SNAP 1.125 IN	82221	82221
9	TOP LID	17899	17899
10	8-32 X 1/2 PHIL PAN M/S	47141	47141
11	JUNCTION BOX BOTTOM	111536	111536
12	JUNCTION BOX TOP	111535	111535
13	BOTTOM JUNCTION BOX LID	17672	17672
14	8-32X3/8 FL HD PH MS	20065	20065
15	STRAIN RELIEF T&B 3302	89045	89045
16	16W FOIL HEAT ELEMENT	17898	17898
17	8-32 X 3/8 PAN HD PH M/S	12389	12389
18	8-32 SERRATED FLANGE NUT	61151	61151
19	3/4" EMT CONNECTOR	17892	17892
20	PEDESTAL EXHAUST COVER	111539	111539
21	PEDESTAL REAR COVER	111538	111538

Unit Exterior – Kettle Mount – Parts Breakdown

General images shown for parts reference only.

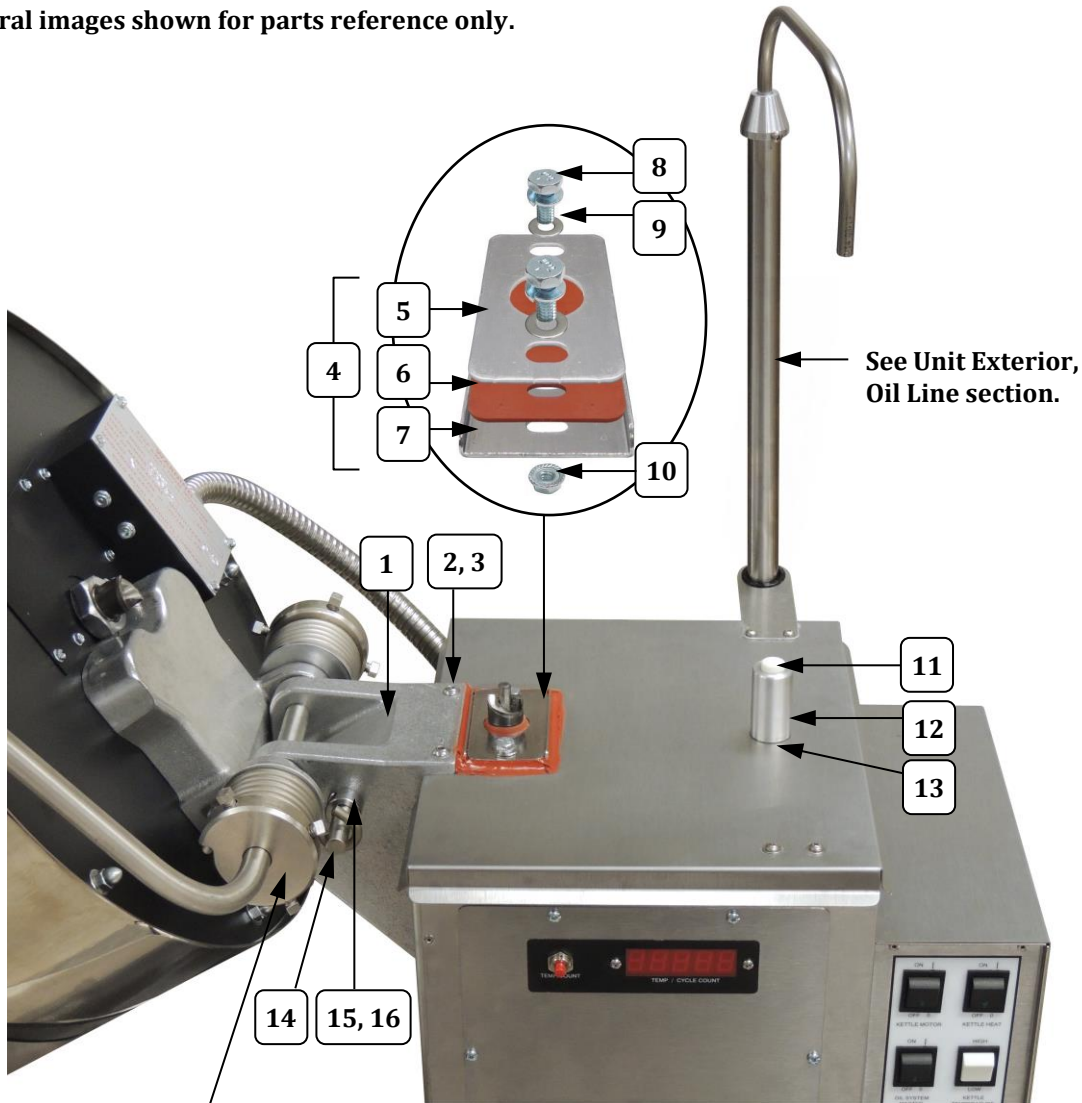

See Unit Exterior,
Oil Line section.

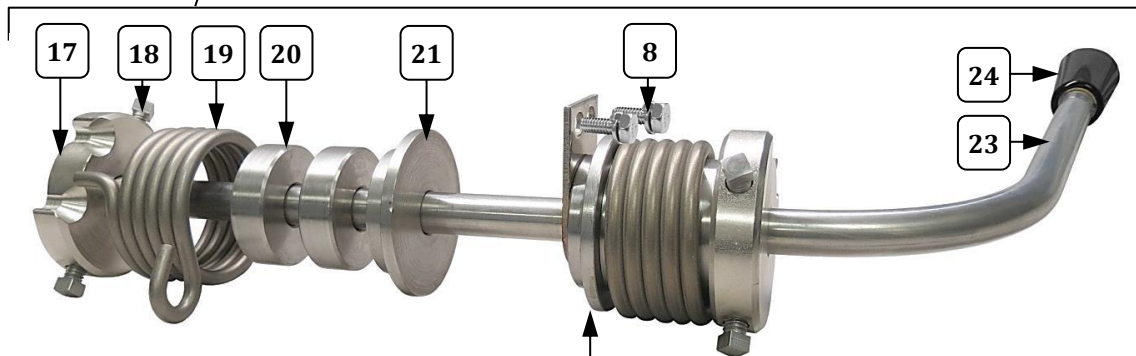

RH Dump Handle shown for parts reference
(see next page for Pass Thru Handle)

*NOTE: Concave side of Large Spacer fits up
against bracket weld on Dump Bar Shaft.

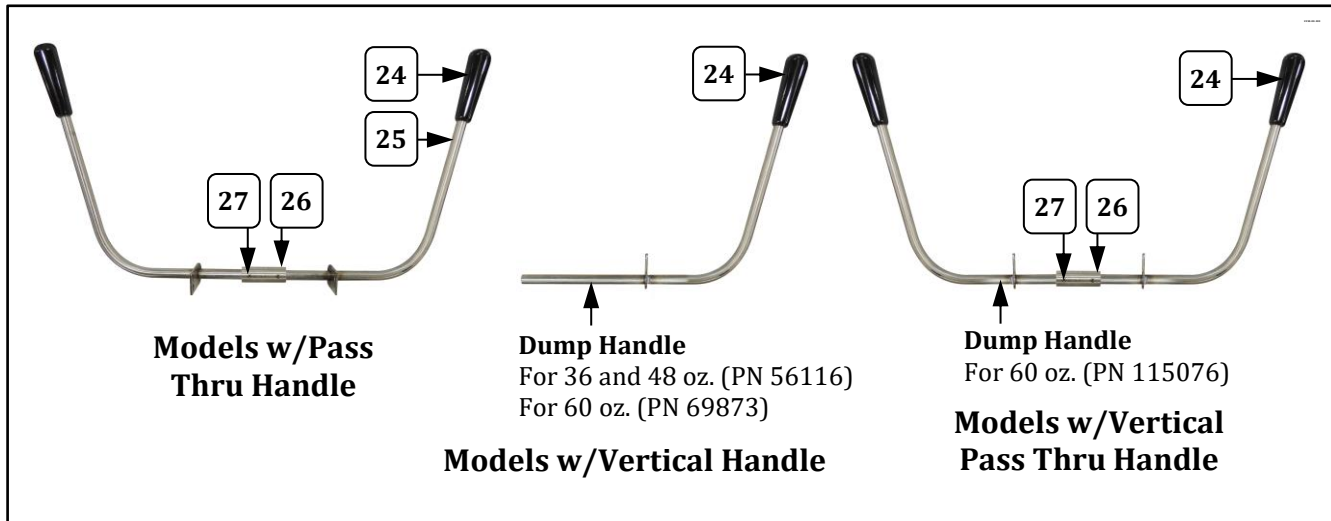

Item	Part Description	Part Number			
		RH Units	LH Units	RH Pass Thru	LH Pass Thru
1	BOT KETTLE PIVOT MACHINED	106060	106060	106060	106060
2	1/4-20x3/4 BUTTON HD SC	67927	67927	67927	67927
3	HEX NUT 1/4-20 ESLOK	42361	42361	42361	42361
4	ADJUSTING PLATE,WELD ASSY (includes Flat Plate, Agitator Seal, and Formed Bottom Plate)	82099	82099	82099	82099
6	PLATE/FLAT	82328	82328	82328	82328
6	AGITATOR SEAL	79437	79437	79437	79437
7	FORMED BTM PLATE	83300	83300	83300	83300
8	1/4-20 X 3/4 GRADE 5 BOLT	74520	74520	74520	74520
9	FLAT WASHER 1/4 STAINLESS	87261	87261	87261	87261
10	1/4-20 SERRATED LOCK NUT	46311	46311	46311	46311
11	KETTLE REST BUMPER	83111	83111	83111	83111
12	KETTLE REST (aluminum)	83110	83110	83110	83110
13	1/4-20X3/4 LG HEX HD BOLT	13164	13164	13164	13164
14	SPRING RETAINER ROD	82551	82551	82551	82551
15	SET COLLAR 1/2ID X 7/8OD	47326	47326	47326	47326
16	SET SCREW 1/4-20 X 3/16 (1 req'd. per collar)	47751	47751	47751	47751
17	COLLAR	74661	74661	74661	74661
18	5/16-18 X 1.25 SQ HD CP	40785	40785	40785	40785
19	TORSION SPRING	74660	74660	74660	74660
20	SPACER	74658	74658	74658	74658
21	SPACER,LARGE (CUSTOMER SIDE)	74690	74690	74690	74690
22	SPACER,LARGE (DUMP SIDE) - Concave side fits up against bracket weld on Dump Bar Shaft	74659	74659	74659	74659
23	DUMP LEVER ASSY, RIGHT	82253			
	DUMP LEVER ASSY, LEFT		82276		
24	PLASTIC HANDLE	57028	57028	57028	57028
25	DUMP HANDLE RH PASS THRU			82685	82685
	DUMP HANDLE LH PASS THRU			82686	82686
26	COUPLING DUMP LEVER			82688	82688
27	SET SCREW 1/4-20 X 1/4			46610	46610

Kettle Assembly (36, 48, and 60 oz.) – Parts Breakdown

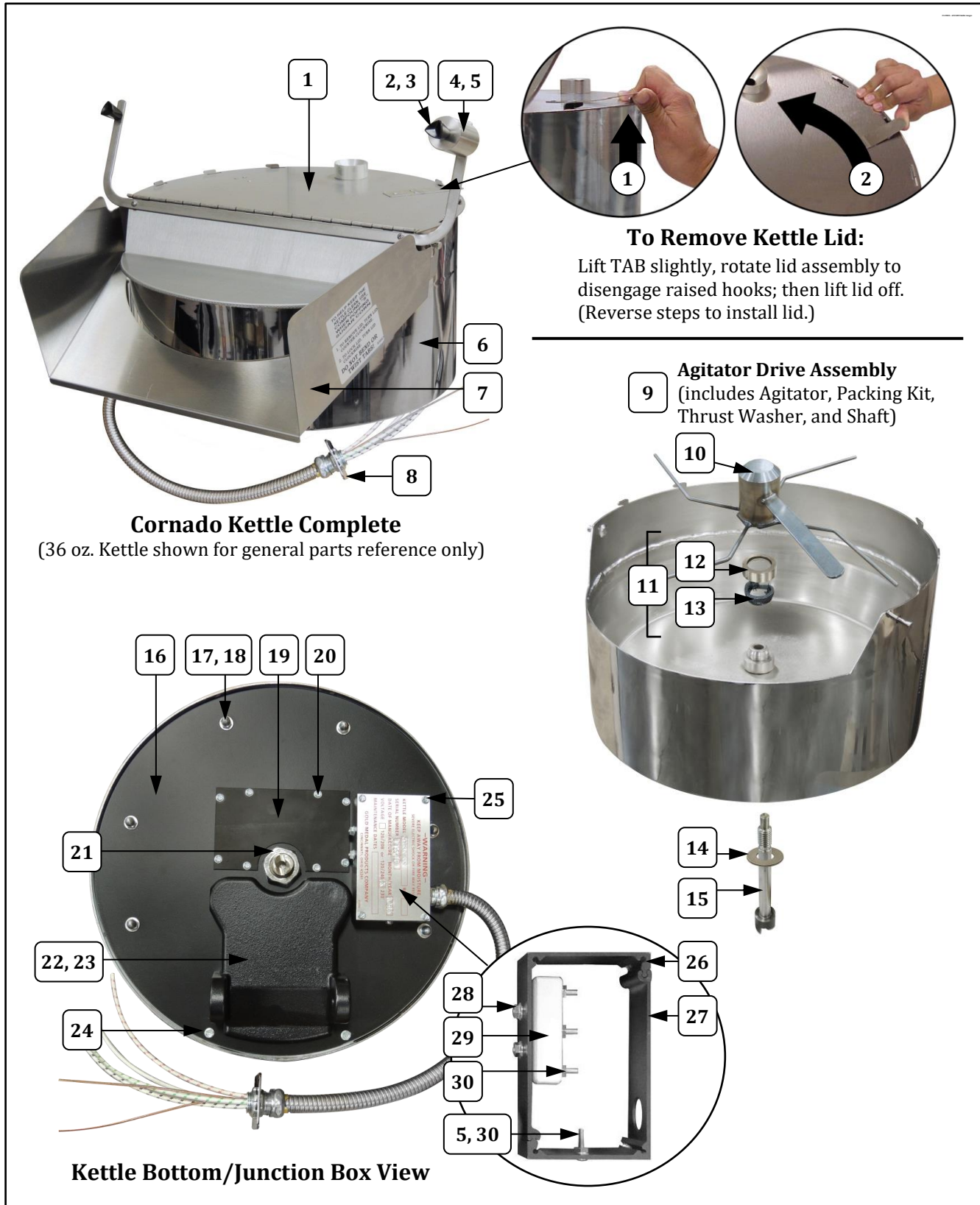



Kettle Assembly (36, 48, and 60 oz.) – Parts List

Item	Part Description	Part Number		
		36 oz. 111608-00	48 oz. 111607-00	60 oz. 111606-00
1	KETTLE LID ASSEMBLY	83044	83046	83320
2	KNOB LID LIFT	47120	47120	47120
3	8-32 X 1" CUP PT SOC SET	77933	77933	77933
4	COUNTER WEIGHT	83114	83114	83114
5	8-32 X 1/2 PHIL PN M/S SS	42226	42226	42226
6	CORNADO KETTLE BOTTOM (see Element View for additional parts breakdown)	69551	69554	83318
7	KETTLE DUMP CHUTE ASSY	82636	82830	83304
8	KETTLE LEAD ASSY	111601	111596	111596
9	AGITATOR DRIVE ASSY (includes Agitator, Packing Kit, Thrust Washer, and Agitator Shaft)	83294	83295	
10	AGITATOR WELDMENT	83292	83293	17668
11	CORNADO PACKING KIT (includes Packing Cage and Packing Cord)	69305	69305	69305
12	PACKING CAGE CORNADO AGIT	69302	69302	69302
13	PACKING CORD 7 IN	69304-7	69304-7	69304-7
14	THRUST WASHER	67852	67852	67852
15	AGITATOR SHAFT	83287	83287	83287
16	KETTLE BASE PLATE	83258	83264	83302
17	ACORN NUT 1/4-20	49068	49068	49068
18	FLAT WASHER 1/4 STAINLESS	87261	87261	87261
19	THERMOSTAT COVER	83267	83267	83267
20	8-32 x 5/16 SLOTTED HEX	49594	49594	49594
21	HEX JAM NUT	82137	82137	82137
22	TOP PIVOT CASTING MACHINED	83281	83281	83281
23	HEX BOLT 3/8-16 X 3/4 (fastens Pivot Casting)	20051	20051	20051
24	10-32 X 1 UNSL NON-IND	49376		
25	8-32 X 1/2 SLOTTED H W H (Screw)	49379	49379	49379
26	JUNCTION BOX TERMINAL SIDE	83261	83261	83261
27	JUNCTION BOX LEAD SIDE	83260	55313	55313
28	8-32 SERRATED FLANGE NUT	61151	61151	61151
29	TERMINAL BLOCK KETTLE	41129	41129	41129
30	8-32 HEX M/S NUT	74149	74149	74149



36 oz. Kettle Bottom – Element View

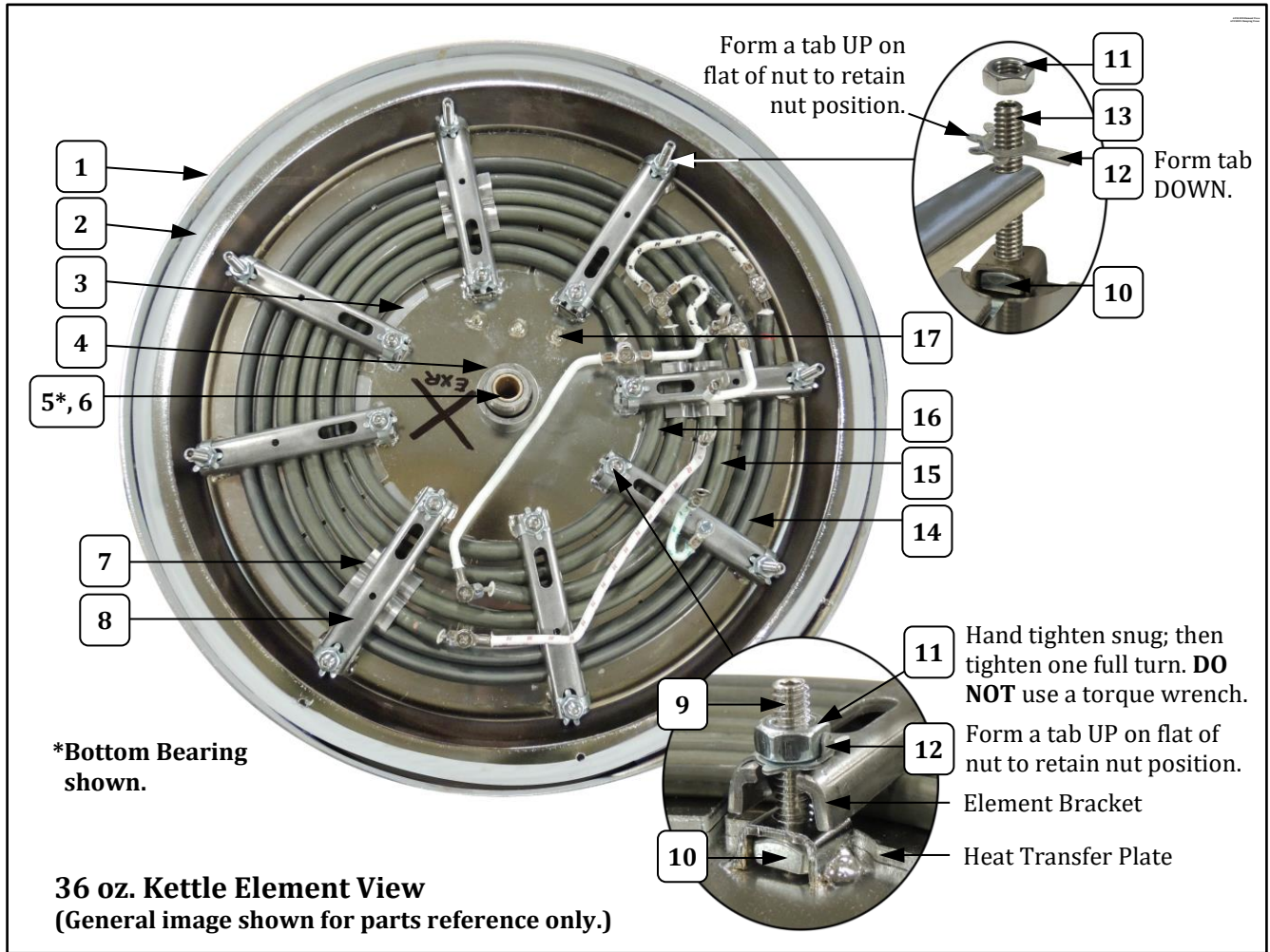

Item	Part Description	Part Number
		111608-00
1	36 oz. CORNADO KETTLE (weldment)	69552
2	KETTLE GASKET	83279
3	TRANSFER PLATE	69337
4	SPACER	83278
5	BEARING, KETTLE HUB (2 required)	82079
6	TOP BEARING	83252
7	ELEMENT SHIM (optional, only used as needed)	68787
8	ELEMENT CLAMP (8 required)	68778
9	1/4-20 X 1.25 SET SCREW	69140
10	1/4-20 RND TOP SQ NUT	69156
11	HEX NUT 1/4-20	74133
12	NUT RETAINER	50190
13	1/4-20 X 1.75 SET SCREW	76444
14	HEAT ELEMENT,1350W	82318
15	TUBULAR ELEMENT, 1800W	48650
16	TUBULAR ELEMENT, 1250W	48801
17	RETAINING NUT (fastens lead to kettle bottom)	41434



48 oz. Kettle Bottom – Element View

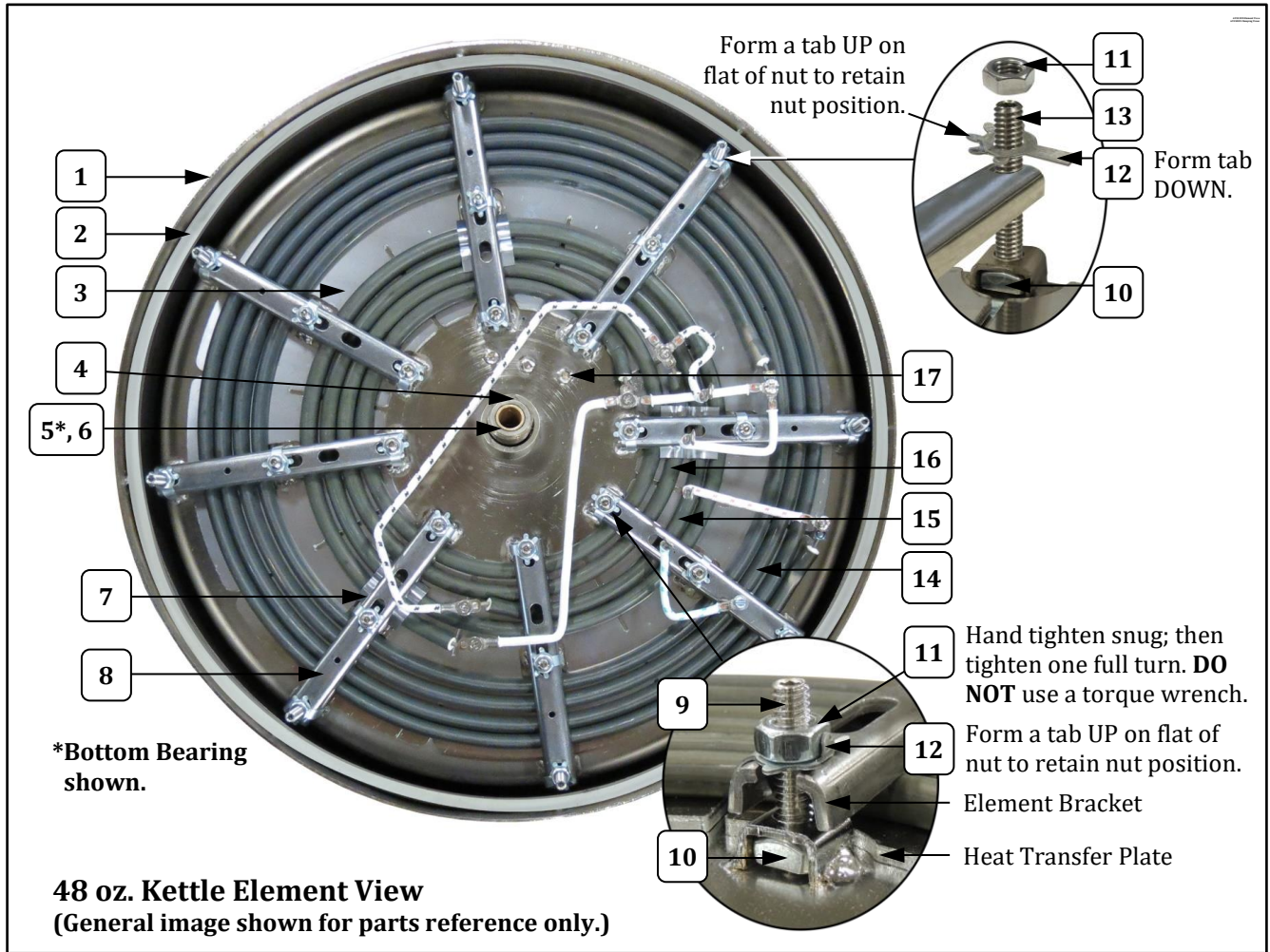

Item	Part Description	Part Number
		111607-00
1	48 oz. CORNADO KETTLE (weldment)	69555
2	KETTLE GASKET	83280
3	TRANSFER PLATE	69336
4	SPACER	83278
5	BEARING, KETTLE HUB (2 required)	82079
6	TOP BEARING	83252
7	ELEMENT SHIM (optional, only used as needed)	68787
8	ELEMENT CLAMP (8 required)	68780
9	1/4-20 X 1.25 SET SCREW	69140
10	1/4-20 RND TOP SQ NUT	69156
11	HEX NUT 1/4-20	74133
12	NUT RETAINER	50190
13	1/4-20 X 1.75 SET SCREW	76444
14	HEAT ELEMENT, 2700W	82597
15	TUBULAR ELEMENT, 1500W	48800
16	TUBULAR ELEMENT, 1050W	48651
17	RETAINING NUT (fastens lead to kettle bottom)	41434



60 oz. Kettle Bottom – Element View

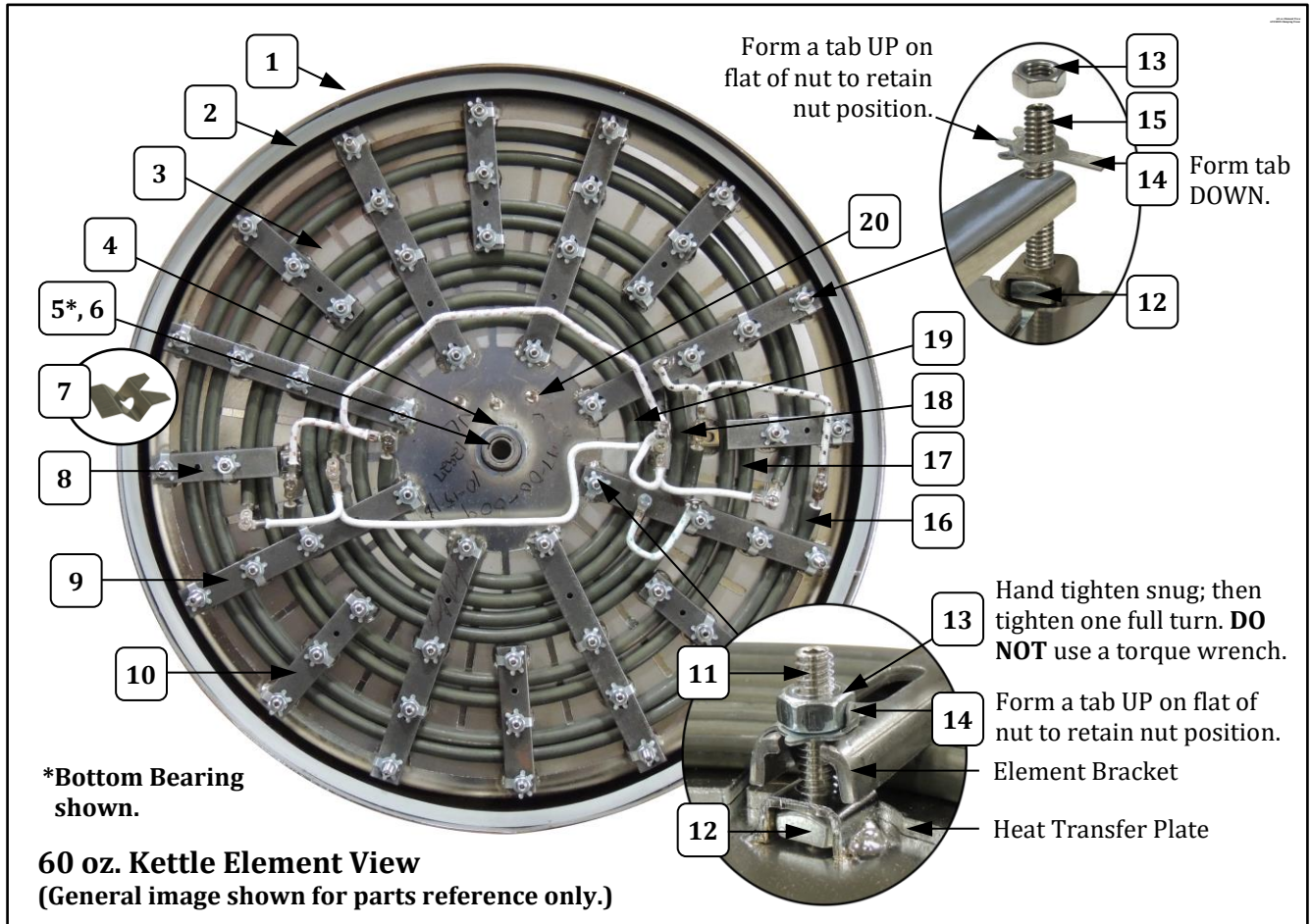

Item	Part Description	Part Number
		111606-00
1	60 oz. CORNADO KETTLE (weldment)	83301
2	KETTLE GASKET	83315
3	TRANSFER PLATE	68053
4	SPACER	83278
5	BEARING, KETTLE HUB (2 required)	82079
6	TOP BEARING	83252
7	ELEMENT SHIM (optional, only used as needed)	68787
8	ELEMENT CLAMP (medium clamp; 6 required)	83317
9	ELEMENT CLAMP (large clamp; 8 required)	83316
10	ELEMENT CLAMP (small clamp; 2 required)	83349
11	1/4-20 X 1.25 SET SCREW	69140
12	1/4-20 RND TOP SQ NUT	69156
13	HEX NUT 1/4-20	74133
14	NUT RETAINER	50190
15	1/4-20 X 1.75 SET SCREW	76444
16	TUBULAR ELEMENT 2300W	68052
17	TUBULAR ELEMENT 1850W	68051
18	500W HEAT ELEMENT	68106
19	TUBULAR ELEMENT, 1050W	48651
20	RETAINING NUT (fastens lead to kettle bottom)	41434



Pedestal Interior – Motor and Shaft

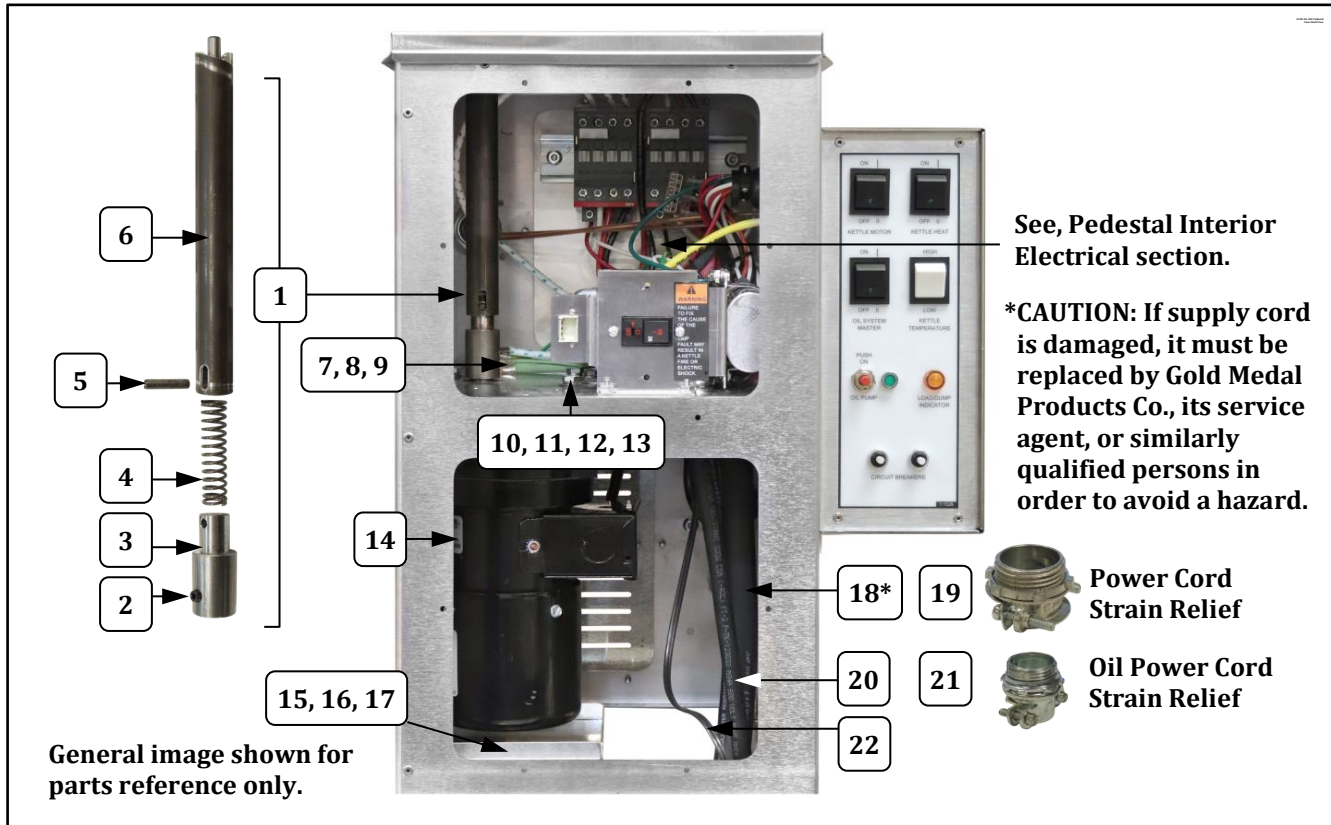

Item	Part Description	Part Number	
		36 oz.	48 and 60 oz.
1	LOWER AGIT DR SHAFT ASSY (complete assy. includes coupler, set screw, spring, shaft and pin)	82496	82496
2	SET SCREW 1/4-28 X 1/4	82067	82067
3	COUPLING, DRIVE MOTOR	82287	82287
4	SPRING OUTPUT COUPLING	74013	74013
5	SPRING PIN 3/16 X 7/8	82421	82421
6	LOWER AGIT DRIVE SHAFT	82447	82447
7	8-32 X 1 PH PAN M/S S.S. (ground fastener)	12219	12219
8	#8 INT. TOOTH L/W 410SS (ground fastener)	12132	12132
9	HEX NUT #8-32 STAINLESS (ground fastener)	89129	89129
10	1/4-20 X 3/4 GRADE 5 BOLT	74520	74520
11	N/A		
12	FLAT WASHER 1/4 STAINLESS	87261	87261
13	N/A		
14	KETTLE DRIVE MOTOR	82085B	82085B
15	BAFFLE	111909	111909
16	8-32 X 3/8 PAN HD PH M/S	12389	12389
17	8-32 SERRATED FLANGE NUT	61151	61151
18	POWER SUPPLY CORD ASSEMBLY	82209	82260
19	STRAIN RELIEF T&B 3304	82227	82227
20	WIRE HARNESS,OIL PUMP	41499	41499
21	STRAIN RELIEF T&B 3302	89045	89045
22	EXHST BLOWER PLUG & CORD	47199	47199

Pedestal Interior – Electrical – Parts Breakdown

*Temp/Cycle Count Board displays either Fahrenheit (°F) or Celsius (°C) depending on jumper placement (qualified service personnel set jumper placement when board is installed).

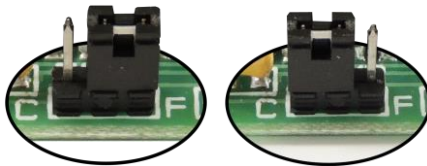

*Jumper set to Fahrenheit

*Jumper set to Celsius

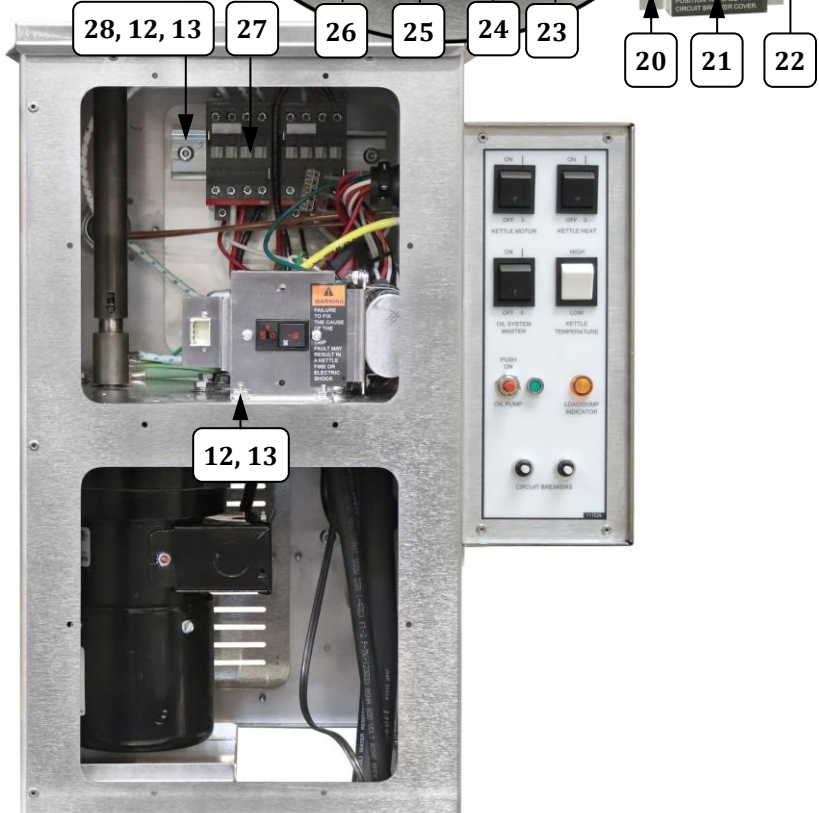
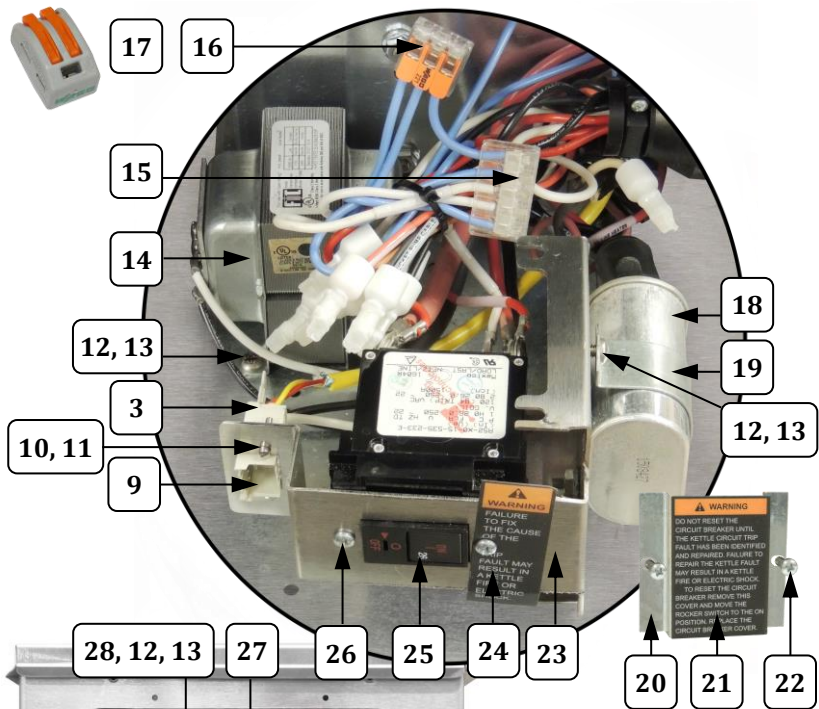
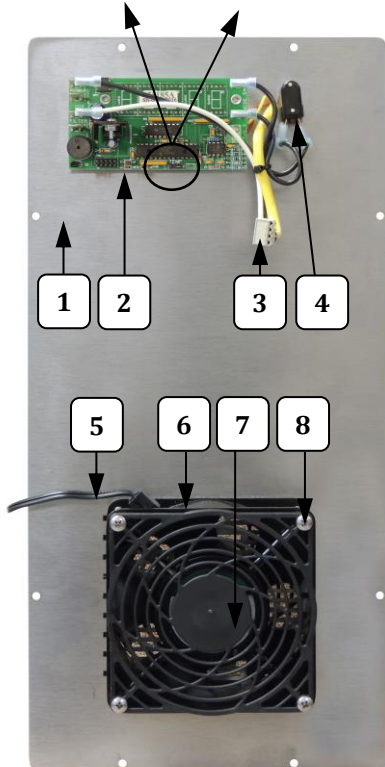

Pedestal Interior (Front Cover Removed) - General images shown for parts reference only.



Pedestal Interior – Electrical – Parts List

Item	Part Description	Part Number
		All Models
1	PEDESTAL FRONT COVER	111540
2	COUNT AND TEMP DISPLAY	55185
3	FEMALE CONNECTOR	111628
4	SWITCH OIL PUMP	41031
5	EXHST BLOWER PLUG & CORD	47199
6	EXHAUST BLOWER	48018
7	FINGER GUARD	47200
8	10-24 X 5/8 PHIL PAN M/S	76000
9	MALE CONNECTOR W/FLANGES	111627
10	3-48X1/2 SS SLOTTED SCREW	111804
11	3-48 SS HEX NUT	111805
12	8-32 X 3/8 PAN HD PH M/S	12389
13	8-32 SERRATED FLANGE NUT	61151
14	TRANSFORMER, 12/24 VOLT	39459
15	5 POSITION WIRE CONNECTOR	55245
16	3 POSITION WIRE CONNECTOR	55244
17	2 POSITION WIRE CONNECTOR	55621
18	7.5 MFD CAPACITOR	46107
19	CAPACITOR STRAP	48301
20	CIRCUIT BREAKER COVER	55253
21	CB WARNING LABEL	55252
22	SCREW #8-32X1/4 PAN HD PH	74142
23	CIRCUIT BREAKER BRACKET	114176
24	CB INFORMATION LABEL	55251
25	CIRCUIT BREAKER, 26A	55223
26	6-32 X 3/16 PH PAN M/S	38149
27	IEC CONTACTOR 3 POLE 25A	55564
28	4IN DIN RAIL	48604

Control Box/Control Panel – Parts Breakdown

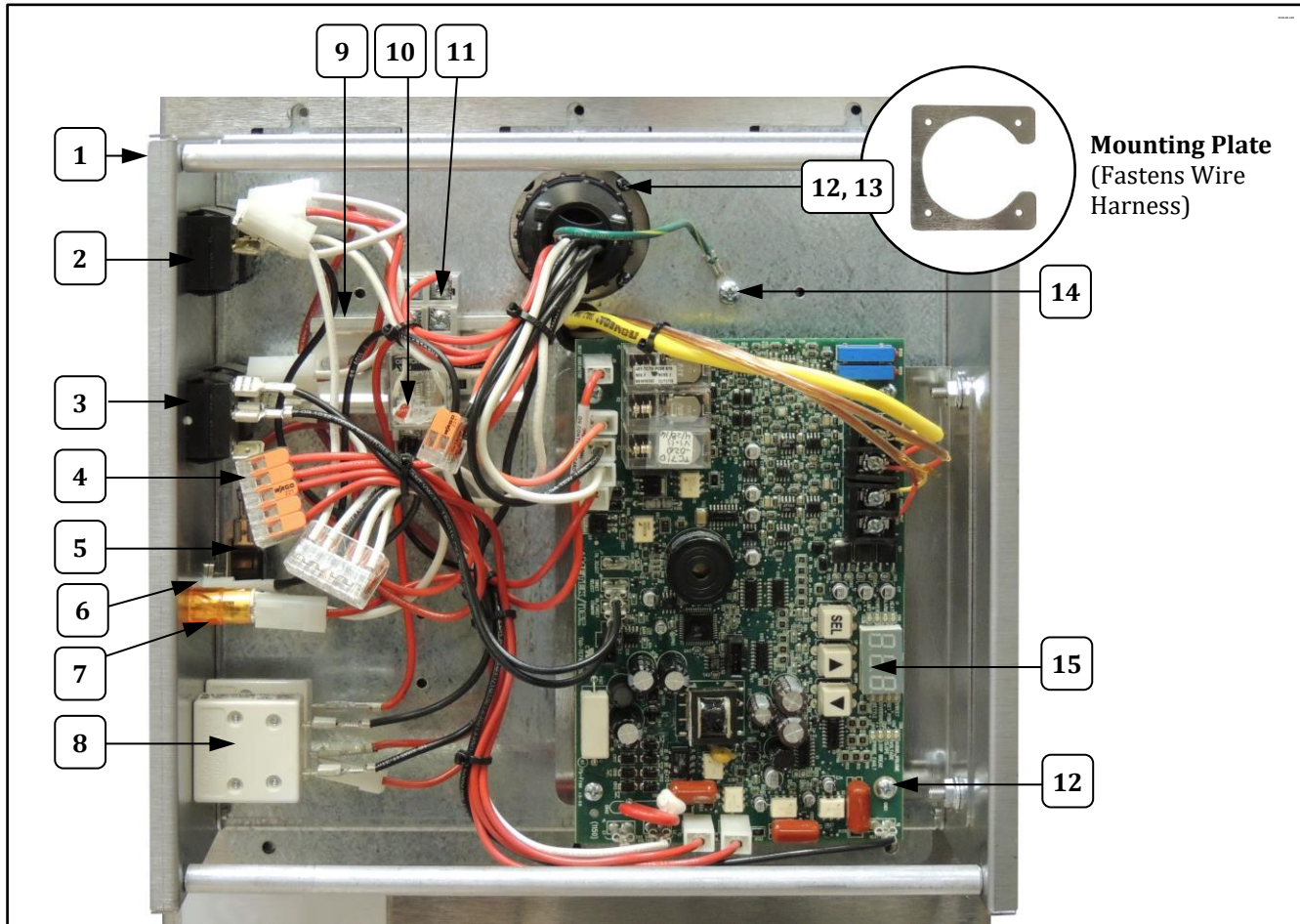

Control Box Interior View

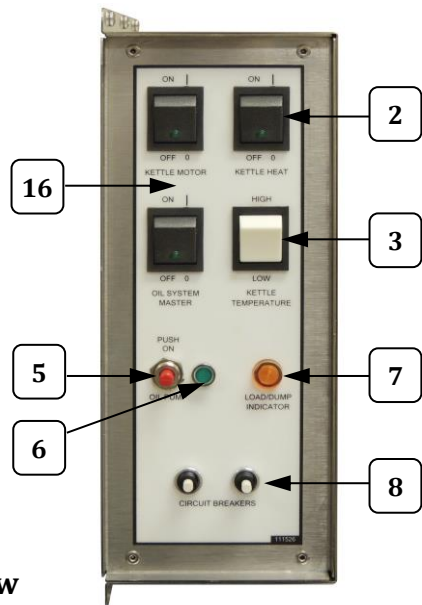

Control Panel Exterior View

General images shown for parts reference only.



Control Box/Control Panel – Parts List

Item	Part Description	Part Number	
		RH Units	LH Units
1	CONTROL BOX (includes supports; order cover and label separately)	111519	111520
2	SWITCH, LIGHTED ROCKER GR	42798	42798
3	SWITCH, ROCKER DPDT	48615	48615
4	5 POSITION WIRE CONNECTOR	55245	55245
5	SWITCH OIL PUMP	41031	41031
6	PILOT LIGHT, GREEN	48660	48660
7	PILOT LIGHT, AMBER	55039	55039
8	CIRCUIT BREAKER, 15A	47364	47364
9	4IN DIN RAIL	111532	111532
10	RELAY, DPDT	55036	55036
11	RELAY SOCKET 2 POLE	89085	89085
12	6-32 X 5/8 PAN PHILLIPS - Screw	77069	77069
13	MOUNTING PLATE (fastens wire harness)	114175	114175
14	SCREW #8-32X3/8 PAN HD PH	74141	74141
15	TEMP CONTROL DIGITAL	41002	41002
16	LABEL, CORNADO CONTROLS	111526	111526

Safety Labels

Unit Exterior Labels

Unit Interior Label

Power Cord Label

Item	Part Description	Part Number
		All Models
1	UNIVERSAL ELEC LABEL	105007
2	WARNING LABEL	68805
3	KETTLE LABEL	83047
4	CB INFORMATION LABEL	55251
5	CB WARNING LABEL	55252
6	MAIN GROUND LABEL	42375
7	WARNING LABEL CORD	68720



Accessories



Item	Part Description	Part Number		
		36 oz.	48 oz.	60 oz.
1	36OZ CORN CUP ASSEMBLY	67905-36		
	48OZ CORN CUP ASSEMBLY		17757-48	
	60OZ CORN CUP ASSEMBLY			17757-60
2	FLAVACOL CONT WELDMENT	41752	41752	41752
3	PERF JET SCOOP REGULAR RH	2072	2072	2072
4	MEASURE 2 TBS, 29.6cc (Flavacol measure)	47681		
5	MEASURE 1/4 CUP (Flavacol measure)		47169	47169
6	RECPT,30A-125/250 VOLT	82208		
7	RECEPTACLE 50AMP		82920	82920



Wiring Diagram

**For wiring information, please reference
the Wiring Diagram shipped with the popper.**



WARRANTY

Gold Medal Products Co. warrants to the original purchaser each item of its manufacture to be free of defects in workmanship and material under normal use and service. Gold Medal Products Co.'s obligation under this warranty is limited solely to repairing or replacing parts, f.o.b. Cincinnati, Ohio, which in its judgment are defective in workmanship or material and which are returned, freight prepaid, to its Cincinnati, Ohio factory or other designated point. Except for "Perishable Parts" on specific machines, the above warranty applies for a period of two (2) years from the date of original sale to the original purchaser of equipment when recommended operating instructions and maintenance procedures have been followed. These are packed with the machine. Parts warranty is two (2) years, labor is six (6) months.

THIS WARRANTY IS IN LIEU OF ALL OTHER WARRANTIES EXPRESSED OR IMPLIED, AND OF ALL OTHER OBLIGATIONS OR LIABILITIES ON OUR PART, INCLUDING THE IMPLIED WARRANTY OF MERCHANTABILITY. THERE ARE NO WARRANTIES WHICH EXTEND BEYOND THE DESCRIPTION ON THE FACE HEREOF. In no event shall Gold Medal Products Co. be liable for special, incidental or consequential damages. No claim under this warranty will be honored if the equipment covered has been misused, neglected, damaged in transit, or has been tampered with or changed in any way. No claim under this warranty shall be honored in the event that components in the unit at the time of the claim were not supplied or approved by Gold Medal Products Co. This warranty is effective only when electrical items have been properly attached to city utility lines only at proper voltages. This warranty is not transferable without the written consent of Gold Medal Products Co.

The term "Original Purchaser" as used in this warranty shall be deemed to mean that person, firm, association, or corporation who was billed by the GOLD MEDAL PRODUCTS CO., or their authorized distributor for the equipment.

THIS WARRANTY HAS NO EFFECT AND IS VOID UNLESS THE ORIGINAL PURCHASER FIRST CALLS GOLD MEDAL PRODUCTS CO. AT 1-800-543-0862 TO DISCUSS WITH OUR SERVICE REPRESENTATIVE THE EQUIPMENT PROBLEM, AND, IF NECESSARY, FOR INSTRUCTIONS CONCERNING THE REPAIR OR REPLACEMENT OF PARTS.

NOTE: This equipment is manufactured and sold for commercial use only.



GOLD MEDAL[®] PRODUCTS CO.

10700 Medallion Drive, Cincinnati, Ohio 45241-4807 USA

gmpopcorn.com

Phone: (800) 543-0862 Fax: (800) 542-1496
(513) 769-7676 (513) 769-8500