











Dati Tecnici - Specifications

											
	cond	comp. W	ABS. W	Fuse	Kwh/100Kg	l / h	kg	Lbs	kg	Lbs	Ton CO2 equiv.
CS50 A		1161	680	10	32.4	4.60	48	106	56	123	0.50
CS50 W		1161	630	10	20.4	39.7	48	106	56	123	0.43

24h Produzione Ghiaccio - Ice Production

Raffreddamento ad aria - Air Cooled Unit

Temp. aria Air Temp.	Temp. acqua / Water Temp.			
	32°	21°	15°	10°
°C	32°	21°	15°	10°
°F	90°	70°	60°	50°
10°	47	49	50	52
50°	104	108	110	115
21°	41	43	45	47
70°	90	95	99	104
32°	33	35	37	39
90°	73	77	82	86
38°	27	30	32	34
100°	60	66	71	75

Raffreddamento ad acqua - Water Cooled Unit

Temp. aria Air Temp.	Temp. acqua / Water Temp.			
	32°	21°	15°	10°
°C	32°	21°	15°	10°
°F	90°	70°	60°	50°
10°	48	50	52	54
50°	106	110	115	119
21°	44	47	49	51
70°	97	104	108	112
32°	42	45	47	49
90°	93	99	104	108
38°	40	43	45	47
100°	88	95	99	104

Vista frontale
Front view

Vista laterale
Lateral view

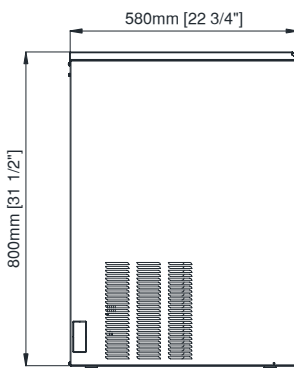
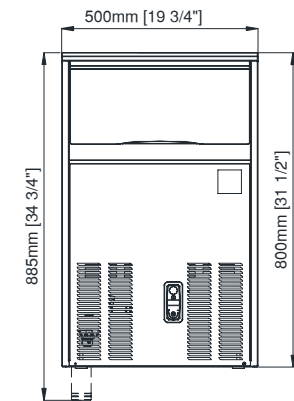

Interruttore ON-OFF
Switch ON-OFF

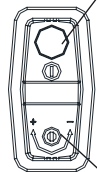

Size ice regulation screw
Vite regolazione
dimensione ghiaccio

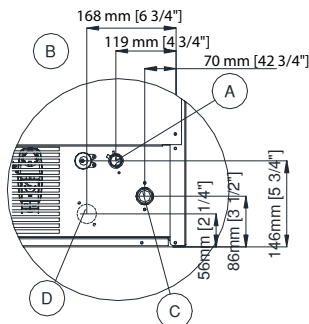
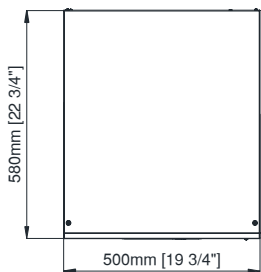

A Electrical cable supply / Ingresso alimentazione elettrica

B Water outlet connection / Attacco scarico acqua diam. 20 mm

C Water inlet connection / Attacco entrata acqua - 3/4" gas

D Water outlet connection water condensation / Uscita acqua condensatore ad acqua diam. 20 mm

Kit 4 Feet Optional
Kit 4 piedini Optional
Ø50mm H100-120 mm



PANNELLO DI CONTROLLO - CONTROL PANEL



Interruttore On/OFF
Switch ON/OFF

Vite regolazione
dimensione ghiaccio
Size ice regulation screw

CAPACITA' DEPOSITO - BIN CAPACITY

22 Kg - 48.5 lbs / 1100 pcs

DIMENSIONI - DIMENSIONS

LxPxH(mm): 500 x 580 x 800

WxDxH(in): 20" 11/16 x 23" 13/16 x 31" 8/16

DATI SPEDIZIONE / SHIPPING DATA

LxPxH(mm): 560 x 600 x 850

WxDxH(in): 22" 1/16 x 25" 3/16 x 38" 13/16

TIPO GHIACCIO - ICE TYPE

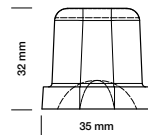

20g

PESO GHIACCIO
WEIGHT ICE

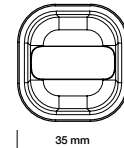

36

PZ / CICLO
PCS / CYCLE

CONDIZIONI USO-OPERATING REQUIREMENTS



220-240V / 50Hz / 1



R134a GWP=1430

MIN

MAX

10°C (50°F)



40°C (104°F)

5°C (41°F)



35°C (95°F)

- 10 %



+ 10 %

1 BAR (14 PSI)



5 BAR (70 PSI)

Calore espulso - Rejected Heat
Volume aria - Air Volume

1750 W
310 m3/h